

C1608C0G2A221K080AA

TDK Item Description : C1608C0G2A221KT****



Application & Main Feature

Commercial Grade (Mid Voltage (100 to 630V))

Series

C1608 [EIA CC0603]

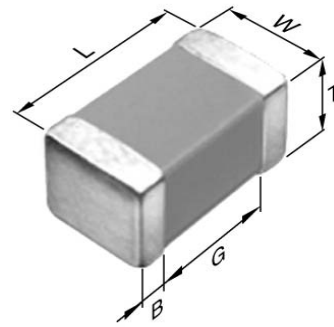

Dimensions

L 1.60mm +/-0.1mm
 W 0.80mm +/-0.1mm
 T 0.80mm +/-0.1mm
 B 0.20mm Min.
 G 0.30mm Min.

Temperature Characteristic

C0G (-55 to 125 degC 0+/-30ppm/degC)

Rated Voltage

2A (100Vdc)

Capacitance

220pF

Capacitance Tolerance

K (+/-10%)

Q Factor

1000 Min.

Insulation Resistance

10Gohm Min.

AEC-Q200

Not Applicable

|Z|, ESR vs. Freq. Characteristics

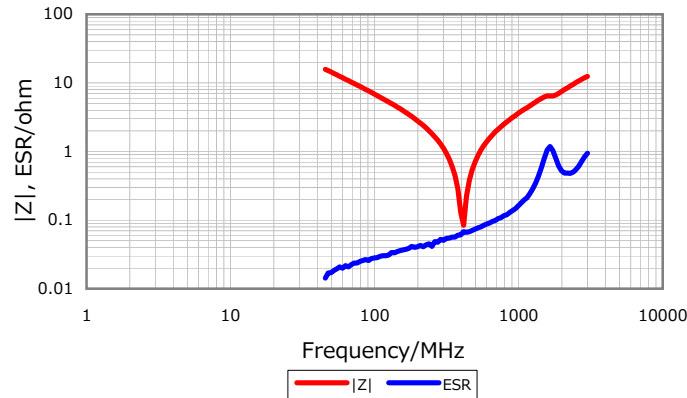

DC Bias Characteristic

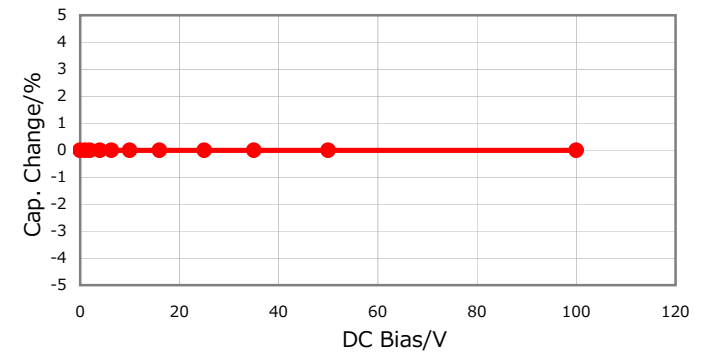

Cap. vs. Freq. Characteristic

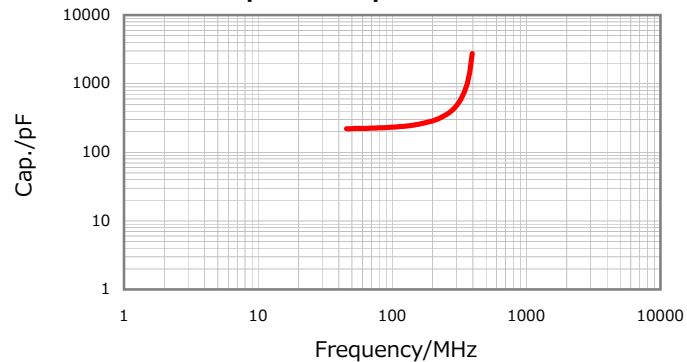

Temperature Characteristics

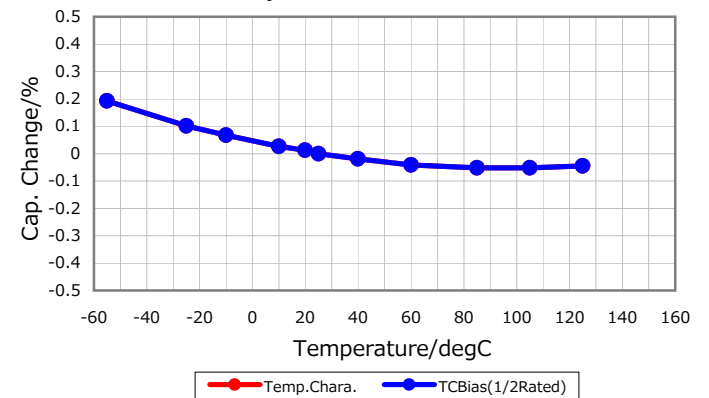

Characterization Sheet (Multilayer Ceramic Chip Capacitors)



All specifications are subject to change without notice.

January 3, 2016