



CERAMIC

Power Splitter/Combiner

SCG-3-262+

Mini-Circuits

3 Way-0°

50Ω

1600 to 2600 MHz

THE BIG DEAL

- Isolation resistor, external 150 ohms
- Low insertion loss, 1.2 dB typ.
- Excellent amplitude unbalance, 0.4 dB typ.
- Excellent phase unbalance, 5 deg. typ.
- High isolation, 17 dB typ.
- ESD non-sensitive
- Temperature stable LTCC technology
- Wrap around terminations for excellent solderability
- Low cost



Generic photo used for illustration purposes only
CASE STYLE: GE0805C-1

+RoHS Compliant

The +Suffix identifies RoHS Compliance. See our web site for RoHS Compliance methodologies and qualifications

APPLICATIONS

- ISM
- WLAN
- Bluetooth

PRODUCT OVERVIEW

Mini-Circuits new LTCC 0° Power Splitter, model SCG-3-262+, offers industry leading combination of operating performance and size. The outstanding phase and amplitude unbalance make this component a versatile building block for use in a variety of systems and sub-system designs.

KEY FEATURES

Feature	Advantages
Small Size	Offered in the package size, SCG-3-262+ offers an industry leading combination of size, power handling, and frequency. The small footprint allows for reduced parasitics in systems with improved performance and simplified layout.
Wrap-Around Terminations	Provides excellent solderability and easy visual inspection.
LTCC Construction	Provides repeatable performance in the rugged, ceramic package well suited for tough environments such as high humidity and temperature extremes.

REV. A
ECO-009562
SCG-3-262+
MCL NY
210901





CERAMIC

Power Splitter/Combiner

SCG-3-262+

Mini-Circuits

ELECTRICAL SPECIFICATIONS AT 25°C

Parameter	Frequency (MHz)	Min.	Typ.	Max.	Unit
Frequency Range		1600		2600	MHz
Insertion Loss, above 4.8 dB	1600 - 2600	—	1.2	1.8	dB
Isolation	1600 - 2600	12.5	17	—	dB
Phase Unbalance	1600 - 2600	—	5	8.5	Degree
Amplitude Unbalance	1600 - 2600	—	0.4	0.85	dB
Return Loss (Input)	1600 - 2600	—	12	—	dB
Return Loss (Output)	1600 - 2600	—	18	—	dB

MAXIMUM RATINGS

Parameter	Ratings
Operating Temperature	-55°C to 100°C
Storage Temperature	-55°C to 100°C
Power Input (as a splitter)	2W* max.

* Derate linearly to 0.7W at 100°C ambient, power input as combiner is limited by rating of external resistor 150Ω resistor. Permanent damage may occur if any of these limits are exceeded.

ELECTRICAL SCHEMATIC

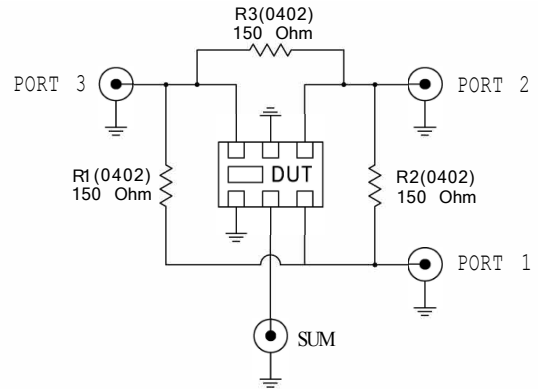



CERAMIC

Power Splitter/Combiner

SCG-3-262+

PAD CONNECTIONS



SUM PORT	2
PORT 1	6
PORT 2	4
PORT 3	3
GROUND	1,5
PORT 1-2, 2-3, 1-3	resistor external 150 ohms

PRODUCT MARKING: SQ

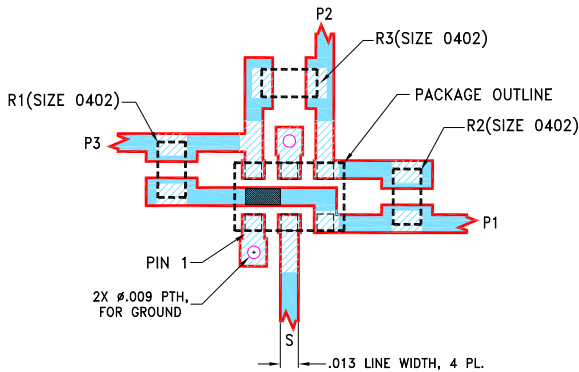
DEMO BOARD MCL P/N: TB-1044+ SUGGESTED PCB LAYOUT (PL-622)



NOTES:

1. LINE WIDTH IS SHOWN FOR ROGERS R04350B WITH DIELECTRIC THICKNESS .0066±.0007. COPPER: 1/2 OZ. EACH SIDE. FOR OTHER MATERIALS LINE WIDTH MAY NEED TO BE MODIFIED.
 2. UNIT FOOT PRINT IS OPTIMIZED FOR PERFORMANCE AND IS DIFFERENT FROM CASE STYLE GE0805C-1 RECOMMENDATIONS.
 3. CHIP COMPONENT FOOT PRINT IS SHOWN FOR REFERENCE. FOR COMPONENT VALUE REFER TO TB-1044+.
 4. BOTTOM SIDE OF THE PCB IS CONTINUOUS GROUND PLANE.
-  DENOTES PCB COPPER LAYOUT WITH SMOBC (SOLDER MASK OVER BARE COPPER).
-  DENOTES COPPER LAND PATTERN FREE OF SOLDER MASK.

OUTLINE DRAWING

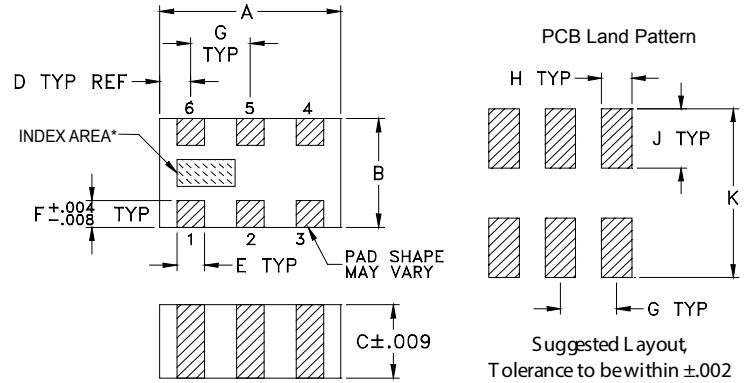

*Shape of index marking may vary

OUTLINE DIMENSIONS (Inches/mm)

A	B	C	D	E	F
.079	.049	.033	.014	.012	.012
2.01	1.24	0.84	0.36	0.30	0.30
G	H	J	K		wt
.026	.014	.039	.110		grams
0.66	0.36	1.00	2.80		.008



CERAMIC

Power Splitter/Combiner

SCG-3-262+

TYPICAL PERFORMANCE DATA

Frequency (MHz)	Total Loss ¹ (dB)			Amplitude Unbalance (dB)	Isolation (dB)			Phase Unbalance (deg.)	Return Loss (dB)		
	S-1	S-2	S-3		1-2	1-3	2-3		S	1	2
1600	5.42	5.85	5.94	0.53	14.86	14.43	15.07	0.79	9.14	27.90	33.33
1650	5.39	5.80	5.90	0.51	15.52	15.01	15.59	0.64	9.48	28.05	38.46
1700	5.36	5.75	5.85	0.49	16.22	15.62	16.15	0.41	9.83	27.76	49.81
1750	5.33	5.70	5.80	0.47	17.00	16.30	16.76	0.23	10.27	27.01	44.63
1800	5.31	5.65	5.75	0.45	17.85	17.03	17.43	0.19	10.75	26.20	36.91
1850	5.27	5.59	5.70	0.42	18.83	17.85	18.17	0.38	11.30	25.34	33.26
1900	5.25	5.54	5.64	0.39	19.92	18.75	18.99	0.64	11.94	24.61	30.86
1950	5.23	5.48	5.59	0.36	21.24	19.82	19.94	0.88	12.72	23.93	29.38
2000	5.21	5.44	5.54	0.33	22.80	21.02	21.02	1.14	13.63	23.41	28.34
2100	5.19	5.35	5.45	0.26	27.33	24.13	23.73	1.68	16.06	22.55	26.60

1. Total Loss = Insertion Loss + 4.8dB splitter loss.

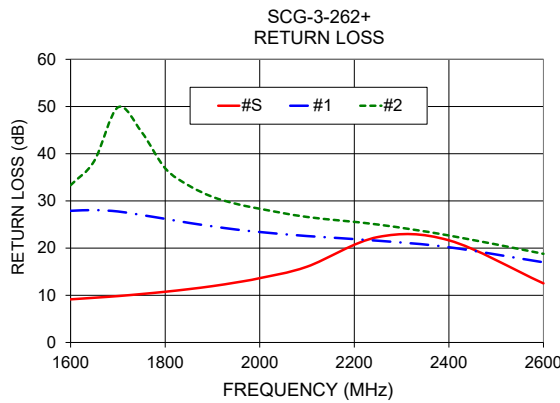
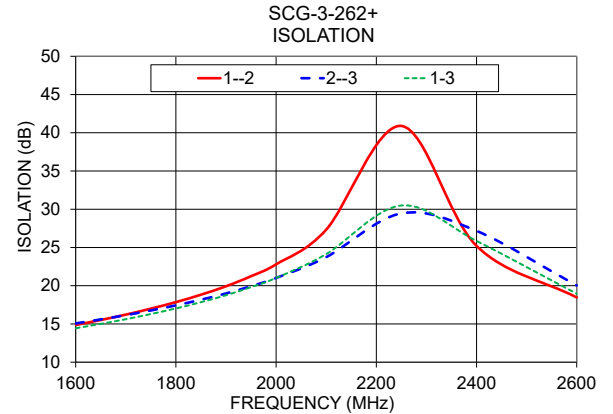
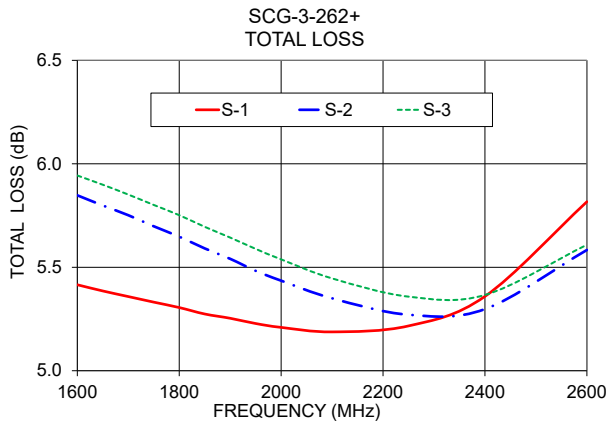

- NOTES**
- A. Performance and quality attributes and conditions not expressly stated in this specification document are intended to be excluded and do not form a part of this specification document.
 - B. Electrical specifications and performance data contained in this specification document are based on Mini-Circuit's applicable established test performance criteria and measurement instructions.
 - C. The parts covered by this specification document are subject to Mini-Circuits standard limited warranty and terms and conditions (collectively, "Standard Terms"); Purchasers of this part are entitled to the rights and benefits contained therein. For a full statement of the standard. Terms and the exclusive rights and remedies thereunder, please visit Mini-Circuits' website at www.minicircuits.com/MCLStore/terms.jsp

