

FAST RECOVERY RECTIFIER DIODES

MAIN PRODUCT CHARACTERISTICS

$I_{F(AV)}$	8 A
V_{RRM}	400 V
$V_F(\max)$	1.4 V
$t_{rr}(\max)$	35 ns

FEATURES AND BENEFITS

- VERY LOW REVERSE RECOVERY TIME
- VERY LOW SWITCHING LOSSES
- LOW NOISE TURN-OFF SWITCHING
- INSULATED PACKAGE: TO-220AC
Insulation voltage: 2500 V_{RMS}
Capacitance = 7 pF

DESCRIPTION

This single rectifier is suited for Switch Mode Power Supplies and other power converters.

This device is intended to free-wheeling function in converters and motor control circuits.

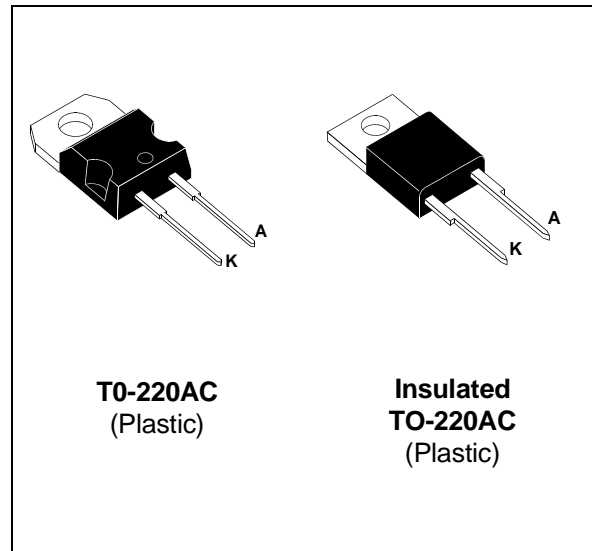

ABSOLUTE RATINGS (limiting values)

Symbol	Parameter		Value	Unit	
V_{RRM}	Repetitive peak reverse voltage		400	V	
I_{FRM}	Repetitive peak forward current	$t_p=5 \mu s$ $F=5kHz$	200	A	
$I_{F(RMS)}$	RMS forward current		16	A	
$I_{F(AV)}$	Average forward current	TO-220AC	$T_c = 120^\circ C$ $\delta = 0.5$	8	A
		Insulated TO-220AC	$T_c = 105^\circ C$		
I_{FSM}	Surge non repetitive forward current	$t_p = 10 ms$ Sinusoidal	100	A	
T_{stg}	Storage temperature range		- 40 to + 150	$^\circ C$	
T_j	Maximum operating junction temperature		150	$^\circ C$	

BYT08P-400 / BYT08PI-400

THERMAL RESISTANCES

Symbol	Parameter	Value	Unit
R _{th(j-c)}	Junction to case	TO-220AC	2.5
		Ins. TO-220AC	3.5

STATIC ELECTRICAL CHARACTERISTICS

Symbol	Parameter	Test Conditions	Min.	Typ.	Max.	Unit
V _F *	Forward voltage drop	T _j = 25°C			1.5	V
		T _j = 100°C			1.4	
I _R **	Reverse leakage current	T _j = 25°C	V _R = V _{RRM}		15	μA
		T _j = 100°C			2.5	mA

Pulse test : * tp = 380 μs, δ < 2%

** tp = 5 ms, δ < 2%

To evaluate the conduction losses use the following equation:

$$P = 1.1 \times I_{F(AV)} + 0.024 I_{F(RMS)}^2$$

RECOVERY CHARACTERISTICS

Symbol	Test Conditions	Min.	Typ.	Max.	Unit
t _{rr}	T _j = 25°C			75	ns
	I _F = 1A V _R = 30V dI _F /dt = - 15A/μs I _F = 0.5A I _R = 1A I _{rr} = 0.25A			35	

TURN-OFF SWITCHING CHARACTERISTICS

Symbol	Parameter	Test Conditions	Min.	Typ.	Max.	Unit
t _{IRM}	Maximum reverse recovery time	dI _F /dt = - 32 A/μs		50	75	ns
		dI _F /dt = - 64 A/μs				
I _{RM}	Maximum reverse recovery current	dI _F /dt = - 32 A/μs		2.8	2.2	A
		dI _F /dt = - 64 A/μs				
C = $\frac{V_{RP}}{V_{CC}}$	Turn-off overvoltage coefficient	T _j = 100°C V _{CC} = 60V I _F = I _{F(AV)} dI _F /dt = - 30A/μs L _p = 1μH		3.3		/

Fig. 1: Average forward power dissipation versus average forward current .

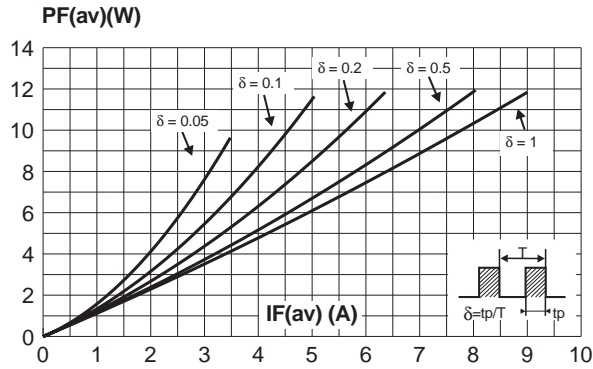

Fig. 2: Peak current versus form factor.

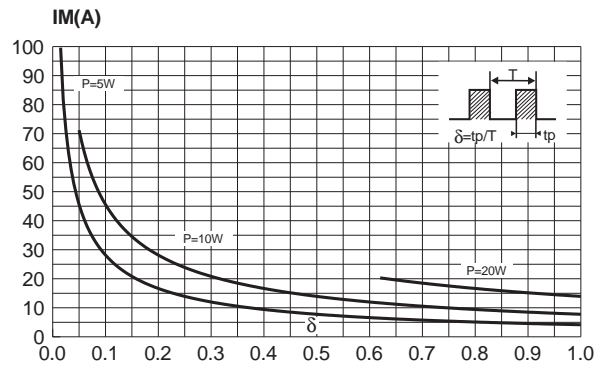

Fig. 3: Average forward current versus ambient temperature ($\delta=0.5$).

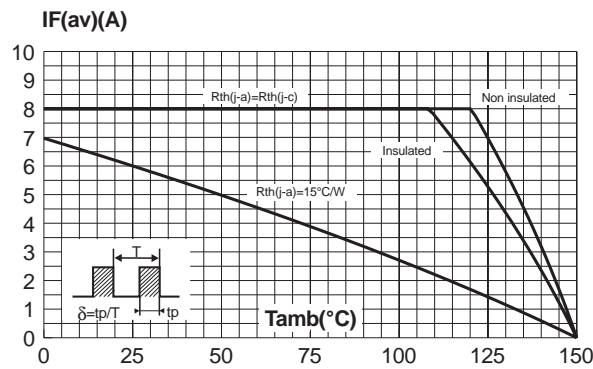

Fig. 4-1: Non repetitive surge peak forward current versus overload duration (TO-220AC).

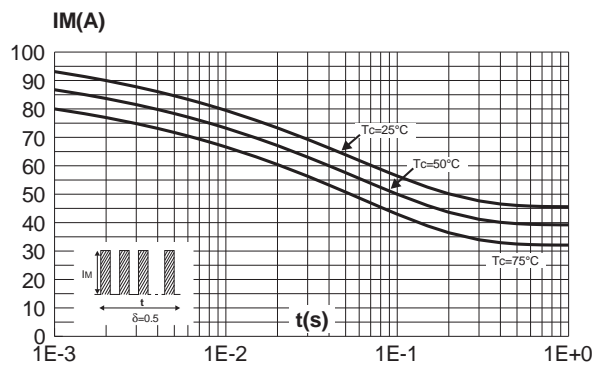

Fig. 4-2: Non repetitive surge peak forward current versus overload duration (insulated TO-220AC).

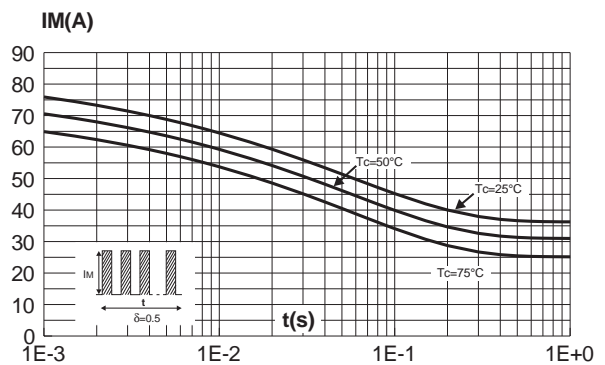

Fig. 5: Relative variation of thermal impedance junction to case versus pulse duration.

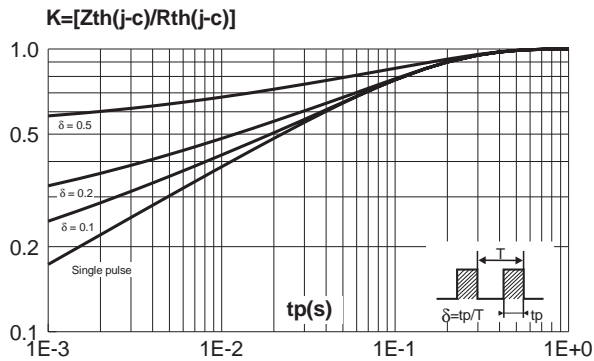

Fig. 7: Junction capacitance versus reverse voltage applied (typical values, per diode).

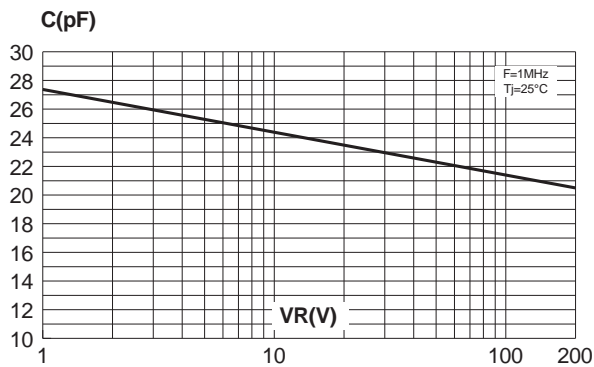

Fig. 9: Recovery current versus dI_F/dt (per diode).

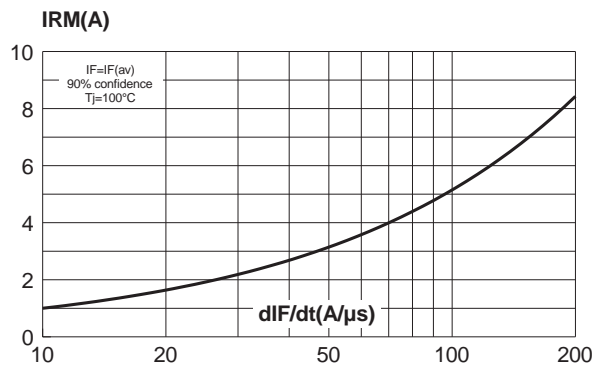

Fig. 6: Forward voltage drop versus forward current (maximum values, per diode).

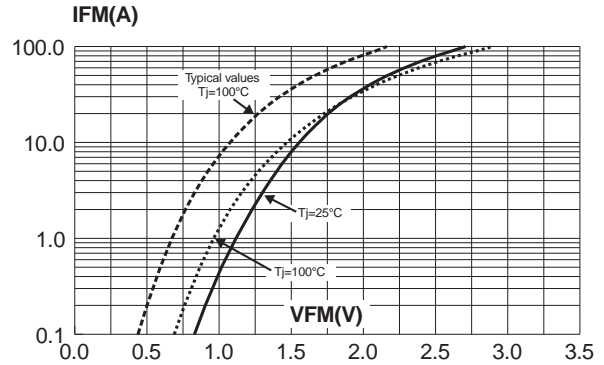

Fig. 8: Recovery charges versus dI_F/dt (per diode).

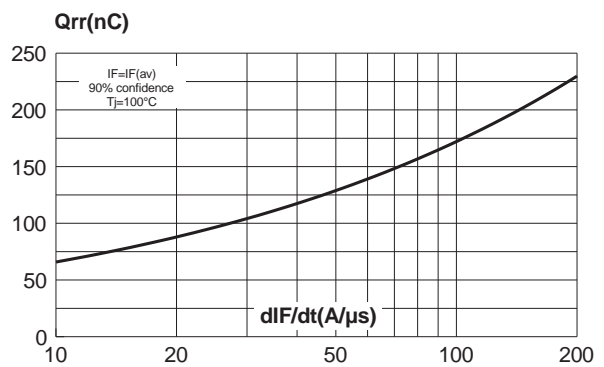

Fig. 10: Transient peak forward voltage versus dI_F/dt (per diode)

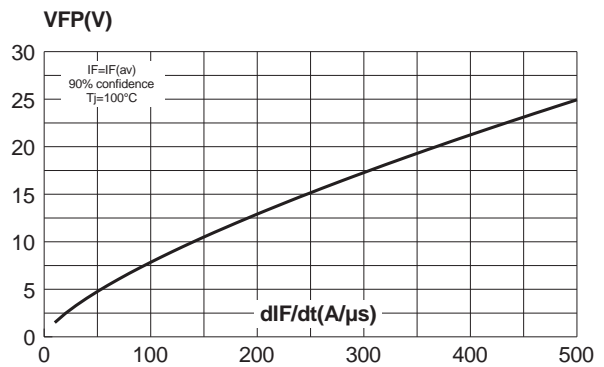

Fig. 11: Forward recovery time versus di_F/dt (per diode)

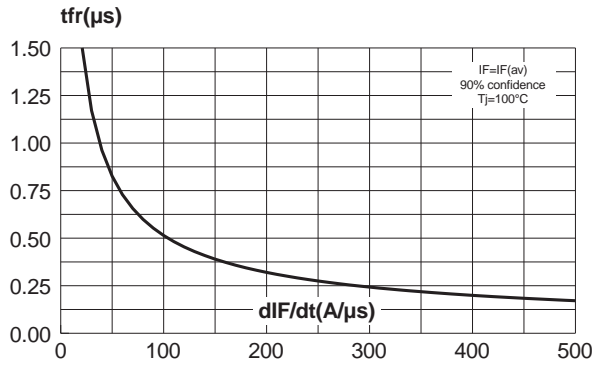

Fig. 12: Dynamic parameters versus junction temperature.

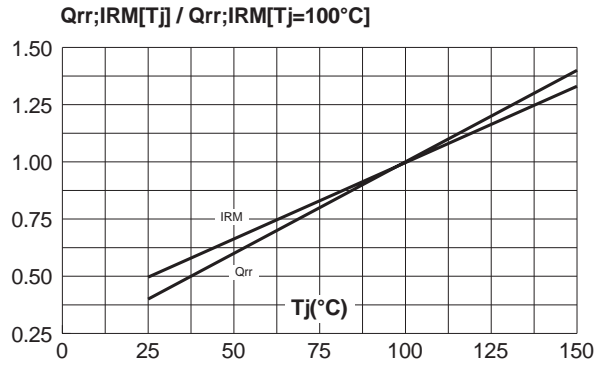

Fig. 13: Turn-off switching characteristics (without series inductance).

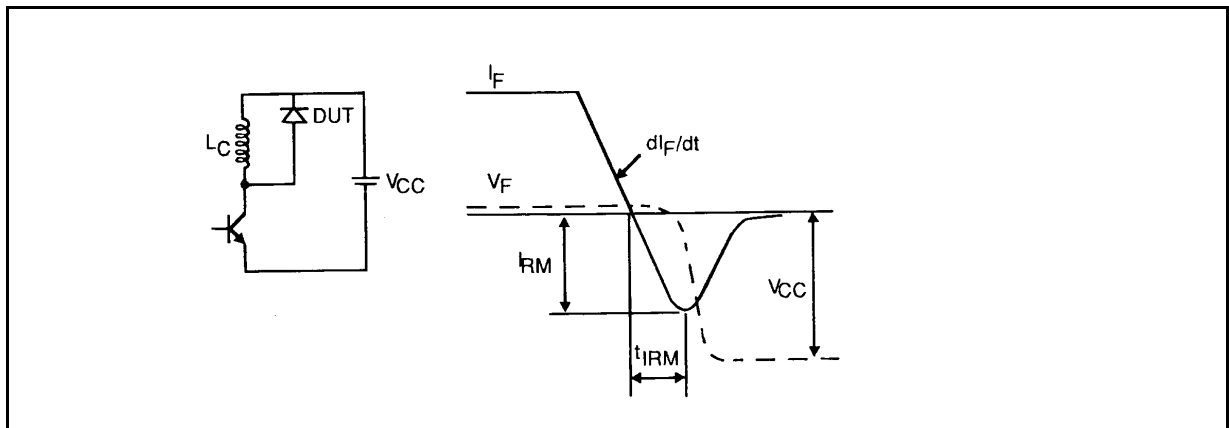
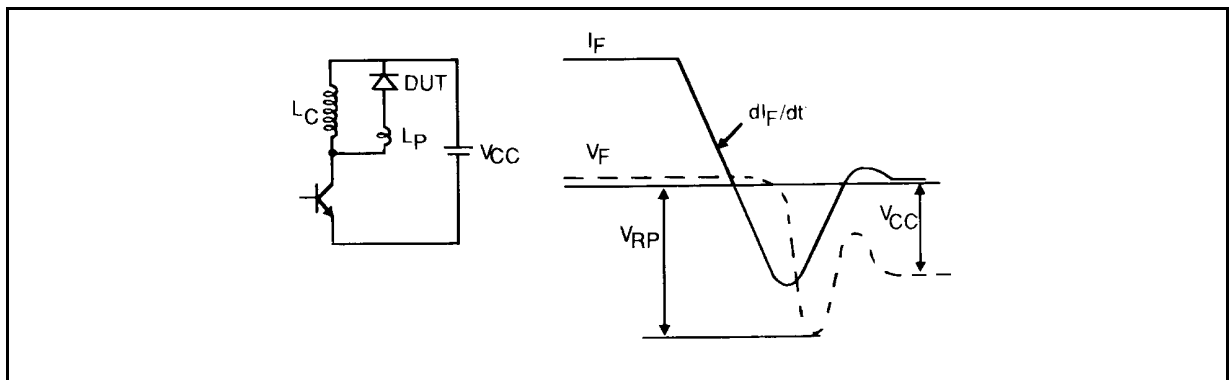
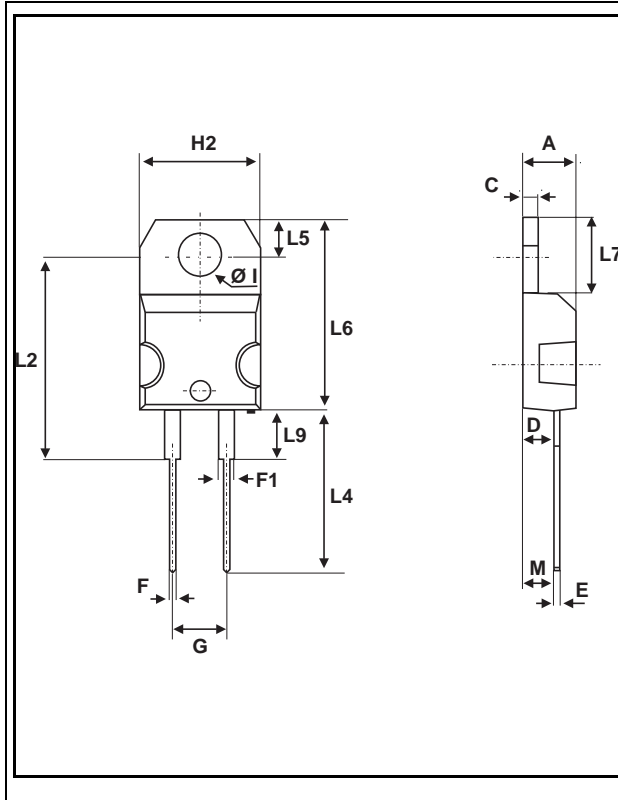

Fig. 14: Turn-off switching characteristics (with series inductance).



PACKAGE MECHANICAL DATA

TO-220AC



REF.	DIMENSIONS			
	Millimeters		Inches	
	Min.	Max.	Min.	Max.
A	4.40	4.60	0.173	0.181
C	1.23	1.32	0.048	0.051
D	2.40	2.72	0.094	0.107
E	0.49	0.70	0.019	0.027
F	0.61	0.88	0.024	0.034
F1	1.14	1.70	0.044	0.066
G	4.95	5.15	0.194	0.202
H2	10.00	10.40	0.393	0.409
L2	16.40 typ.		0.645 typ.	
L4	13.00	14.00	0.511	0.551
L5	2.65	2.95	0.104	0.116
L6	15.25	15.75	0.600	0.620
L7	6.20	6.60	0.244	0.259
L9	3.50	3.93	0.137	0.154
M	2.6 typ.		0.102 typ.	
Diam. I	3.75	3.85	0.147	0.151

PACKAGE MECHANICAL DATA
TO-220AC Insulated

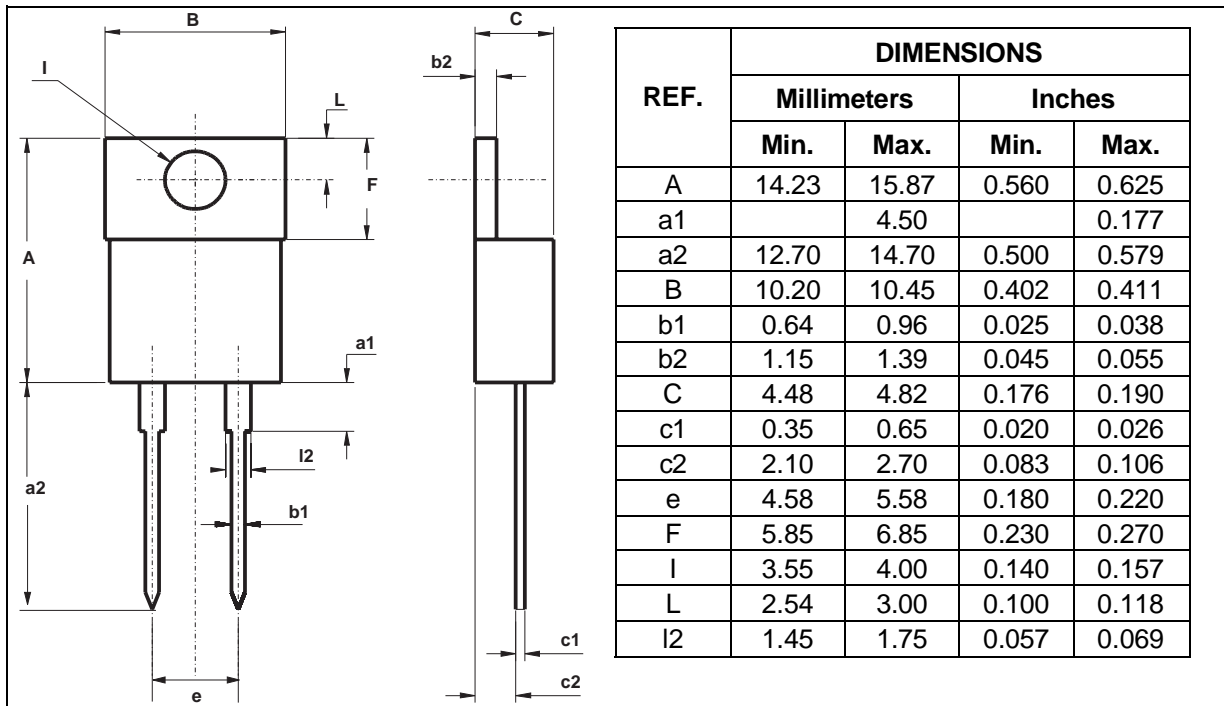

Ordering type	Marking	Package	Weight	Base qty	Delivery mode
BYT08P-400	BYT08P-400	TO-220AC	1.86 g.	50	Tube
BYT08PI-400	BYT08PI-400	Insulated TO-220AC	1.86 g.	50	Tube

- Cooling method: by conduction (C)
- Recommended torque value: 0.8 N.m.
- Maximum torque value: 1.0 N.m.
- Epoxy meets UL94,V0

Information furnished is believed to be accurate and reliable. However, STMicroelectronics assumes no responsibility for the consequences of use of such information nor for any infringement of patents or other rights of third parties which may result from its use. No license is granted by implication or otherwise under any patent or patent rights of STMicroelectronics. Specifications mentioned in this publication are subject to change without notice. This publication supersedes and replaces all information previously supplied. STMicroelectronics products are not authorized for use as critical components in life support devices or systems without express written approval of STMicroelectronics.

The ST logo is a registered trademark of STMicroelectronics

© 1999 STMicroelectronics - Printed in Italy - All rights reserved.

STMicroelectronics GROUP OF COMPANIES

Australia - Brazil - China - Finland - France - Germany - Hong Kong - India - Italy - Japan - Malaysia
Malta - Morocco - Singapore - Spain - Sweden - Switzerland - United Kingdom - U.S.A.

<http://www.st.com>

