



## PD55003L-E

RF power transistor, LdmoST plastic family  
N-channel enhancement-mode, lateral MOSFETs

### Features

- Excellent thermal stability
- Common source configuration
- $P_{OUT} = 3\text{ W}$  with 17dB gain@500 MHz/12.5 V
- New leadless plastic package
- ESD protection
- Supplied in tape and reel of 3 K units
- In compliance with 2002/95/EC european directive

### Description

The PD55003L-E is a common source N-channel, enhancement-mode lateral field-effect RF power transistor. It is designed for high gain, broadband commercial and industrial application. It operates at 12 V in common source mode at frequencies of up to 1 GHz. PD55003L-E boasts the excellent gain, linearity and reliability of STH1LV latest LD-MOS technology mounted in the innovative leadless SMD plastic package, PowerFLAT™.

PD55003L-E's superior linearity performances makes it an ideal solution for car mobile radio.

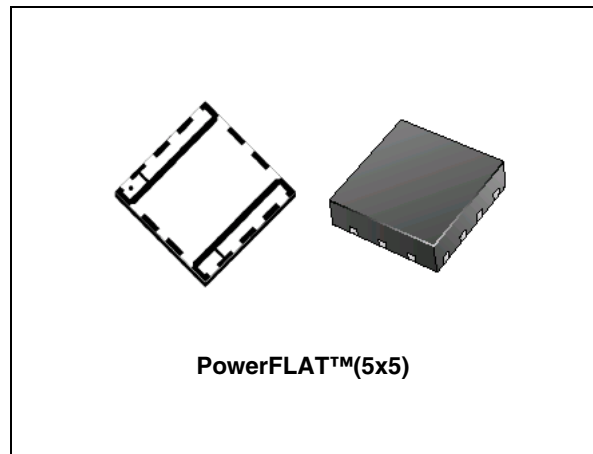

Figure 1. Pin configuration

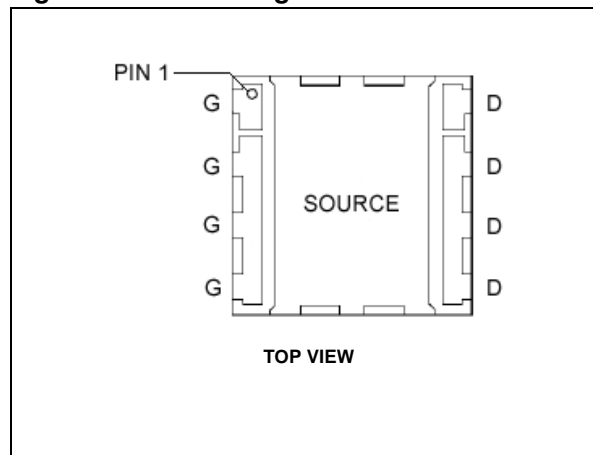

Table 1. Device summary

Order code	Marking	Package	Packaging
PD55003L-E	55003	PowerFLAT™(5x5)	Tape and reel

---

# Contents

<b>Contents</b> .....	<b>2</b>
<b>1 Maximum ratings</b> .....	<b>3</b>
<b>2 Electrical specification</b> .....	<b>4</b>
<b>3 Impedance</b> .....	<b>5</b>
3.1 Typical performances .....	6
3.2 Typical performance (broadband) .....	8
<b>4 Test circuit</b> .....	<b>9</b>
<b>5 Package mechanical data</b> .....	<b>14</b>
<b>6 Revision history</b> .....	<b>17</b>

# 1 Maximum ratings

( $T_{CASE}=25^{\circ}C$ )

**Table 2. Absolute maximum ratings ( $T_{CASE}=25^{\circ}C$ )**

Symbol	Parameter	Value	Unit
$V_{(BR)DSS}$	Drain-source voltage	40	V
$V_{GS}$	Gate-source voltage	-0.5 to +15	V
$I_D$	Drain current	2.5	A
$P_{DISS}$	Power dissipation (@ $T_C = 70^{\circ}C$ )	14	W
$T_{stg}$	Storage temperature	- 65 to +150	$^{\circ}C$
$T_j$	Operating junction temperature	150	$^{\circ}C$

**Table 3. Thermal data**

Symbol	Parameter	Value	Unit
$R_{th(j-c)}$	Junction-case thermal resistance	5.7	$^{\circ}C/W$

## 2 Electrical specification

( $T_{CASE}=25^{\circ}C$ )

**Table 4. Static**

Symbol	Test conditions	Min.	Typ.	Max.	Unit
$I_{DSS}$	$V_{GS}=0V, V_{DS}=28V$			1	$\mu A$
$I_{GSS}$	$V_{GS}=5V, V_{DS}=0V$			1	$\mu A$
$V_{GS(Q)}$	$V_{DS}=10V, I_D=50mA$	2.0		5.0	V
$V_{DS(ON)}$	$V_{GS}=10V, I_D=0.5A$			0.36	V
$g_{fs}$	$V_{DS}=10V, I_D=1A$		1.0		mho
$C_{iss}$ $C_{oss}$ $C_{rss}$	$V_{GS}=0V, V_{DS}=12.5V, f=1MHz$		34 23 1.8		pF pF pF

**Table 5. Dynamic**

Symbol	Test conditions	Min.	Typ.	Max.	Unit
$P_{1dB}$	$V_{DD}=12.5V, I_{DQ}=50mA, f=500MHz$	3			W
$G_P$	$V_{DD}=12.5V, I_{DQ}=50mA, P_{OUT}=3W, f=500MHz$	17	19		dB
$r_D$	$V_{DD}=12.5V, I_{DQ}=50mA, P_{OUT}=3W, f=500MHz$	50	52		%
Load mismatch	$V_{DD}=12.5V, I_{DQ}=50mA, P_{OUT}=3W, f=500MHz$	20:1			VSWR

**Table 6. ESD protection characteristics**

Test conditions	Class
Human body model	2
Machine model	M3

**Table 7. Moisture sensitivity level**

Test methodology	Rating
J-STD-020B	MSL 3

### 3 Impedance

Figure 2. Impedance data schematic

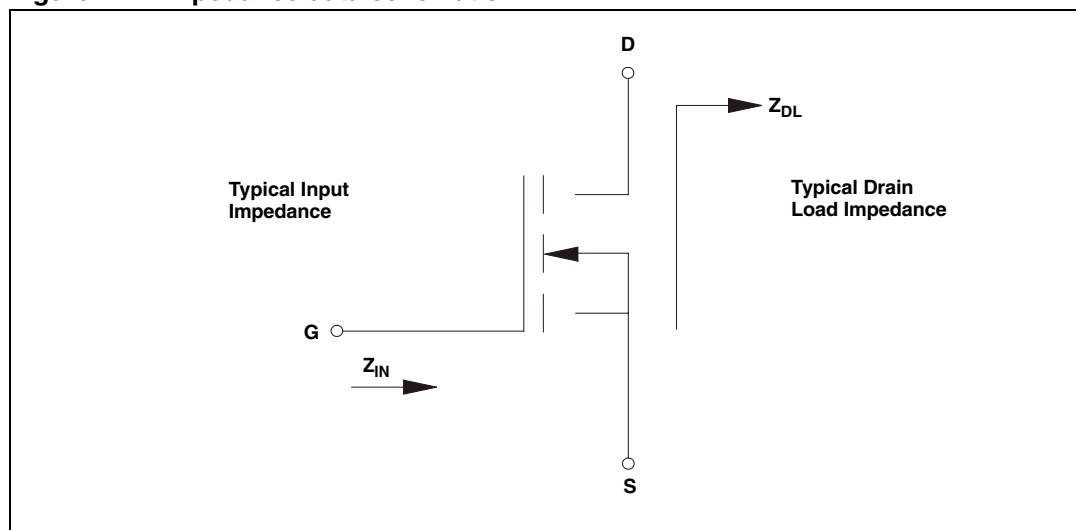

Table 8. Impedance data

Freq. MHz	$Z_{IN}(\Omega)$	$Z_{DL}(\Omega)$
480	1.79 - j 4.96	10.68 + j 7.45
500	1.88 - j 5.93	10.28 + j 8.92
520	2.10 - j 7.03	9.86 + j 10.18

### 3.1 Typical performances

Figure 3. Capacitance vs supply voltage

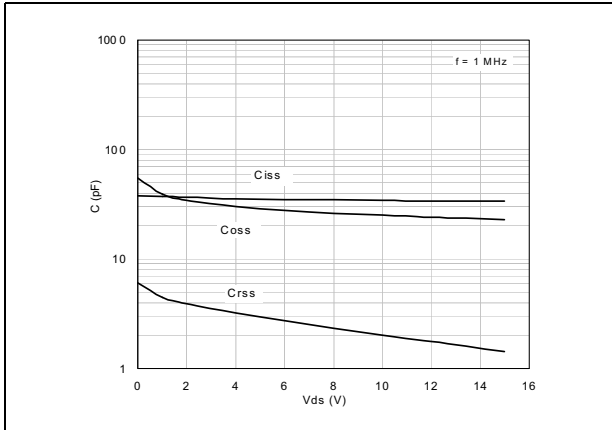

Figure 4. Output power vs input power

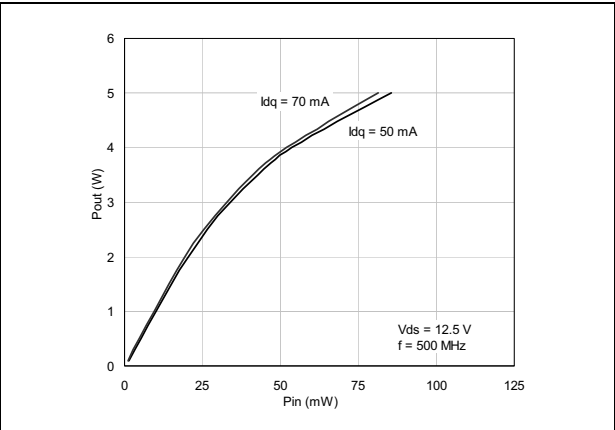

Figure 5. Power gain vs output power

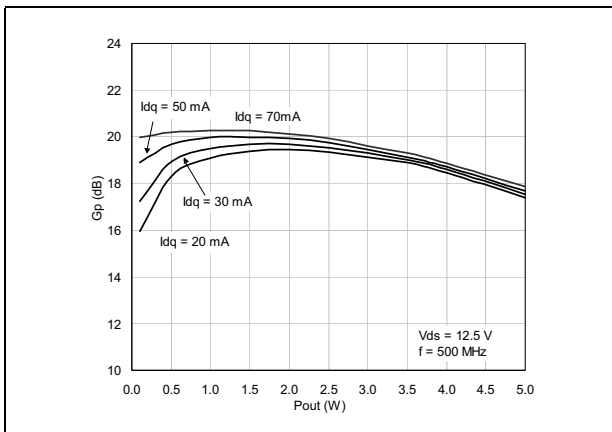

Figure 6. Efficiency vs output power

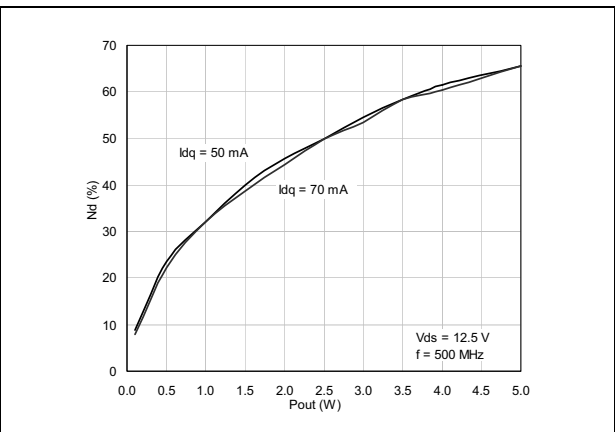

Figure 7. Input return loss vs output power

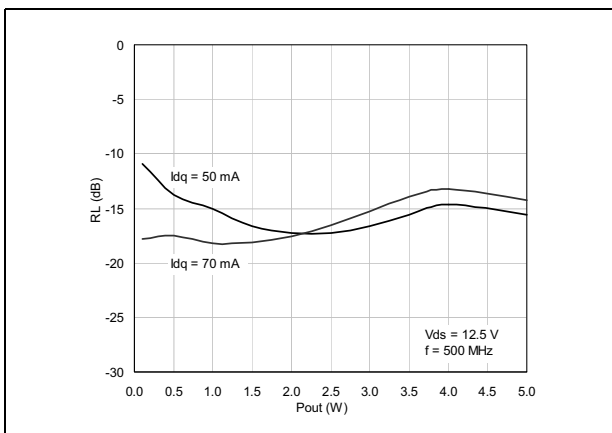

Figure 8. Output power vs bias current

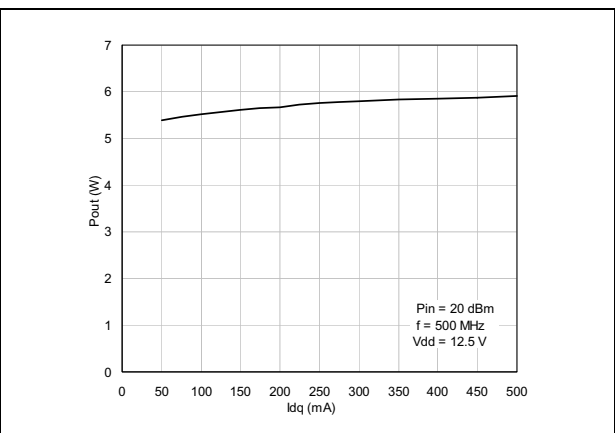

Figure 9. Efficiency vs bias current

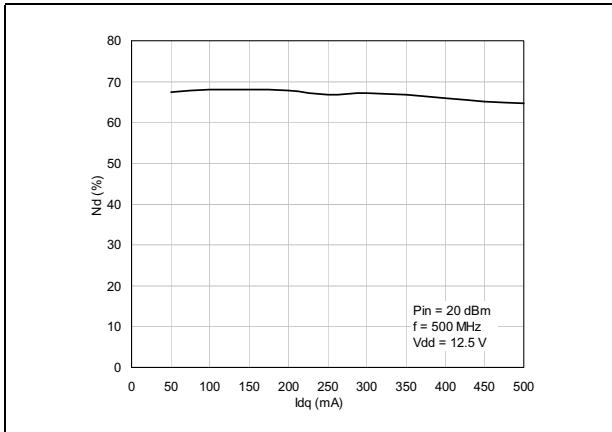

Figure 10. Output power vs supply voltage

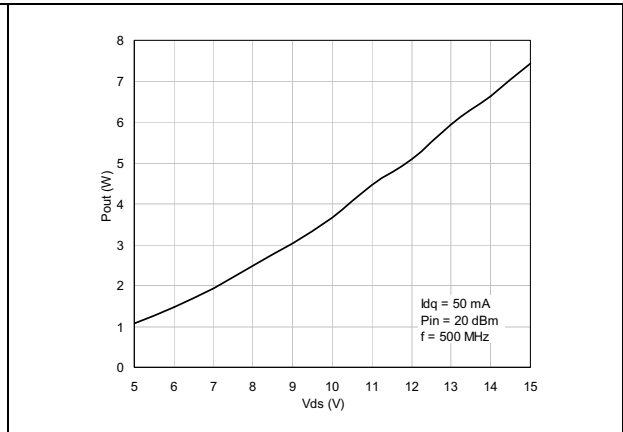
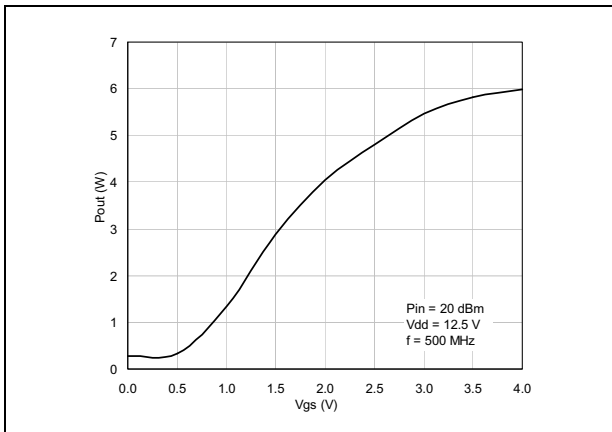

Figure 11. Output power vs gate-source voltage



### 3.2 Typical performance (broadband)

Figure 12. Power gain vs frequency

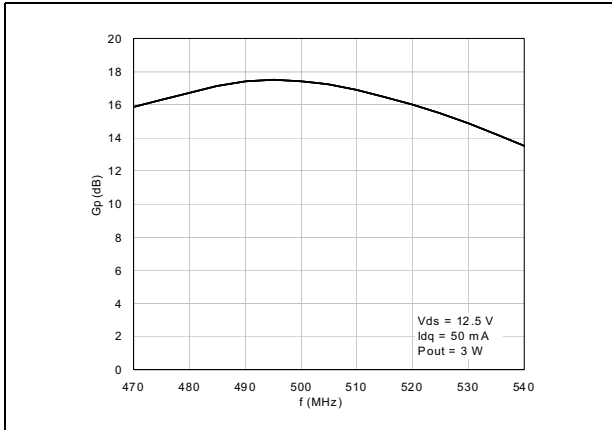

Figure 13. Efficiency vs frequency

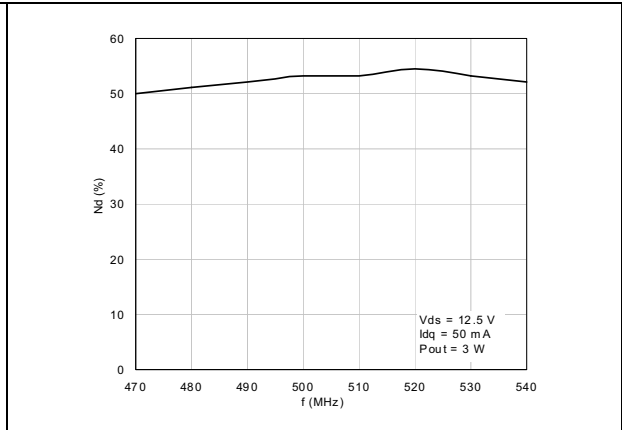
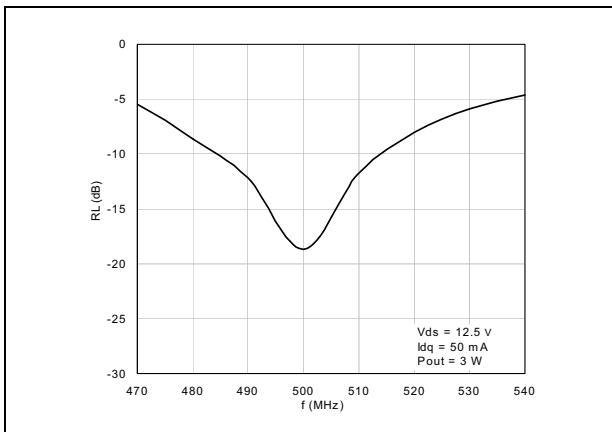

Figure 14. Return loss vs frequency





## 4 Test circuit

Figure 15. Test circuit schematic

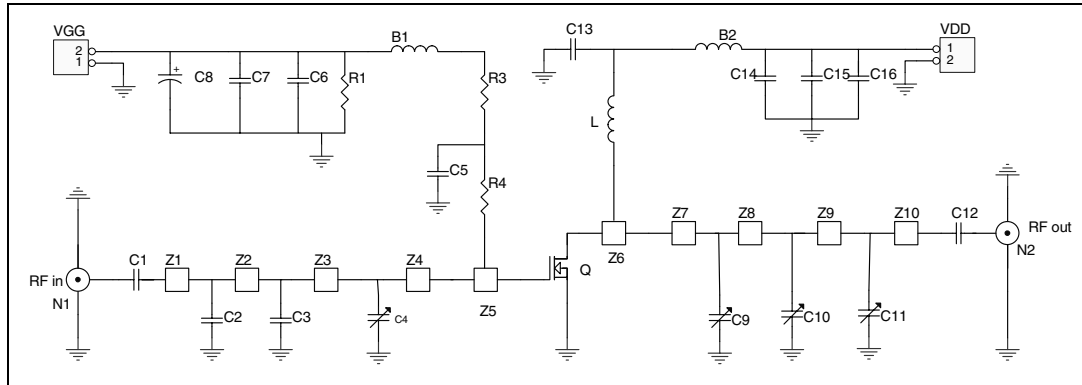

Table 9. Test circuit component list

Component	Description
B1, B2	Ferrite bead
C1, C12	3000 pF, 100B ATC chip capacitor
C2, C3	15 pF, 100B ATC chip capacitor
C4, C9	0 -:- 20 pF variable capacitor JOHANSON
C5, C13	120 pF 100B ACT chip capacitor
C6, C14	0.1 mF 100B ACT capacitor
C7, C15	1200 pF 100B ACT capacitor
C8, C16	10 μF, 35V, SMD electrolytic capacitor
C10	0.5 -:- 5 pF variable capacitor JOHANSON
C11	0.8 -:- 10 pF variable capacitor JOHANSON
R1	33 KΩ chip resistor 1 W
R2, R3	15 Ω melf resistor 1 W
R4	1 KΩ chip resistor 1 W
N1, N2	Type N flange mount
BOARD	ROGER ultra lam 2000 THK 0.030" $\epsilon_r = 2.55$ 2OZ ED Cu both sides

Figure 16. Test circuit

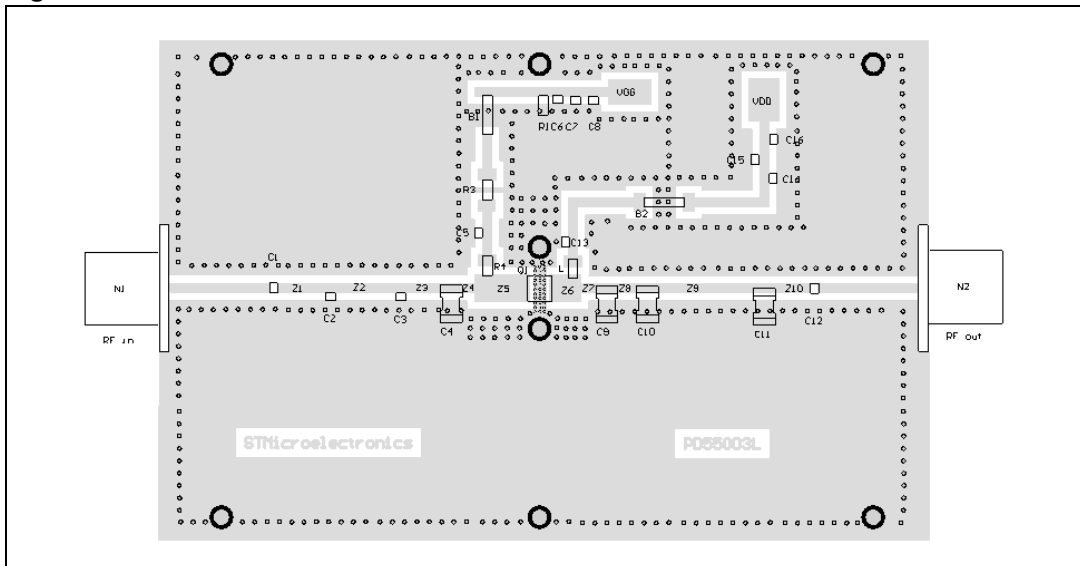

Figure 17. Test circuit photomaster

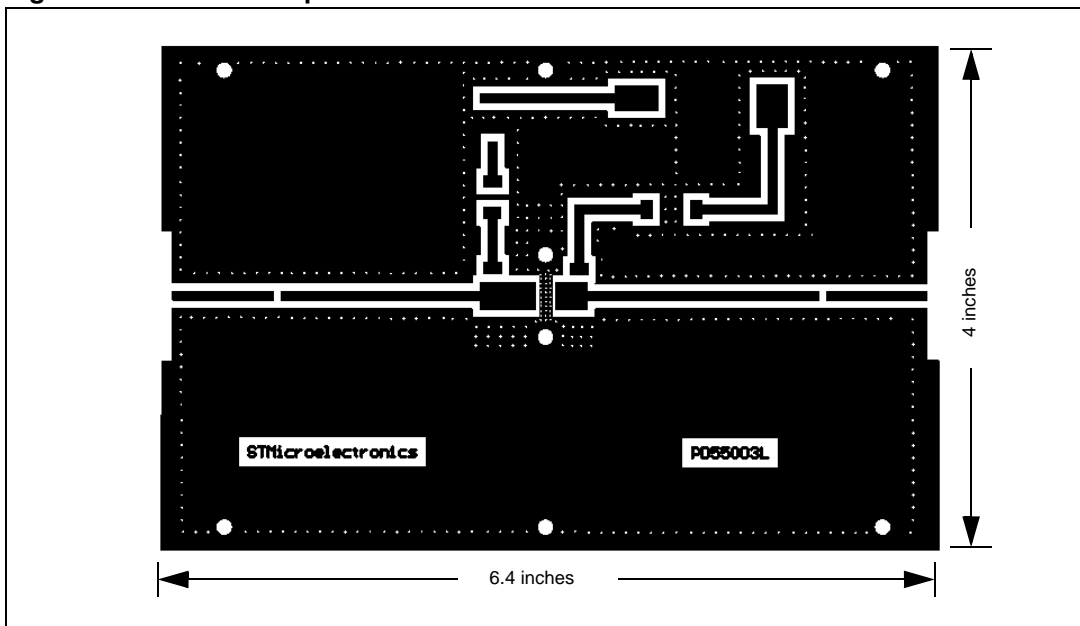

Table 10. S-Parameter (PD55003L-E) @  $V_{DS}=12.5\text{ V}$ ,  $I_{DS}=0.15\text{ A}$

Freq. (MHz)	$ S_{11} $	$\angle S_{11}$	$ S_{21} $	$\angle S_{21}$	$ S_{12} $	$\angle S_{12}$	$ S_{22} $	$\angle S_{22}$
50	0.808	-110	20.14	112	0.039	22	0.672	-109
100	0.772	-141	11.77	93	0.042	5	0.633	-138
150	0.771	-152	7.86	82	0.041	-5	0.642	-147
200	0.779	-157	5.80	73	0.040	-11	0.665	-151
250	0.794	-161	4.50	66	0.038	-17	0.694	-154
300	0.809	-163	3.62	60	0.035	-22	0.721	-155
350	0.824	-165	2.98	54	0.033	-26	0.750	-157
400	0.839	-166	2.50	49	0.031	-30	0.774	-159
450	0.853	-168	2.13	44	0.028	-32	0.796	-160
500	0.865	-169	1.83	40	0.025	-34	0.818	-161
550	0.874	-171	1.59	36	0.023	-36	0.837	-163
600	0.885	-172	1.39	33	0.021	-36	0.852	-164
650	0.894	-173	1.23	29	0.018	-37	0.867	-165
700	0.901	-174	1.10	26	0.016	-37	0.880	-166
750	0.906	-175	0.97	23	0.015	-36	0.890	-167
800	0.911	-176	0.88	20	0.012	-32	0.902	-169
850	0.916	-177	0.79	18	0.011	-28	0.909	-169
900	0.918	-178	0.72	15	0.010	-22	0.918	-171
950	0.922	-179	0.65	13	0.008	-13	0.922	-171
1000	0.925	180	0.59	11	0.007	-7	0.928	-172
1050	0.925	179	0.54	9	0.007	8	0.934	-173
1100	0.928	178	0.50	7	0.006	21	0.938	-174
1150	0.927	177	0.46	5	0.007	38	0.941	-175
1200	0.928	176	0.43	4	0.008	51	0.944	-176
1250	0.929	175	0.40	2	0.010	56	0.947	-176
1300	0.927	175	0.37	1	0.011	61	0.953	-177
1350	0.927	174	0.34	-1	0.011	65	0.951	-178
1400	0.925	173	0.32	-2	0.012	68	0.952	-178
1450	0.922	172	0.30	-4	0.014	72	0.954	-179
1500	0.922	172	0.28	-5	0.016	73	0.957	-180

Table 11. S-Parameter (PD55003L-E) @  $V_{DS}=12.5\text{ V}$ ,  $I_{DS}=0.8\text{ A}$ 

Freq. (MHz)	$ S_{11} $	$\angle S_{11}$	$ S_{21} $	$\angle S_{21}$	$ S_{12} $	$\angle S_{12}$	$ S_{22} $	$\angle S_{22}$
50	0.841	-124	22.20	107	0.029	21	0.651	-130
100	0.800	-150	12.84	92	0.031	6	0.654	-153
150	0.800	-159	8.59	83	0.031	-2	0.666	-159
200	0.803	-163	6.38	76	0.030	-8	0.684	-161
250	0.812	-166	5.00	70	0.028	-11	0.702	-163
300	0.822	-168	4.07	64	0.027	-15	0.721	-163
350	0.830	-169	3.39	59	0.025	-17	0.740	-164
400	0.837	-170	2.87	55	0.024	-20	0.760	-165
450	0.848	-172	2.47	50	0.022	-23	0.777	-166
500	0.857	-172	2.15	46	0.020	-23	0.795	-166
550	0.866	-174	1.89	42	0.018	-25	0.813	-167
600	0.874	-174	1.67	39	0.017	-23	0.825	-168
650	0.882	-175	1.49	35	0.015	-24	0.839	-168
700	0.887	-176	1.33	32	0.013	-22	0.853	-169
750	0.893	-177	1.19	29	0.012	-16	0.863	-170
800	0.898	-178	1.08	26	0.011	-15	0.875	-171
850	0.903	-179	0.98	23	0.010	-11	0.885	-172
900	0.904	-180	0.89	21	0.009	-1	0.893	-173
950	0.909	179	0.82	19	0.008	7	0.901	-173
1000	0.911	179	0.75	16	0.008	16	0.904	-174
1050	0.914	178	0.69	14	0.008	27	0.911	-175
1100	0.916	177	0.64	12	0.008	35	0.916	-175
1150	0.917	176	0.59	10	0.009	43	0.919	-176
1200	0.917	176	0.55	8	0.010	48	0.923	-177
1250	0.918	175	0.51	6	0.010	57	0.929	-177
1300	0.917	174	0.47	5	0.012	62	0.929	-178
1350	0.917	173	0.44	3	0.013	63	0.934	-179
1400	0.914	173	0.42	1	0.013	67	0.936	-179
1450	0.912	172	0.39	0	0.015	71	0.938	-180
1500	0.911	171	0.36	-2	0.016	72	0.941	179

Table 12. S-Parameter (PD55003L-E) @  $V_{DS}=12.5\text{ V}$ ,  $I_{DS}=1.5\text{ A}$

Freq. (MHz)	$ S_{11} $	$S_{11} < \Phi$	$ S_{21} $	$S_{21} < \Phi$	$ S_{12} $	$S_{12} < \Phi$	$ S_{22} $	$S_{22} < \Phi$
50	0.837	-114	18.43	111	0.030	24	0.588	-132
100	0.799	-143	10.49	93	0.033	6	0.632	-152
150	0.801	-154	6.99	82	0.032	-3	0.656	-158
200	0.809	-159	5.15	74	0.031	-9	0.680	-160
250	0.823	-163	4.00	67	0.029	-14	0.701	-162
300	0.835	-165	3.22	61	0.028	-18	0.726	-163
350	0.845	-167	2.66	56	0.025	-20	0.750	-164
400	0.855	-169	2.23	52	0.024	-24	0.768	-165
450	0.866	-170	1.91	47	0.022	-26	0.789	-166
500	0.876	-171	1.65	43	0.020	-24	0.812	-167
550	0.882	-173	1.44	39	0.018	-25	0.828	-167
600	0.892	-174	1.26	36	0.016	-25	0.836	-168
650	0.898	-175	1.12	33	0.015	-25	0.844	-169
700	0.903	-176	1.00	29	0.013	-20	0.857	-170
750	0.907	-177	0.90	27	0.011	-17	0.868	-171
800	0.909	-178	0.81	24	0.010	-10	0.883	-171
850	0.912	-179	0.73	21	0.009	-6	0.889	-172
900	0.915	-180	0.67	19	0.009	1	0.894	-173
950	0.917	179	0.61	17	0.008	17	0.905	-174
1000	0.917	178	0.56	15	0.008	24	0.907	-174
1050	0.918	178	0.51	13	0.008	32	0.908	-175
1100	0.920	177	0.47	11	0.009	40	0.912	-176
1150	0.920	176	0.44	9	0.010	48	0.919	-177
1200	0.920	175	0.41	7	0.010	57	0.922	-177
1250	0.919	174	0.38	6	0.012	59	0.926	-178
1300	0.919	174	0.35	4	0.013	61	0.931	-179
1350	0.918	173	0.33	3	0.014	63	0.928	-179
1400	0.917	172	0.31	1	0.015	68	0.929	-180
1450	0.914	172	0.29	0	0.016	70	0.933	180
1500	0.912	171	0.27	-1	0.018	71	0.935	179

## 5 Package mechanical data

In order to meet environmental requirements, ST offers these devices in different grades of ECOPACK® packages, depending on their level of environmental compliance. ECOPACK® specifications, grade definitions and product status are available at: [www.st.com](http://www.st.com). ECOPACK is an ST trademark.

Table 13. PowerFLAT™ mechanical data

Dim.	mm			inch		
	Min.	Typ.	Max.	Min.	Typ.	Max.
A		0.90	1.00		0.035	0.039
A1		0.02	0.05		0.001	0.002
A3		0.24			0.009	
AA	0.15	0.25	0.35	0.006	0.01	0.014
b	0.43	0.51	0.58	0.017	0.020	0.023
c	0.64	0.71	0.79	0.025	0.028	0.031
D		5.00			0.197	
d		0.30			0.011	
E		5.00			0.197	
E2	2.49	2.57	2.64	0.098	0.101	0.104
e		1.27			0.050	
f		3.37			0.132	
g		0.74			0.03	
h		0.21			0.008	

Figure 18. PowerFLAT™ package dimensions

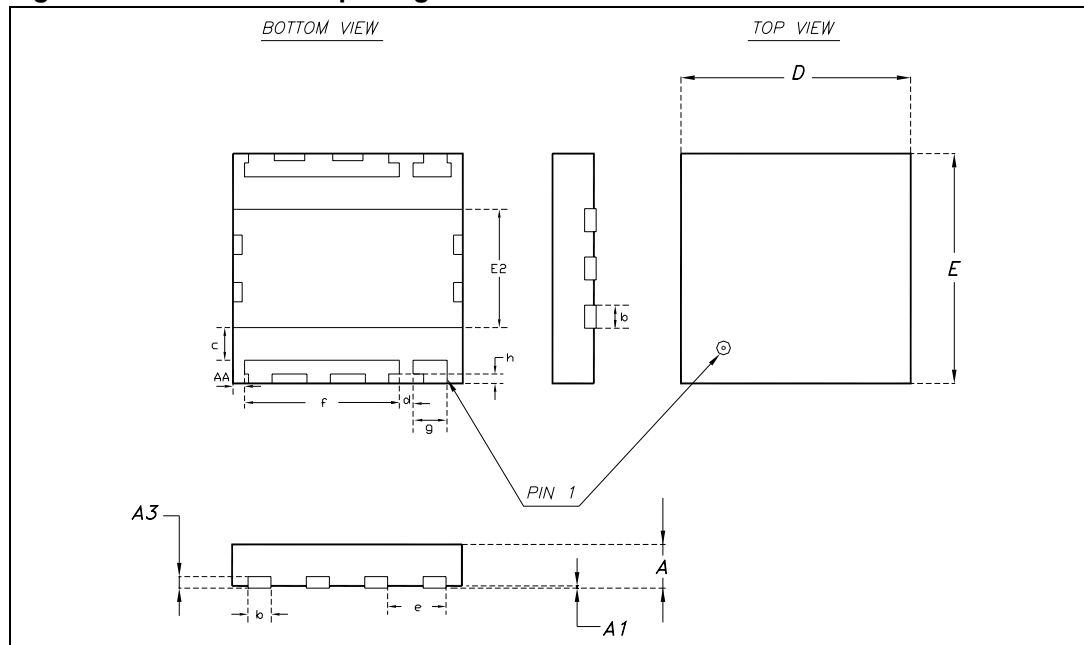

**Table 14. PowerFLAT™ tape and reel dimensions**

DIM.	mm.		
	Min.	Typ	Max.
Ao	5.15	5.25	5.35
Bo	5.15	5.25	5.35
Ko	1.0	1.1	1.2

**Figure 19. PowerFLAT™ tape and reel**

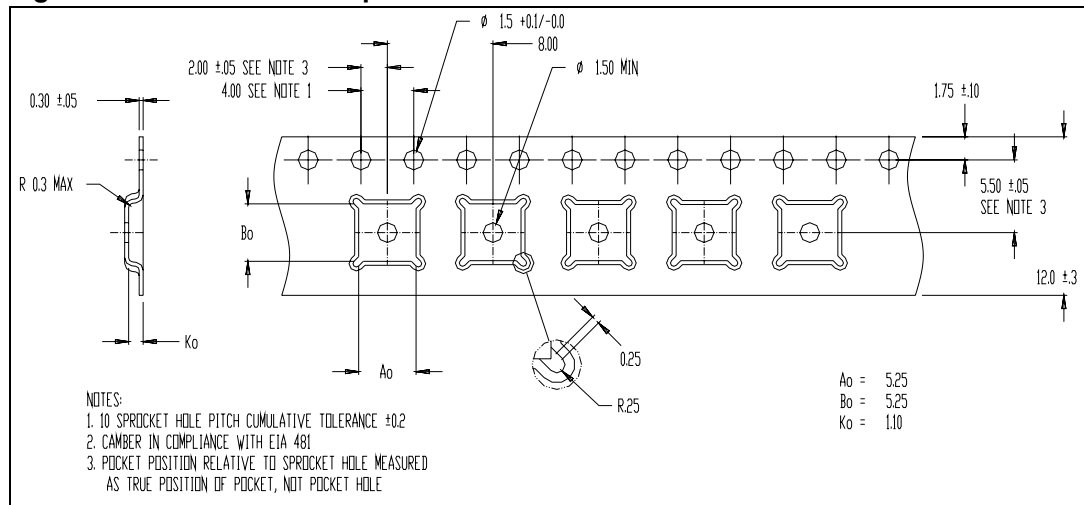

**Figure 20. Recommended footprint**

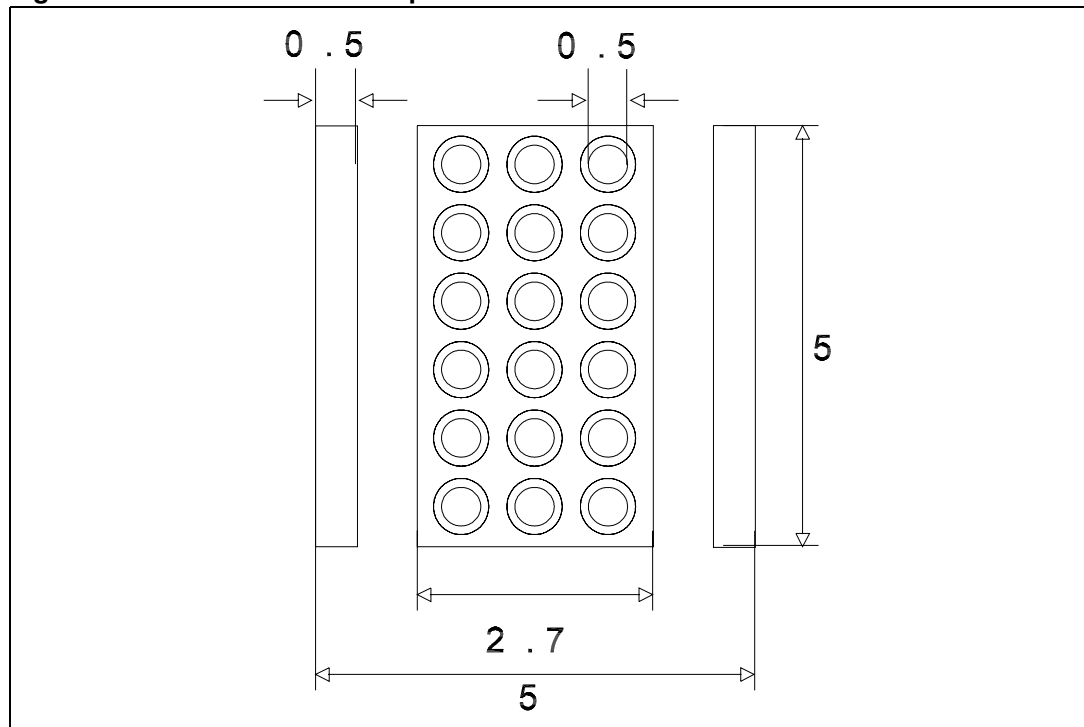



## 6 Revision history

**Table 15. Document revision history**

Date	Revision	Changes
14-Feb-2006	1	First Issue.
29-Apr-2011	2	Updated <a href="#">Table 4</a> .

**Please Read Carefully:**

Information in this document is provided solely in connection with ST products. STMicroelectronics NV and its subsidiaries ("ST") reserve the right to make changes, corrections, modifications or improvements, to this document, and the products and services described herein at any time, without notice.

All ST products are sold pursuant to ST's terms and conditions of sale.

Purchasers are solely responsible for the choice, selection and use of the ST products and services described herein, and ST assumes no liability whatsoever relating to the choice, selection or use of the ST products and services described herein.

No license, express or implied, by estoppel or otherwise, to any intellectual property rights is granted under this document. If any part of this document refers to any third party products or services it shall not be deemed a license grant by ST for the use of such third party products or services, or any intellectual property contained therein or considered as a warranty covering the use in any manner whatsoever of such third party products or services or any intellectual property contained therein.

**UNLESS OTHERWISE SET FORTH IN ST'S TERMS AND CONDITIONS OF SALE ST DISCLAIMS ANY EXPRESS OR IMPLIED WARRANTY WITH RESPECT TO THE USE AND/OR SALE OF ST PRODUCTS INCLUDING WITHOUT LIMITATION IMPLIED WARRANTIES OF MERCHANTABILITY, FITNESS FOR A PARTICULAR PURPOSE (AND THEIR EQUIVALENTS UNDER THE LAWS OF ANY JURISDICTION), OR INFRINGEMENT OF ANY PATENT, COPYRIGHT OR OTHER INTELLECTUAL PROPERTY RIGHT.**

**UNLESS EXPRESSLY APPROVED IN WRITING BY AN AUTHORIZED ST REPRESENTATIVE, ST PRODUCTS ARE NOT RECOMMENDED, AUTHORIZED OR WARRANTED FOR USE IN MILITARY, AIR CRAFT, SPACE, LIFE SAVING, OR LIFE SUSTAINING APPLICATIONS, NOR IN PRODUCTS OR SYSTEMS WHERE FAILURE OR MALFUNCTION MAY RESULT IN PERSONAL INJURY, DEATH, OR SEVERE PROPERTY OR ENVIRONMENTAL DAMAGE. ST PRODUCTS WHICH ARE NOT SPECIFIED AS "AUTOMOTIVE GRADE" MAY ONLY BE USED IN AUTOMOTIVE APPLICATIONS AT USER'S OWN RISK.**

Resale of ST products with provisions different from the statements and/or technical features set forth in this document shall immediately void any warranty granted by ST for the ST product or service described herein and shall not create or extend in any manner whatsoever, any liability of ST.

ST and the ST logo are trademarks or registered trademarks of ST in various countries.

Information in this document supersedes and replaces all information previously supplied.

The ST logo is a registered trademark of STMicroelectronics. All other names are the property of their respective owners.

© 2011 STMicroelectronics - All rights reserved

STMicroelectronics group of companies

Australia - Belgium - Brazil - Canada - China - Czech Republic - Finland - France - Germany - Hong Kong - India - Israel - Italy - Japan - Malaysia - Malta - Morocco - Philippines - Singapore - Spain - Sweden - Switzerland - United Kingdom - United States of America

[www.st.com](http://www.st.com)