

200-MHz GENERAL-PURPOSE CLOCK BUFFER, PCI-X COMPLIANT

Check for Samples: [CDCV304-EP](#)

FEATURES

- General-Purpose and PCI-X 1:4 Clock Buffer
- Operating Frequency
 - 0 MHz to 200 MHz General-Purpose
- Low Output Skew: <100 ps
- Distributes One Clock Input to One Bank of Four Outputs
- Output Enable Control that Drives Outputs Low when OE is Low
- Operates from Single 3.3-V Supply or 2.5-V Supply
- PCI-X Compliant
- 8-Pin TSSOP Package

SUPPORTS DEFENSE, AEROSPACE, AND MEDICAL APPLICATIONS

- Controlled Baseline
- One Assembly/Test Site
- One Fabrication Site
- Available in –40°C/105°C Temperature Range⁽¹⁾
- Extended Product Life Cycle
- Extended Product-Change Notification
- Product Traceability

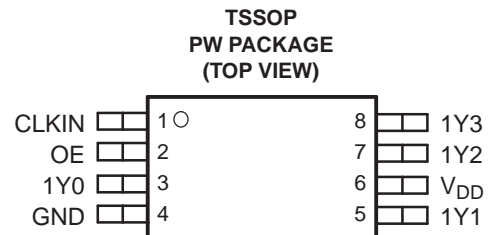

(1) Custom temperature ranges available

DESCRIPTION

The CDCV304 is a high-performance, low-skew, general-purpose PCI-X compliant clock buffer. It distributes one input clock signal (CLKIN) to the output clocks (1Y[0:3]). It is specifically designed for use with PCI-X applications. The CDCV304 operates at 3.3 V and 2.5 V and is therefore compliant to the 3.3-V PCI-X specifications.

The CDCV304 is characterized for operation from –40°C to 105°C.

FUNCTIONAL BLOCK DIAGRAM

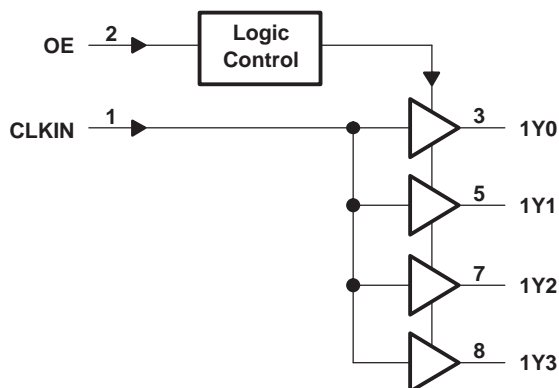
Table 1. FUNCTION TABLE

INPUTS		OUTPUTS
CLKIN	OE	1Y[0:3]
L	L	L
H	L	L
L	H	L
H	H	H



Please be aware that an important notice concerning availability, standard warranty, and use in critical applications of Texas Instruments semiconductor products and disclaimers thereto appears at the end of this data sheet.



This integrated circuit can be damaged by ESD. Texas Instruments recommends that all integrated circuits be handled with appropriate precautions. Failure to observe proper handling and installation procedures can cause damage.

ESD damage can range from subtle performance degradation to complete device failure. Precision integrated circuits may be more susceptible to damage because very small parametric changes could cause the device not to meet its published specifications.

Table 2. ORDERING INFORMATION⁽¹⁾

T _A	PACKAGE	ORDERABLE PART NUMBER	TOP-SIDE MARKING	VID NUMBER
–40°C to 105°C	TSSOP - PW	CDCV304TPWREP	C304T	V62/12618-01XE

(1) For the most current package and ordering information, see the Package Option Addendum at the end of this document, or see the TI Web site at www.ti.com.

TERMINAL FUNCTIONS

TERMINAL		I/O	DESCRIPTION
NAME	NO.		
1Y[0:3]	3, 5, 7, 8	O	Buffered output clocks
CLKIN	1	I	Input reference frequency
GND	4	Power	Ground
OE	2	I	Output enable control
V _{DD}	6	Power	Supply

ABSOLUTE MAXIMUM RATINGS

over operating free-air temperature range (unless otherwise noted) ⁽¹⁾

	UNIT
Supply voltage range, V _{DD}	–0.5 V to 4.3 V
Input voltage range, V _I ⁽²⁾ ⁽³⁾	–0.5 V to V _{DD} + 0.5 V
Output voltage range, V _O ⁽²⁾ ⁽³⁾	–0.5 V to V _{DD} + 0.5 V
Input clamp current, I _{IK} (V _I < 0 or V _I > V _{DD})	±50 mA
Output clamp current, I _{OK} (V _O < 0 or V _O > V _{DD})	±50 mA
Continuous total output current, I _O (V _O = 0 to V _{DD})	±50 mA
Storage temperature range T _{stg}	–65°C to 150°C

- (1) Stresses beyond those listed under “absolute maximum ratings” may cause permanent damage to the device. These are stress ratings only, and functional operation of the device at these or any other conditions beyond those indicated under “recommended operating conditions” is not implied. Exposure to absolute-maximum-rated conditions for extended periods may affect device reliability.
- (2) The input and output negative voltage ratings may be exceeded if the input and output clamp-current ratings are observed.
- (3) This value is limited to 4.6 V maximum.

THERMAL INFORMATION

THERMAL METRIC ⁽¹⁾		CDCV304		UNITS
		PW		
		8 PINS		
θ_{JA}	Junction-to-ambient thermal resistance ⁽²⁾	175.8		°C/W
θ_{JCTop}	Junction-to-case (top) thermal resistance ⁽³⁾	61.8		
θ_{JB}	Junction-to-board thermal resistance ⁽⁴⁾	104.3		
ψ_{JT}	Junction-to-top characterization parameter ⁽⁵⁾	7.7		
ψ_{JB}	Junction-to-board characterization parameter ⁽⁶⁾	102.6		

- (1) For more information about traditional and new thermal metrics, see the *IC Package Thermal Metrics* application report, [SPRA953](#).
- (2) The junction-to-ambient thermal resistance under natural convection is obtained in a simulation on a JEDEC-standard, high-K board, as specified in JESD51-7, in an environment described in JESD51-2a.
- (3) The junction-to-case (top) thermal resistance is obtained by simulating a cold plate test on the package top. No specific JEDEC-standard test exists, but a close description can be found in the ANSI SEMI standard G30-88.
- (4) The junction-to-board thermal resistance is obtained by simulating in an environment with a ring cold plate fixture to control the PCB temperature, as described in JESD51-8.
- (5) The junction-to-top characterization parameter, ψ_{JT} , estimates the junction temperature of a device in a real system and is extracted from the simulation data for obtaining θ_{JA} , using a procedure described in JESD51-2a (sections 6 and 7).
- (6) The junction-to-board characterization parameter, ψ_{JB} , estimates the junction temperature of a device in a real system and is extracted from the simulation data for obtaining θ_{JA} , using a procedure described in JESD51-2a (sections 6 and 7).

RECOMMENDED OPERATING CONDITIONS

		MIN	NOM	MAX	UNIT
Supply voltage, V_{DD}		2.3		3.6	V
Low-level input voltage, V_{IL}				$0.3 \times V_{DD}$	V
High-level input voltage, V_{IH}		$0.7 \times V_{DD}$			V
Input voltage, V_I		0		V_{DD}	V
High-level output current, I_{OH}	$V_{DD} = 2.5\text{ V}$			-12	mA
	$V_{DD} = 3.3\text{ V}$			-24	
Low-level output current, I_{OL}	$V_{DD} = 2.5\text{ V}$			12	mA
	$V_{DD} = 3.3\text{ V}$			24	
Operating free-air temperature, T_A		-40		105	°C

TIMING REQUIREMENTS

over operating free-air temperature range (unless otherwise noted)

PARAMETER		TEST CONDITIONS	MIN	TYP	MAX	UNIT
f_{clk}	Clock frequency		0		200	MHz

ELECTRICAL CHARACTERISTICS

over recommended operating free-air temperature range (unless otherwise noted)

PARAMETER		TEST CONDITIONS		MIN	TYP ⁽¹⁾	MAX	UNIT
V_{IK}	Input voltage	$V_{DD} = 3\text{ V}$,	$I_I = -18\text{ mA}$			-1.2	V
V_{OH}	High-level output voltage	$V_{DD} = \text{min to max}$,	$I_{OH} = -1\text{ mA}$	$V_{DD} - 0.3$			V
		$V_{DD} = 2.3\text{ V}$,	$I_{OH} = -8\text{ mA}$	1.78			
		$V_{DD} = 3\text{ V}$,	$I_{OH} = -24\text{ mA}$	1.90			
		$V_{DD} = 3\text{ V}$,	$I_{OH} = -12\text{ mA}$	2.30			
V_{OL}	Low-level output voltage	$V_{DD} = 2.3\text{ V}$,	$I_{OL} = 8\text{ mA}$			0.51	V
		$V_{DD} = \text{min to max}$,	$I_{OL} = 1\text{ mA}$			0.20	
		$V_{DD} = 3\text{ V}$,	$I_{OL} = 24\text{ mA}$			0.84	
		$V_{DD} = 3\text{ V}$,	$I_{OL} = 12\text{ mA}$			0.60	
I_{OH}	High-level output current	$V_{DD} = 3\text{ V}$,	$V_O = 1\text{ V}$	-45			mA
		$V_{DD} = 3.3\text{ V}$,	$V_O = 1.65\text{ V}$			-55	
I_{OL}	Low-level output current	$V_{DD} = 3\text{ V}$,	$V_O = 2\text{ V}$	54			mA
		$V_{DD} = 3.3\text{ V}$,	$V_O = 1.65\text{ V}$			70	
I_I	Input current	$V_I = V_O \text{ or } V_{DD}$				± 5	μA
I_{DD}	Dynamic current, see	$f = 67\text{ MHz}$,	$V_{DD} = 2.7\text{ V}$			28	mA
		$f = 67\text{ MHz}$,	$V_{DD} = 3.6\text{ V}$			37	
C_I	Input capacitance	$V_{DD} = 3.3\text{ V}$,	$V_I = 0\text{ V or } V_{DD}$		3		pF
C_O	Output capacitance	$V_{DD} = 3.3\text{ V}$,	$V_I = 0\text{ V or } V_{DD}$		3.2		pF

(1) All typical values are with respect to nominal V_{DD} and $T_A = 25^\circ\text{C}$.

SWITCHING CHARACTERISTICS

 $V_{DD} = 2.5\text{ V} \pm 10\%$, $C_L = 10\text{ pF}$ (unless otherwise noted)

PARAMETER		TEST CONDITIONS	MIN	TYP ⁽¹⁾	MAX	UNIT
t_{PLH}	Low-to-high propagation delay	See Figure 1 and Figure 2	2	2.9	4.5	ns
t_{PHL}	High-to-low propagation delay		2	3	4.5	
$t_{sk(o)}$	Output skew ⁽²⁾	See Figure 3		50	150	ps
t_r	Output rise slew rate ⁽³⁾		1	2.2	4	V/ns
t_f	Output fall slew rate ⁽³⁾		1	2.2	4	V/ns

- (1) All typical values are with respect to nominal V_{DD} .
 (2) The $t_{sk(o)}$ specification is only valid for equal loading of all outputs and $T_A = -40^\circ\text{C}$ to 85°C .
 (3) This symbol is according to PCI-X terminology.

SWITCHING CHARACTERISTICS

 $V_{DD} = 3.3\text{ V} \pm 10\%$, $C_L = 10\text{ pF}$ (unless otherwise noted)

PARAMETER		TEST CONDITIONS	MIN	TYP ⁽¹⁾	MAX	UNIT
t_{PLH}	Low-to-high propagation delay	See Figure 1 and Figure 2	1.8	2.4	3.8	ns
t_{PHL}	High-to-low propagation delay		1.8	2.5	3.8	
$t_{sk(o)}$	Output skew ⁽²⁾			50	100	ps
t_{jitter}	Additive phase jitter from input to output 1Y0	12 kHz to 5 MHz, $f_{out} = 30.72\text{ MHz}$		63		fs rms
		12 kHz to 20 MHz, $f_{out} = 125\text{ MHz}$		56		
$t_{sk(p)}$	Pulse skew	$V_{IH} = V_{DD}$, $V_{IL} = 0\text{ V}$		180		ps
$t_{sk(pr)}$	Process skew			0.2		ns
$t_{sk(pp)}$	Part-to-part skew			0.25		ns
t_{high}	Clock high time, see Figure 4	66 MHz	6			ns
		140 MHz	2.2			
t_{low}	Clock low time, see Figure 4	66 MHz	6			ns
		140 MHz	3			
t_r	Output rise slew rate ⁽³⁾		1	2.7	4	V/ns
t_f	Output fall slew rate ⁽³⁾		1	2.7	4	V/ns

- (1) All typical values are with respect to nominal V_{DD} .
 (2) The $t_{sk(o)}$ specification is only valid for equal loading of all outputs and $T_A = -40^\circ\text{C}$ to 85°C .
 (3) This symbol is according to PCI-X terminology.

PARAMETER MEASUREMENT INFORMATION

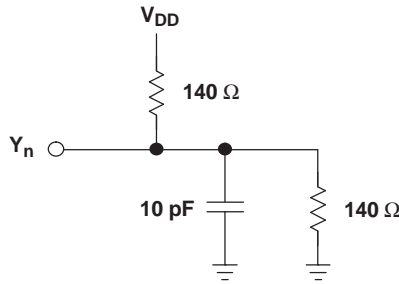

Figure 1. Test Load Circuit

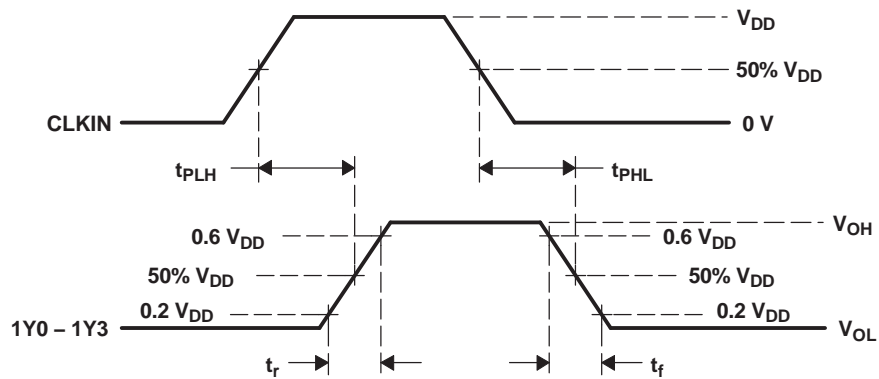

Figure 2. Voltage Waveforms Propagation Delay (t_{pd}) Measurements

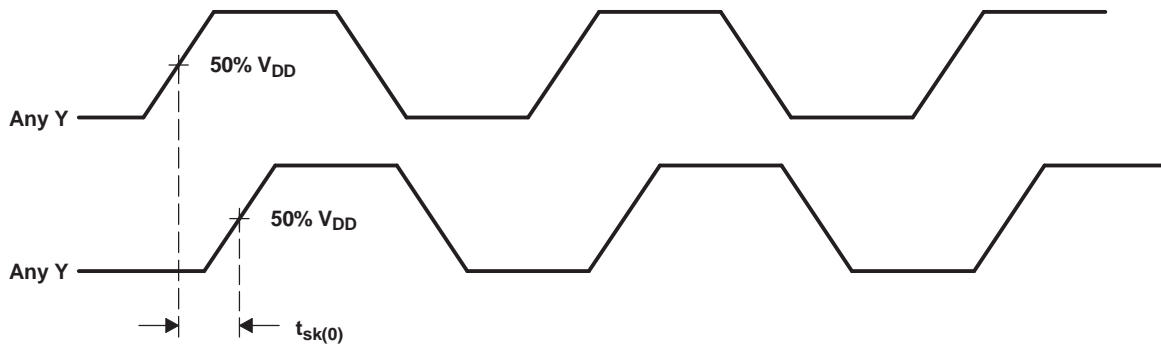
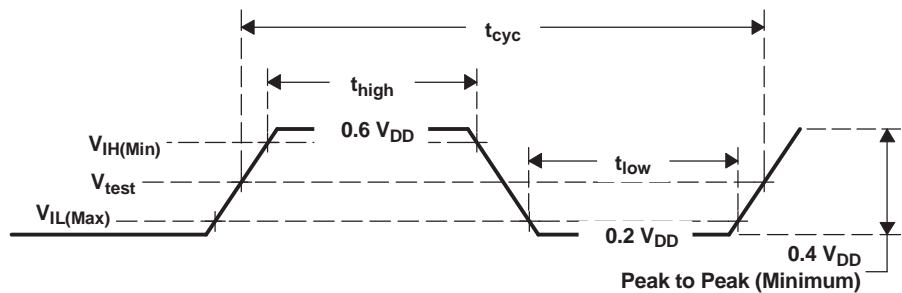

Figure 3. Output Skew

PARAMETER	VALUE	UNIT
$V_{IH}(\text{Min})$	$0.5 V_{DD}$	V
$V_{IL}(\text{Max})$	$0.35 V_{DD}$	V
V_{test}	$0.4 V_{DD}$	V



A. All parameters in Figure 4 are according to PCI-X 1.0 specifications.

Figure 4. Clock Waveform

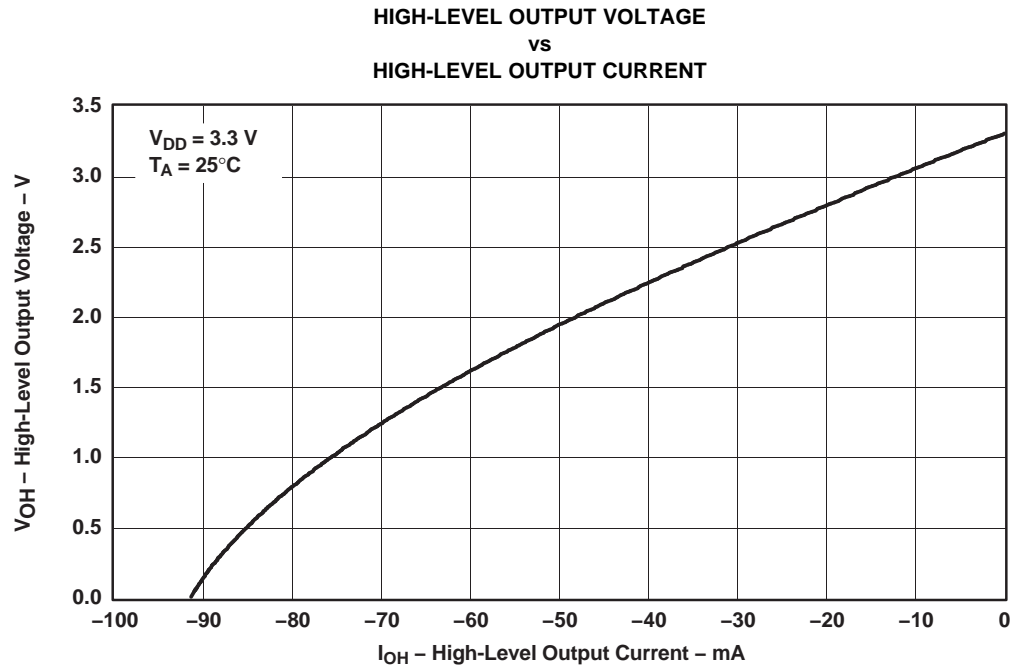

Figure 5.

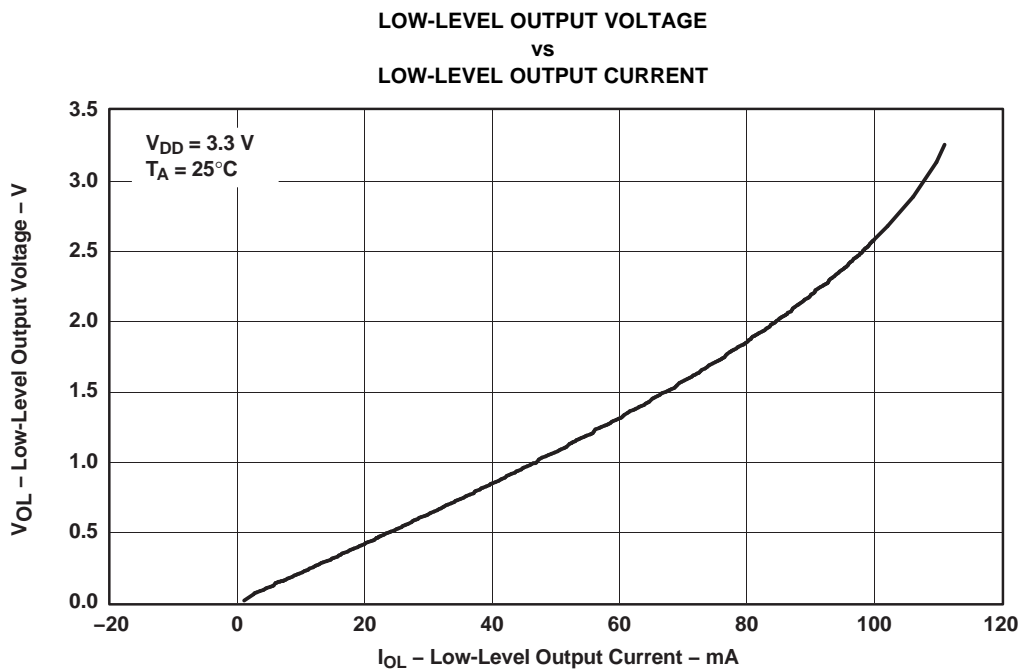

Figure 6.

PACKAGING INFORMATION

Orderable Device	Status (1)	Package Type	Package Drawing	Pins	Package Qty	Eco Plan (2)	Lead finish/ Ball material (6)	MSL Peak Temp (3)	Op Temp (°C)	Device Marking (4/5)	Samples
CDCV304TPWREP	ACTIVE	TSSOP	PW	8	2000	RoHS & Green	NIPDAU	Level-1-260C-UNLIM	-40 to 105	C304T	Samples
V62/12618-01XE	ACTIVE	TSSOP	PW	8	2000	RoHS & Green	NIPDAU	Level-1-260C-UNLIM	-40 to 105	C304T	Samples

(1) The marketing status values are defined as follows:

ACTIVE: Product device recommended for new designs.

LIFEBUY: TI has announced that the device will be discontinued, and a lifetime-buy period is in effect.

NRND: Not recommended for new designs. Device is in production to support existing customers, but TI does not recommend using this part in a new design.

PREVIEW: Device has been announced but is not in production. Samples may or may not be available.

OBSOLETE: TI has discontinued the production of the device.

(2) **RoHS:** TI defines "RoHS" to mean semiconductor products that are compliant with the current EU RoHS requirements for all 10 RoHS substances, including the requirement that RoHS substance do not exceed 0.1% by weight in homogeneous materials. Where designed to be soldered at high temperatures, "RoHS" products are suitable for use in specified lead-free processes. TI may reference these types of products as "Pb-Free".

RoHS Exempt: TI defines "RoHS Exempt" to mean products that contain lead but are compliant with EU RoHS pursuant to a specific EU RoHS exemption.

Green: TI defines "Green" to mean the content of Chlorine (Cl) and Bromine (Br) based flame retardants meet JS709B low halogen requirements of <=1000ppm threshold. Antimony trioxide based flame retardants must also meet the <=1000ppm threshold requirement.

(3) MSL, Peak Temp. - The Moisture Sensitivity Level rating according to the JEDEC industry standard classifications, and peak solder temperature.

(4) There may be additional marking, which relates to the logo, the lot trace code information, or the environmental category on the device.

(5) Multiple Device Markings will be inside parentheses. Only one Device Marking contained in parentheses and separated by a "~" will appear on a device. If a line is indented then it is a continuation of the previous line and the two combined represent the entire Device Marking for that device.

(6) Lead finish/Ball material - Orderable Devices may have multiple material finish options. Finish options are separated by a vertical ruled line. Lead finish/Ball material values may wrap to two lines if the finish value exceeds the maximum column width.

Important Information and Disclaimer:The information provided on this page represents TI's knowledge and belief as of the date that it is provided. TI bases its knowledge and belief on information provided by third parties, and makes no representation or warranty as to the accuracy of such information. Efforts are underway to better integrate information from third parties. TI has taken and continues to take reasonable steps to provide representative and accurate information but may not have conducted destructive testing or chemical analysis on incoming materials and chemicals. TI and TI suppliers consider certain information to be proprietary, and thus CAS numbers and other limited information may not be available for release.

In no event shall TI's liability arising out of such information exceed the total purchase price of the TI part(s) at issue in this document sold by TI to Customer on an annual basis.

OTHER QUALIFIED VERSIONS OF CDCV304-EP :

- Catalog: [CDCV304](#)

NOTE: Qualified Version Definitions:

- Catalog - TI's standard catalog product

TAPE AND REEL INFORMATION

QUADRANT ASSIGNMENTS FOR PIN 1 ORIENTATION IN TAPE

*All dimensions are nominal

Device	Package Type	Package Drawing	Pins	SPQ	Reel Diameter (mm)	Reel Width W1 (mm)	A0 (mm)	B0 (mm)	K0 (mm)	P1 (mm)	W (mm)	Pin1 Quadrant
CDCV304TPWREP	TSSOP	PW	8	2000	330.0	12.4	7.0	3.6	1.6	8.0	12.0	Q1

TAPE AND REEL BOX DIMENSIONS



*All dimensions are nominal

Device	Package Type	Package Drawing	Pins	SPQ	Length (mm)	Width (mm)	Height (mm)
CDCV304TPWREP	TSSOP	PW	8	2000	853.0	449.0	35.0

PW0008A



PACKAGE OUTLINE
TSSOP - 1.2 mm max height

SMALL OUTLINE PACKAGE



NOTES:

1. All linear dimensions are in millimeters. Any dimensions in parenthesis are for reference only. Dimensioning and tolerancing per ASME Y14.5M.
2. This drawing is subject to change without notice.
3. This dimension does not include mold flash, protrusions, or gate burrs. Mold flash, protrusions, or gate burrs shall not exceed 0.15 mm per side.
4. This dimension does not include interlead flash. Interlead flash shall not exceed 0.25 mm per side.
5. Reference JEDEC registration MO-153, variation AA.

EXAMPLE BOARD LAYOUT

PW0008A

TSSOP - 1.2 mm max height

SMALL OUTLINE PACKAGE



LAND PATTERN EXAMPLE
SCALE:10X



SOLDER MASK DETAILS
NOT TO SCALE

4221848/A 02/2015

NOTES: (continued)

- 6. Publication IPC-7351 may have alternate designs.
- 7. Solder mask tolerances between and around signal pads can vary based on board fabrication site.

EXAMPLE STENCIL DESIGN

PW0008A

TSSOP - 1.2 mm max height

SMALL OUTLINE PACKAGE



SOLDER PASTE EXAMPLE
BASED ON 0.125 mm THICK STENCIL
SCALE:10X

4221848/A 02/2015

NOTES: (continued)

8. Laser cutting apertures with trapezoidal walls and rounded corners may offer better paste release. IPC-7525 may have alternate design recommendations.
9. Board assembly site may have different recommendations for stencil design.

IMPORTANT NOTICE AND DISCLAIMER

TI PROVIDES TECHNICAL AND RELIABILITY DATA (INCLUDING DATASHEETS), DESIGN RESOURCES (INCLUDING REFERENCE DESIGNS), APPLICATION OR OTHER DESIGN ADVICE, WEB TOOLS, SAFETY INFORMATION, AND OTHER RESOURCES "AS IS" AND WITH ALL FAULTS, AND DISCLAIMS ALL WARRANTIES, EXPRESS AND IMPLIED, INCLUDING WITHOUT LIMITATION ANY IMPLIED WARRANTIES OF MERCHANTABILITY, FITNESS FOR A PARTICULAR PURPOSE OR NON-INFRINGEMENT OF THIRD PARTY INTELLECTUAL PROPERTY RIGHTS.

These resources are intended for skilled developers designing with TI products. You are solely responsible for (1) selecting the appropriate TI products for your application, (2) designing, validating and testing your application, and (3) ensuring your application meets applicable standards, and any other safety, security, or other requirements. These resources are subject to change without notice. TI grants you permission to use these resources only for development of an application that uses the TI products described in the resource. Other reproduction and display of these resources is prohibited. No license is granted to any other TI intellectual property right or to any third party intellectual property right. TI disclaims responsibility for, and you will fully indemnify TI and its representatives against, any claims, damages, costs, losses, and liabilities arising out of your use of these resources.

TI's products are provided subject to TI's Terms of Sale (www.ti.com/legal/termsofsale.html) or other applicable terms available either on ti.com or provided in conjunction with such TI products. TI's provision of these resources does not expand or otherwise alter TI's applicable warranties or warranty disclaimers for TI products.

Mailing Address: Texas Instruments, Post Office Box 655303, Dallas, Texas 75265
Copyright © 2020, Texas Instruments Incorporated