

SURFACE MOUNT CERMET TRIMMERS (3 TURNS) **ST-7**

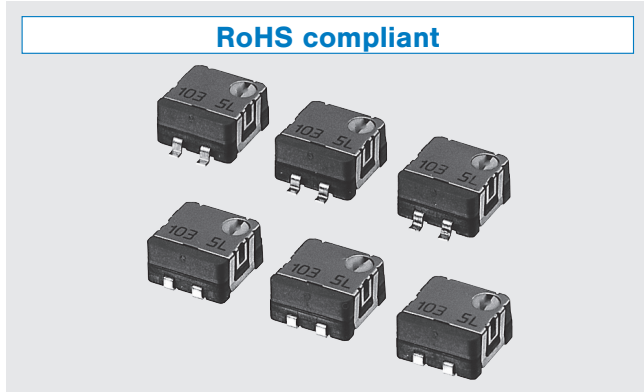

FEATURES

- RoHS compliant
- Fine adjustment is possible
- Automatic mounting is possible (Taping)
- Flow/reflow soldering is possible
- Sealed construction (Washable: Refer to page 698.)
- Resin material is UL Recognized 94V-0

INTERNAL STRUCTURE	
Part name	Material
① Rotor gear	Polyphenylenesulphide
② Base element	Ceramic
③ Terminal pin	Copper alloy, Sn-Cu-plated
④ Resistive element	RuO ₂ cermet
⑤ Electrode	Ag-Pd cermet
⑥ Housing base	Polyphenylenesulphide
⑦ Wiper	Multi metal alloy
⑧ Shaft	Polyphenylenesulphide
⑨ Housing	
⑩ Shaft "O" ring	Silicone rubber
⑪ Base "O" ring	
⑫ Clutch spring	Stainless steel
⑬ Cover	

PART NUMBER DESIGNATION

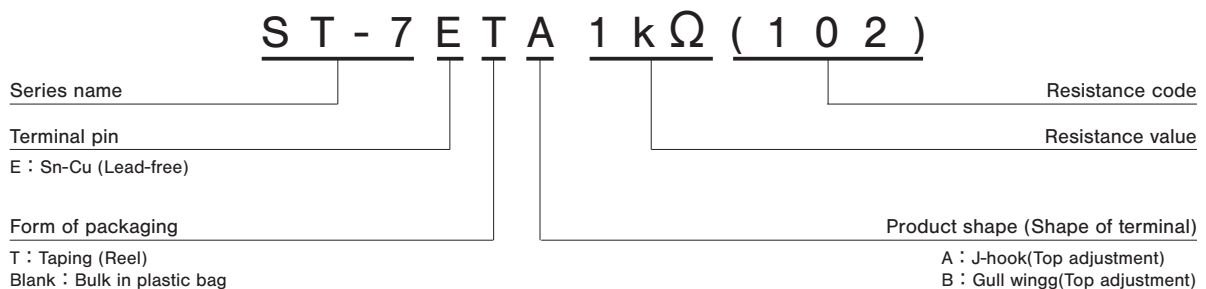

※ Please refer to the LIST OF PART NUMBERS when placing orders.

ST-7

SURFACE MOUNT TRIMMERS

LIST OF PART NUMBERS

Adjustment position	Shape of terminal	Form of packaging	
		Taping (reel)	Plastic bag
Top adjustment	A (J-hook)	ST-7ETA	ST-7EA
	B (Gull wing)	ST-7ETB	ST-7EB
Pieces in package		500 pcs./reel	50 pcs./pack

<Nominal resistance values>

50 Ω	100 Ω	200 Ω	500 Ω	1 kΩ	2 kΩ	5 kΩ
10 kΩ	20 kΩ	50 kΩ	100 kΩ	200 kΩ	500 kΩ	1 MΩ

Fig. 1

※ The above part numbers are all available with the respective combination of <Nominal resistance values> (Fig. 1).

※ Verify the above part numbers when placing orders.

※ Taping specification is not sold separately and must be purchased in reel units.

ELECTRICAL CHARACTERISTICS

Nominal resistance range	50 Ω ~ 1 MΩ
Resistance tolerance	± 20 %
Power ratings	0.25 W (70 °C) 0 W (125 °C)
Resistance law	Linear law
Maximum input voltage	DC200 V or power rating, whichever is smaller
Maximum wiper current	100 mA or power rating, whichever is smaller
Effective electrical turn	2.5 turns
End resistance	1 % or 2 Ω, whichever is greater
C.R.V.	1 % or 3 Ω, whichever is greater
Operating temp. range	- 55 ~ 125 °C
Temp. coefficient	50 Ω : ± 250 10 ⁻⁶ /°C maximum 100 Ω ~ 1 MΩ : ± 100 10 ⁻⁶ /°C maximum
Insulation resistance	1000 MΩ minimum (DC500 V)
Dielectric strength	AC600 V, 60 s
Net weight	Approx. 0.25 g

MECHANICAL CHARACTERISTICS

Mechanical turn	3 turns
Operating torque	5 mN·m {51 gf·cm} maximum
Mechanical stop	Clutch action
Rotational life	100 cycles [Δ R/R ≤ ± (2 Ω + 3 %)]
Thrust to shaft	5 N {0.51 kgf} minimum
Solderability	245 ± 3 °C, 2 ~ 3 s
Shear (Adhesion)	5 N {0.51 kgf} 10 s
Substrate bending	Width 90 mm, bend 3 mm, 5 s, 1 time
Pull-off strength	5 N {0.51 kgf} 10 s

{ } : Reference only

ENVIRONMENTAL CHARACTERISTICS

Test item	Test conditions	Specifications
Thermal shock	- 65 ~ 125 °C (0.5 h), 5 cycles	[Δ R/R ≤ 2 %] [S.S. ≤ 1 %]
Humidity	- 10 ~ 65 °C (80 ~ 98 %), 10 cycles, 240 h	[Δ R/R ≤ 2 %]
Shock	981 m/s ² , 6 ms 6 directions for 3 times each	[Δ R/R ≤ 1 %] [S.S. ≤ 1 %]
Vibration	(Amplitude) 1.52 mm or (Acceleration) 196 m/s ² , 10 ~ 2000 Hz, 3 directions, 12 times each	
Load life	70 °C, 0.25 W, 1000 h	[Δ R/R ≤ 3 %] [S.S. ≤ 1 %]
Low temp. operation	- 55 °C, 2 h	[Δ R/R ≤ 2 %] [S.S. ≤ 2 %]
High temp. exposure	125 °C, 250 h	[Δ R/R ≤ 3 %] [S.S. ≤ 2 %]
Immersion seal	85 °C, 60 s	No leaks (No continuous bubbles)
Soldering heat	Flow : 260 ± 3 °C as the temperature in a pot of molten solder, immersion from head of terminal to backside of board, 5 ~ 6 s, two times maximum Reflow : Peak temperature 255 °C (Please refer to the profile below.) Manual soldering : 350 ± 10 °C, 3 ~ 4 s	[Δ R/R ≤ 1 %]

<Reflow profile for soldering heat evaluation>

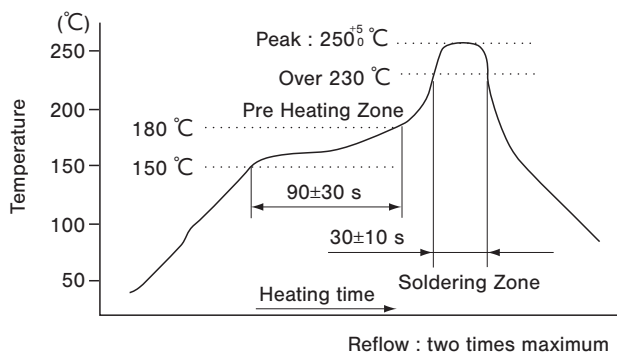

Δ R/R : Change in total resistance
S.S. : Setting stability

ST-7

SURFACE MOUNT TRIMMERS

MAXIMUM INPUT RATINGS

Nominal resistance values (Ω)	Resistance code	Maximum input voltage (V)	Maximum wiper current (mA)
50	500	3.53	70.7
100	101	5.00	50.0
200	201	7.07	35.4
500	501	11.2	22.4
1 k	102	15.8	15.8
2 k	202	22.4	11.2
5 k	502	35.4	7.07
10 k	103	50.0	5.00
20 k	203	70.7	3.54
50 k	503	112	2.24
100 k	104	158	1.58
200 k	204	200	1.00
500 k	504	200	0.40
1 M	105	200	0.20

RECOMMENDED P.C.B. PAD OUTLINE DIMENSIONS

ST-7EA

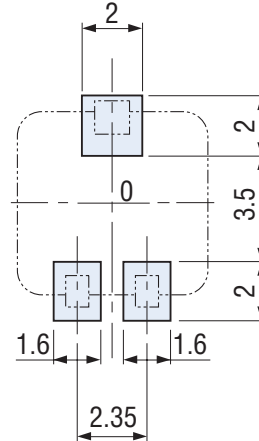

ST-7EB

(Unit: mm)

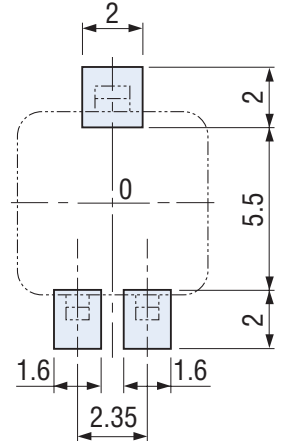

Note) The zero point is the center of mounting.

OUTLINE DIMENSIONS

ST-7EA

Top adjustment

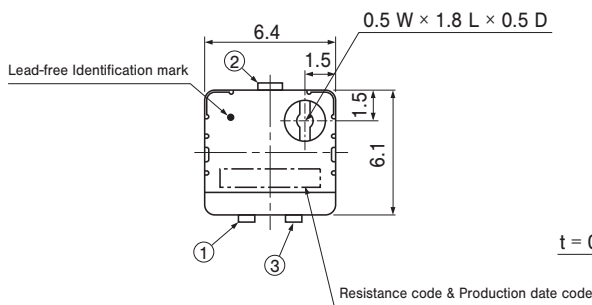

Unless otherwise specified, tolerance : ± 0.3 (Unit : mm)

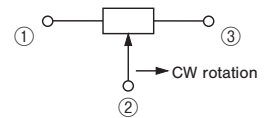

ST-7EB

Top adjustment

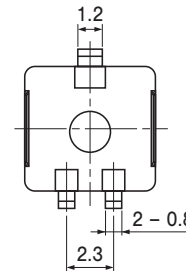
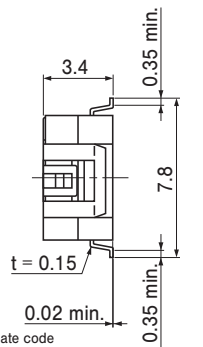
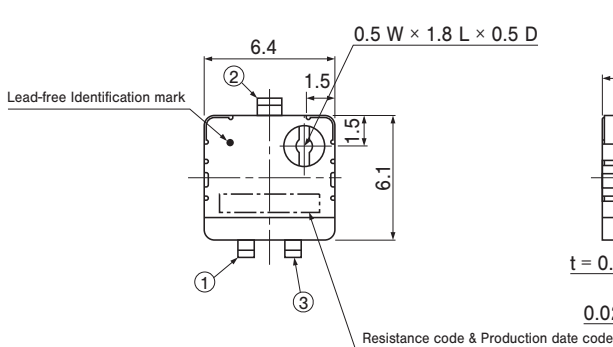

※ The ST-7 series has a different terminal arrangement from the ST-32 and ST-4 series. Pay attention to the location of terminals number 1 and 3. (Resistance decreases when the shaft is turned CCW.)

ST-7

SURFACE MOUNT TRIMMERS

PACKAGING SPECIFICATIONS

<Taping packaging specifications>

- Taping version is packaged in 500 pcs. per reel.
Orders will be accepted for units of 500 pcs., i.e., 500, 1000, 1500 pcs., etc.
- Taping version is boxed with one reel (500 pcs.).

Maximum number of consecutive missing pieces = 2
Leader length and reel dimension are shown in the diagrams below.

EMBOSED TAPE DIMENSIONS

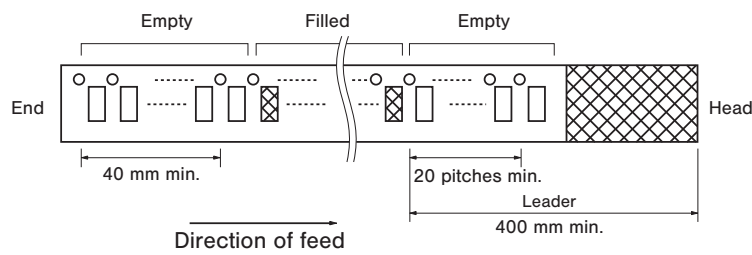

REEL DIMENSIONS

(Conforms to JIS C 0806-3)
(In accordance with EIAJ ET-7200A)

(Unit: mm)

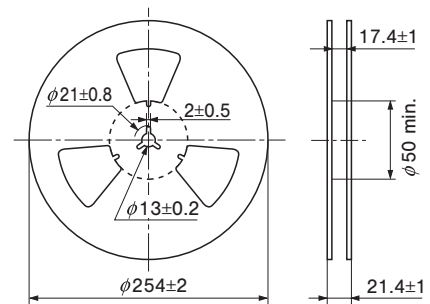

ST-7ETA

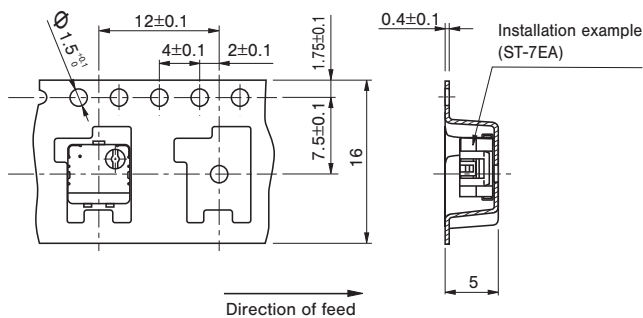

ST-7ETB

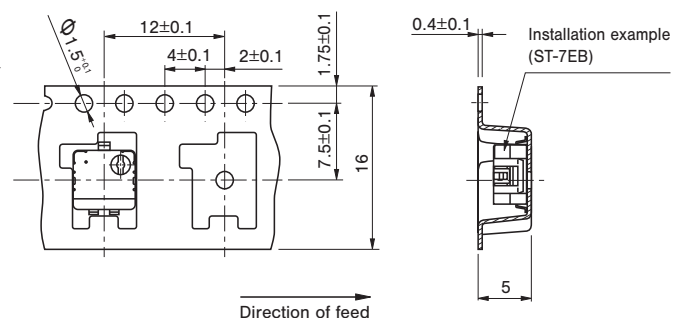

<Bulk pack packaging specifications>

- Unit of bulk in a plastic bag is 50 pcs. per pack.
- Boxing of bulk in a plastic bag is performed with 200 pcs. per box.