

### FEATURES

- Operating frequency from 100 MHz to 4000 MHz
- Digitally controlled VGA with serial and parallel interfaces
- 6-bit, 0.5 dB digital step attenuator
- 31.5 dB gain control range with  $\pm 0.25$  dB step accuracy
- Gain block amplifier specifications
  - Gain: 19.7 dB at 2.14 GHz
  - OIP3: 41.0 dBm at 2.14 GHz
  - P1dB: 19.5 dBm at 2.14 GHz
  - Noise figure: 2.9 dB at 2.14 GHz
- Gain block or digital step attenuator can be first
- Single supply operation from 4.75 V to 5.25 V
- Low quiescent current of 93 mA
- Thermally efficient, 5 mm  $\times$  5 mm, 32-lead LFCSP
- The companion [ADL5243](#) integrates a  $\frac{1}{4}$  W driver amplifier to the output of the gain block and DSA

### APPLICATIONS

- Wireless infrastructure
- Automated test equipment
- RF/IF gain control

### GENERAL DESCRIPTION

The [ADL5240](#) is a high performance, digitally controlled variable gain amplifier (VGA) operating from 100 MHz to 4000 MHz. The VGA integrates a high performance, 20 dB gain, internally matched amplifier (AMP) with a 6-bit digital step attenuator (DSA) that has a gain control range of 31.5 dB in 0.5 dB steps with  $\pm 0.25$  dB step accuracy. The attenuation of the DSA can be controlled using a serial or parallel interface.

Both the gain block and DSA are internally matched to 50  $\Omega$  at their inputs and outputs and are separately biased. The separate bias allows all or part of the [ADL5240](#) to be used, which facilitates easy reuse throughout a design. The pinout of the [ADL5240](#) also enables either the gain block or DSA to be first, giving the VGA maximum flexibility in a signal chain.

The [ADL5240](#) consumes just 93 mA and operates from a single supply ranging from 4.75 V to 5.25 V. The VGA is packaged in a thermally efficient, 5 mm  $\times$  5 mm, 32-lead LFCSP and is fully specified for operation from  $-40^{\circ}\text{C}$  to  $+85^{\circ}\text{C}$ . A fully populated evaluation board is available.

### FUNCTIONAL BLOCK DIAGRAM

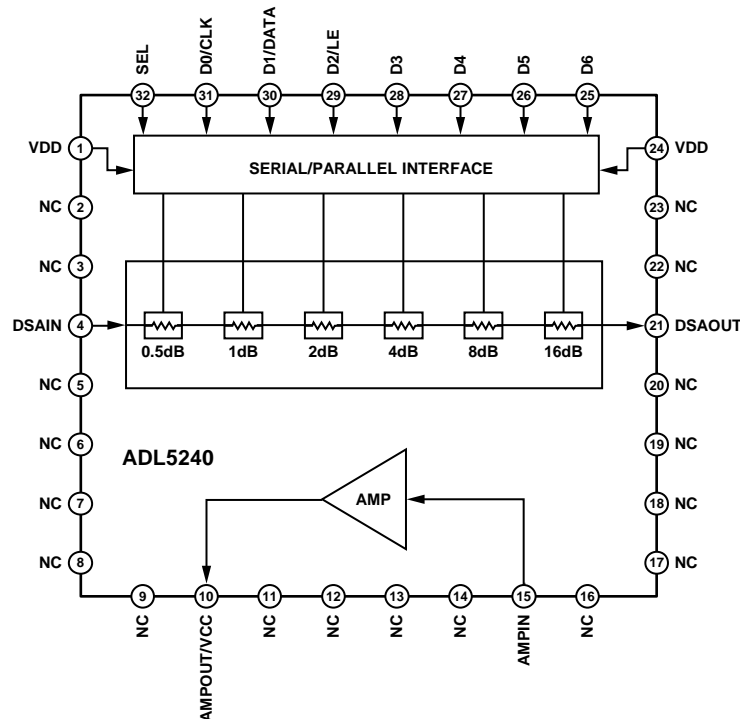

Figure 1.

Rev. A

[Document Feedback](#)

Information furnished by Analog Devices is believed to be accurate and reliable. However, no responsibility is assumed by Analog Devices for its use, nor for any infringements of patents or other rights of third parties that may result from its use. Specifications subject to change without notice. No license is granted by implication or otherwise under any patent or patent rights of Analog Devices. Trademarks and registered trademarks are the property of their respective owners.

## TABLE OF CONTENTS

Features .....	1	Applications Information .....	16
Applications.....	1	Basic Layout Connections.....	16
General Description .....	1	SPI Timing.....	18
Functional Block Diagram .....	1	Loop Performance.....	20
Revision History .....	2	Amplifier Drive Level for Optimum ACLR.....	22
Specifications.....	3	Thermal Considerations.....	22
Absolute Maximum Ratings.....	8	Evaluation Board .....	23
ESD Caution.....	8	Outline Dimensions .....	28
Pin Configuration and Function Descriptions.....	9	Ordering Guide .....	28
Typical Performance Characteristics .....	10		

## REVISION HISTORY

### 6/13—Rev. 0 to Rev. A

Changes to Table 1.....	4
Changes to Table 3.....	9
Changes to Figure 3.....	11
Changes to Figure 16.....	12
Added Figure 29, Renumbered Sequentially .....	14
Changes to Table 5, Figure 35, and Figure 36 .....	18
Added Amplifier Drive Level for Optimum ACLR Section and Figure 39.....	22
Changes to Evaluation Board Section.....	23
Changes to Figure 41 and Table 8.....	24
Added Figure 42.....	25
Changes to Figure 43 and Figure 44.....	26
Added Figure 45.....	27

### 7/11—Revision 0: Initial Version

## SPECIFICATIONS

VDD = 5 V, VCC = 5 V, T<sub>A</sub> = 25°C

Table 1.

Parameter	Test Conditions/Comments	Min	Typ	Max	Unit
OVERALL FUNCTION					
Frequency Range		100		4000	MHz
AMPLIFIER FREQUENCY = 150 MHz	Using the AMPIN and AMPOUT pins				
Gain			17.6		dB
vs. Frequency	±50 MHz		±1.0		dB
vs. Temperature	-40°C ≤ T <sub>A</sub> ≤ +85°C		±0.04		dB
vs. Supply	4.75 V to 5.25 V		±0.04		dB
Input Return Loss	S11		-10.4		dB
Output Return Loss	S22		-7.7		dB
Output 1 dB Compression Point			18.3		dBm
Output Third-Order Intercept	Δf = 1 MHz, P <sub>OUT</sub> = 4 dBm/tone		30.0		dBm
Noise Figure			2.8		dB
AMPLIFIER FREQUENCY = 450 MHz	Using the AMPIN and AMPOUT pins				
Gain			20.3		dB
vs. Frequency	±50 MHz		±0.11		dB
vs. Temperature	-40°C ≤ T <sub>A</sub> ≤ +85°C		±0.36		dB
vs. Supply	4.75 V to 5.25 V		±0.01		dB
Input Return Loss	S11		-18.3		dB
Output Return Loss	S22		-15.7		dB
Output 1 dB Compression Point			20.2		dBm
Output Third-Order Intercept	Δf = 1 MHz, P <sub>OUT</sub> = 4 dBm/tone		39.0		dBm
Noise Figure			2.9		dB
AMPLIFIER FREQUENCY = 748 MHz	Using the AMPIN and AMPOUT pins				
Gain			20.6		dB
vs. Frequency	±50 MHz		±0.01		dB
vs. Temperature	-40°C ≤ T <sub>A</sub> ≤ +85°C		±0.31		dB
vs. Supply	4.75 V to 5.25 V		±0.01		dB
Input Return Loss	S11		-25.7		dB
Output Return Loss	S22		-23.7		dB
Output 1 dB Compression Point			20.2		dBm
Output Third-Order Intercept	Δf = 1 MHz, P <sub>OUT</sub> = 4 dBm/tone		40.0		dBm
Noise Figure			2.7		dB
AMPLIFIER FREQUENCY = 943 MHz	Using the AMPIN and AMPOUT pins				
Gain		19.0	20.5	22.0	dB
vs. Frequency	±18 MHz		±0.01		dB
vs. Temperature	-40°C ≤ T <sub>A</sub> ≤ +85°C		±0.27		dB
vs. Supply	4.75 V to 5.25 V		±0.01		dB
Input Return Loss	S11		-30.3		dB
Output Return Loss	S22		-24.8		dB
Output 1 dB Compression Point		18.5	20.1		dBm
Output Third-Order Intercept	Δf = 1 MHz, P <sub>OUT</sub> = 4 dBm/tone		40.0		dBm
Noise Figure			2.7		dB

Parameter	Test Conditions/Comments	Min	Typ	Max	Unit
<b>AMPLIFIER FREQUENCY = 1960 MHz</b>					
Gain	Using the AMPIN and AMPOUT pins		19.8		dB
vs. Frequency	±30 MHz		±0.03		dB
vs. Temperature	−40°C ≤ T <sub>A</sub> ≤ +85°C		±0.26		dB
vs. Supply	4.75 V to 5.25 V		±0.03		dB
Input Return Loss	S11		−11.9		dB
Output Return Loss	S22		−12.6		dB
Output 1 dB Compression Point			19.8		dBm
Output Third-Order Intercept	Δf = 1 MHz, P <sub>OUT</sub> = 4 dBm/tone		40.0		dBm
Noise Figure			2.9		dB
<b>AMPLIFIER FREQUENCY = 2140 MHz</b>					
Gain	Using the AMPIN and AMPOUT pins	18.0	19.7	22.0	dB
vs. Frequency	±30 MHz		±0.02		dB
vs. Temperature	−40°C ≤ T <sub>A</sub> ≤ +85°C		±0.25		dB
vs. Supply	4.75 V to 5.25 V		±0.04		dB
Input Return Loss	S11		−11.0		dB
Output Return Loss	S22		−12.0		dB
Output 1 dB Compression Point		17.5	19.5		dBm
Output Third-Order Intercept	Δf = 1 MHz, P <sub>OUT</sub> = 4 dBm/tone		41.0		dBm
Noise Figure			2.9		dB
<b>AMPLIFIER FREQUENCY = 2630 MHz</b>					
Gain	Using the AMPIN and AMPOUT pins	18.0	19.6	22.0	dB
vs. Frequency	±60 MHz		±0.01		dB
vs. Temperature	−40°C ≤ T <sub>A</sub> ≤ +85°C		±0.22		dB
vs. Supply	4.75 V to 5.25 V		±0.04		dB
Input Return Loss	S11		−11.0		dB
Output Return Loss	S22		−13.3		dB
Output 1 dB Compression Point		18.0	19.9		dBm
Output Third-Order Intercept	Δf = 1 MHz, P <sub>OUT</sub> = 4 dBm/tone		41.0		dBm
Noise Figure			2.9		dB
<b>AMPLIFIER FREQUENCY = 3600 MHz</b>					
Gain	Using the AMPIN and AMPOUT pins		19.6		dB
vs. Frequency	±100 MHz		±0.03		dB
vs. Temperature	−40°C ≤ T <sub>A</sub> ≤ +85°C		±0.05		dB
vs. Supply	4.75 V to 5.25 V		±0.10		dB
Input Return Loss	S11		−15.1		dB
Output Return Loss	S22		−12.2		dB
Output 1 dB Compression Point			18.8		dBm
Output Third-Order Intercept	Δf = 1 MHz, P <sub>OUT</sub> = 4 dBm/tone		37.0		dBm
Noise Figure			3.1		dB
<b>DSA FREQUENCY = 150 MHz</b>					
Insertion Loss	Using the DSAIN and DSAOUT pins		−1.5		dB
vs. Frequency	Minimum attenuation		±0.12		dB
vs. Temperature	±50 MHz		±0.09		dB
Attenuation Range	−40°C ≤ T <sub>A</sub> ≤ +85°C		28.8		dB
Attenuation Step Error	All attenuation states		±0.18		dB
Attenuation Absolute Error	All attenuation states		±1.35		dB
Input Return Loss	Minimum attenuation		−13.3		dB
Output Return Loss	Minimum attenuation		−13.4		dB
Input Third-Order Intercept	Δf = 1 MHz, P <sub>OUT</sub> = 4 dBm/tone, minimum attenuation		47.9		dBm

Parameter	Test Conditions/Comments	Min	Typ	Max	Unit
DSA FREQUENCY = 450 MHz	Using the DSAIN and DSAOUT pins				
Insertion Loss	Minimum attenuation		-1.5		dB
vs. Frequency	$\pm 50$ MHz		$\pm 0.02$		dB
vs. Temperature	$-40^{\circ}\text{C} \leq T_A \leq +85^{\circ}\text{C}$		$\pm 0.10$		dB
Attenuation Range			30.7		dB
Attenuation Step Error	All attenuation states		$\pm 0.14$		dB
Attenuation Absolute Error	All attenuation states		$\pm 0.42$		dB
Input Return Loss	Minimum attenuation		-17.6		dB
Output Return Loss	Minimum attenuation		-17.6		dB
Input Third-Order Intercept	$\Delta f = 1$ MHz, $P_{\text{OUT}} = 4$ dBm/tone, minimum attenuation		45.0		dBm
DSA FREQUENCY = 748 MHz	Using the DSAIN and DSAOUT pins				
Insertion Loss	Minimum attenuation		-1.6		dB
vs. Frequency	$\pm 50$ MHz		$\pm 0.02$		dB
vs. Temperature	$-40^{\circ}\text{C} \leq T_A \leq +85^{\circ}\text{C}$		$\pm 0.11$		dB
Attenuation Range			30.9		dB
Attenuation Step Error	All attenuation states		$\pm 0.15$		dB
Attenuation Absolute Error	All attenuation states		$\pm 0.32$		dB
Input Return Loss	Minimum attenuation		-17.4		dB
Output Return Loss	Minimum attenuation		-17.4		dB
Input Third-Order Intercept	$\Delta f = 1$ MHz, $P_{\text{OUT}} = 4$ dBm/tone, minimum attenuation		43.5		dBm
DSA FREQUENCY = 943 MHz	Using the DSAIN and DSAOUT pins				
Insertion Loss	Minimum attenuation		-1.6		dB
vs. Frequency	$\pm 18$ MHz		$\pm 0.01$		dB
vs. Temperature	$-40^{\circ}\text{C} \leq T_A \leq +85^{\circ}\text{C}$		$\pm 0.12$		dB
Attenuation Range			30.9		dB
Attenuation Step Error	All attenuation states		$\pm 0.13$		dB
Attenuation Absolute Error	All attenuation states		$\pm 0.30$		dB
Input Return Loss	Minimum attenuation		-16.6		dB
Output Return Loss	Minimum attenuation		-16.5		dB
Input 1 dB Compression Point	Minimum attenuation		30.5		dBm
Input Third-Order Intercept	$\Delta f = 1$ MHz, $P_{\text{OUT}} = 4$ dBm/tone, minimum attenuation		50.9		dBm
DSA FREQUENCY = 1960 MHz	Using the DSAIN and DSAOUT pins				
Insertion Loss	Minimum attenuation		-2.4		dB
vs. Frequency	$\pm 30$ MHz		$\pm 0.02$		dB
vs. Temperature	$-40^{\circ}\text{C} \leq T_A \leq +85^{\circ}\text{C}$		$\pm 0.16$		dB
Attenuation Range			31.0		dB
Attenuation Step Error	All attenuation states		$\pm 0.15$		dB
Attenuation Absolute Error	All attenuation states		$\pm 0.29$		dB
Input Return Loss	Minimum attenuation		-12.0		dB
Output Return Loss	Minimum attenuation		-11.5		dB
Input 1 dB Compression Point	Minimum attenuation		31.5		dBm
Input Third-Order Intercept	$\Delta f = 1$ MHz, $P_{\text{OUT}} = 4$ dBm/tone, minimum attenuation		49.5		dBm
DSA FREQUENCY = 2140 MHz	Using the DSAIN and DSAOUT pins				
Insertion Loss	Minimum attenuation		-2.5		dB
vs. Frequency	$\pm 30$ MHz		$\pm 0.02$		dB
vs. Temperature	$-40^{\circ}\text{C} \leq T_A \leq +85^{\circ}\text{C}$		$\pm 0.17$		dB
Attenuation Range			31.0		dB
Attenuation Step Error	All attenuation states		$\pm 0.12$		dB
Attenuation Absolute Error	All attenuation states		$\pm 0.26$		dB
Input Return Loss	Minimum attenuation		-11.9		dB
Output Return Loss	Minimum attenuation		-11.2		dB
Input 1 dB Compression Point	Minimum attenuation		31.5		dBm
Input Third-Order Intercept	$\Delta f = 1$ MHz, $P_{\text{OUT}} = 4$ dBm/tone, minimum attenuation		49.2		dBm

Parameter	Test Conditions/Comments	Min	Typ	Max	Unit
DSA FREQUENCY = 2630 MHz	Using the DSAIN and DSAOUT pins				
Insertion Loss	Minimum attenuation		-2.6		dB
vs. Frequency	$\pm 60$ MHz		$\pm 0.04$		dB
vs. Temperature	$-40^{\circ}\text{C} \leq T_A \leq +85^{\circ}\text{C}$		$\pm 0.19$		dB
Attenuation Range			31.2		dB
Attenuation Step Error	All attenuation states		$\pm 0.16$		dB
Attenuation Absolute Error	All attenuation states		$\pm 0.19$		dB
Input Return Loss	Minimum attenuation		-13.1		dB
Output Return Loss	Minimum attenuation		-12.0		dB
Input 1 dB Compression Point	Minimum attenuation		31.5		dBm
Input Third-Order Intercept	$\Delta f = 1$ MHz, $P_{\text{OUT}} = 4$ dBm/tone, minimum attenuation		47.6		dBm
DSA FREQUENCY = 3600 MHz	Using the DSAIN and DSAOUT pins				
Insertion Loss	Minimum attenuation		-2.8		dB
vs. Frequency	$\pm 100$ MHz		$\pm 0.03$		dB
vs. Temperature	$-40^{\circ}\text{C} \leq T_A \leq +85^{\circ}\text{C}$		$\pm 0.21$		dB
Attenuation Range			32.1		dB
Attenuation Step Error	All attenuation states		$\pm 0.37$		dB
Attenuation Absolute Error	All attenuation states		$\pm 0.31$		dB
Input Return Loss	Minimum attenuation		-20.2		dB
Output Return Loss	Minimum attenuation		-18.2		dB
Input 1 dB Compression Point	Minimum attenuation		31.0		dBm
Input Third-Order Intercept	$\Delta f = 1$ MHz, $P_{\text{OUT}} = 4$ dBm/tone, minimum attenuation		48.5		dBm
DIGITAL STEP ATTENUATOR GAIN SETTling					
Minimum Attenuation to Maximum Attenuation			36		ns
Maximum Attenuation to Minimum Attenuation			36		ns
AMP-DSA LOOP FREQUENCY = 943 MHz	Using the AMPIN and DSAOUT pins, DSA at minimum attenuation				
Gain			18.9		dB
vs. Frequency	$\pm 18$ MHz		$\pm 0.01$		dB
Gain Range	Between maximum and minimum attenuation states		30.8		dB
Input Return Loss	S11		-20.5		dB
Output Return Loss	S22		-19.7		dB
Output 1 dB Compression Point			18.6		dBm
Output Third-Order Intercept	$\Delta f = 1$ MHz, $P_{\text{OUT}} = 1$ dBm/tone		36.0		dBm
Noise Figure			2.7		dB
AMP-DSA LOOP FREQUENCY = 2140 MHz	Using the AMPIN and DSAOUT pins, DSA at minimum attenuation				
Gain			18.2		dB
vs. Frequency	$\pm 30$ MHz		$\pm 0.01$		dB
Gain Range	Between maximum and minimum attenuation states		31.3		dB
Input Return Loss	S11		-14.9		dB
Output Return Loss	S22		-16.4		dB
Output 1 dB Compression Point			17.9		dBm
Output Third-Order Intercept	$\Delta f = 1$ MHz, $P_{\text{OUT}} = 1$ dBm/tone		37.5		dBm
Noise Figure			3.0		dB

Parameter	Test Conditions/Comments	Min	Typ	Max	Unit
<b>AMP-DSA LOOP FREQUENCY = 2630 MHz</b>					
	Using the AMPIN and DSAOUT pins, DSA at minimum attenuation				
Gain			17.7		dB
vs. Frequency	±60 MHz		±0.11		dB
Gain Range			31.5		dB
Input Return Loss	S11		-15.2		dB
Output Return Loss	S22		-9.6		dB
Output 1 dB Compression Point			16.9		dBm
Output Third-Order Intercept	$\Delta f = 1 \text{ MHz}, P_{\text{OUT}} = 1 \text{ dBm/tone}$		33.7		dBm
Noise Figure			3.0		dB
<b>DSA-AMP LOOP FREQUENCY = 943 MHz</b>					
	Using the DSAIN and AMPOUT pins, DSA at minimum attenuation				
Gain			18.9		dB
vs. Frequency	±18 MHz		±0.01		dB
Gain Range	Between maximum and minimum attenuation states		30.8		dB
Input Return Loss	S11		-17.2		dB
Output Return Loss	S22		-23.7		dB
Output 1 dB Compression Point			20.2		dBm
Output Third-Order Intercept	$\Delta f = 1 \text{ MHz}, P_{\text{OUT}} = 4 \text{ dBm/tone}$		40.0		dBm
Noise Figure			4.4		dB
<b>DSA-AMP LOOP Frequency = 2140 MHz</b>					
	Using the DSAIN and AMPOUT pins, DSA at minimum attenuation				
Gain			18.0		dB
vs. Frequency	±30 MHz		±0.01		dB
Gain Range	Between maximum and minimum attenuation states		31.1		dB
Input Return Loss	S11		-13.7		dB
Output Return Loss	S22		-10.0		dB
Output 1 dB Compression Point			19.7		dBm
Output Third-Order Intercept	$\Delta f = 1 \text{ MHz}, P_{\text{OUT}} = 4 \text{ dBm/tone}$		37.5		dBm
Noise Figure			4.9		dB
<b>DSA-AMP LOOP Frequency = 2630 MHz</b>					
	Using the DSAIN and AMPOUT pins, DSA at minimum attenuation				
Gain			18.2		dB
vs. Frequency	±60 MHz		±0.01		dB
Gain Range	Between maximum and minimum attenuation states		31.7		dB
Input Return Loss	S11		-15.7		dB
Output Return Loss	S22		-16.9		dB
Output 1 dB Compression Point			19.8		dBm
Output Third-Order Intercept	$\Delta f = 1 \text{ MHz}, P_{\text{OUT}} = 4 \text{ dBm/tone}$		40.8		dBm
Noise Figure			5.2		dB
<b>LOGIC INPUTS</b>					
	CLK, DATA, LE, SEL, D0~D6				
Input High Voltage, VINH		2.5			V
Input Low Voltage, VINL				0.8	V
Input Current, IINH/IINL			0.1		μA
Input Capacitance, CIN			1.5		pF
<b>POWER SUPPLIES</b>					
	Using the VDD and VCC pins				
Voltage		4.75	5.0	5.25	V
Supply Current					
Amplifier			93	120	mA
Digital Step Attenuator			0.5		mA

## ABSOLUTE MAXIMUM RATINGS

Table 2.

Parameter	Rating
Supply Voltage (VDD, VCC)	6.5 V
Input Power	
AMPIN	16 dBm
DSAIN	30 dBm
Internal Power Dissipation	0.5 W
$\theta_{JA}$ (Exposed Pad Soldered Down)	36.8°C/W
$\theta_{JC}$ (Exposed Pad is the Contact)	6.9°C/W
Maximum Junction Temperature	150°C
Lead Temperature (Soldering, 60 sec)	240°C
Operating Temperature Range	-40°C to +85°C
Storage Temperature Range	-65°C to +150°C

Stresses above those listed under Absolute Maximum Ratings may cause permanent damage to the device. This is a stress rating only; functional operation of the device at these or any other conditions above those indicated in the operational section of this specification is not implied. Exposure to absolute maximum rating conditions for extended periods may affect device reliability.

### ESD CAUTION



**ESD (electrostatic discharge) sensitive device.** Charged devices and circuit boards can discharge without detection. Although this product features patented or proprietary protection circuitry, damage may occur on devices subjected to high energy ESD. Therefore, proper ESD precautions should be taken to avoid performance degradation or loss of functionality.



# PIN CONFIGURATION AND FUNCTION DESCRIPTIONS

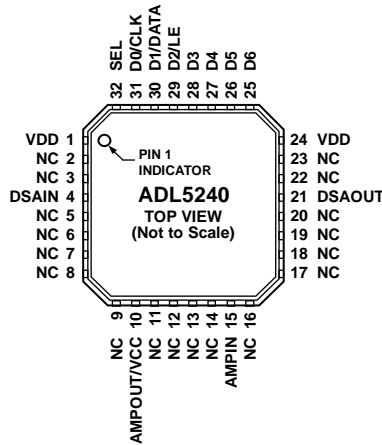

NOTES  
 1. NC = NO CONNECT. DO NOT CONNECT TO THIS PIN.  
 2. THE EXPOSED PAD MUST BE CONNECTED TO GROUND.

09430-002

Figure 2. Pin Configuration

Table 3. Pin Function Descriptions

Pin No.	Mnemonic	Description
1, 24	VDD	Supply Voltage for DSA. Connect this pin to a 5 V supply.
2, 3, 5, 6, 7, 8, 9, 11, 12, 13, 14, 16, 17, 18, 19, 20, 22, 23	NC	No Connect. Do not connect to this pin.
4	DSAIN	RF Input to DSA.
10	AMPOUT/VCC	RF Output from Amplifier/Supply Voltage for Amplifier. A bias to the amplifier is provided through a choke inductor connected to this pin.
15	AMPIN	RF Input to Amplifier.
21	DSAOUT	RF Output from DSA.
25	D6	Data Bit in Parallel Mode (LSB). Connect this pin to the supply in serial mode.
26	D5	Data Bit in Parallel Mode. Connect this pin to ground or leave open in serial mode.
27	D4	Data Bit in Parallel Mode. Connect this pin to ground or leave open in serial mode.
28	D3	Data Bit in Parallel Mode. Connect this pin to ground or leave open in serial mode.
29	D2/LE	Data Bit in Parallel Mode/Latch Enable in Serial Mode.
30	D1/DATA	Data Bit in Parallel Mode (MSB)/Data in Serial Mode.
31	D0/CLK	Connect this pin to ground in parallel mode. This pin functions as a clock in serial mode.
32	SEL	Select Pin. Connect this pin to the supply to select parallel mode operation; connect this pin to ground to select serial mode operation.
	EPAD	Exposed Pad. The exposed pad must be connected to ground.

TYPICAL PERFORMANCE CHARACTERISTICS

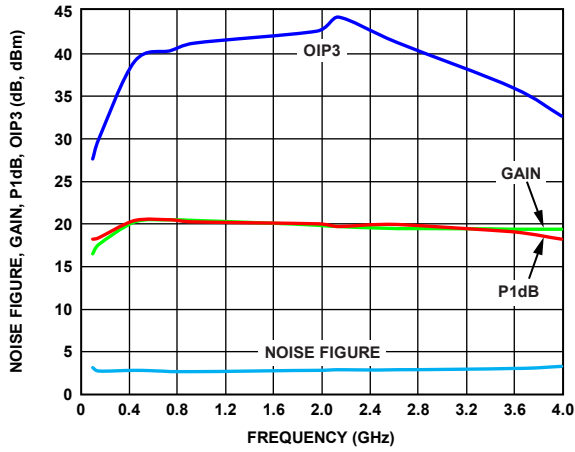

Figure 3. AMP: Gain, P1dB, OIP3 at  $P_{OUT} = 4$  dBm/Tone and Noise Figure vs. Frequency

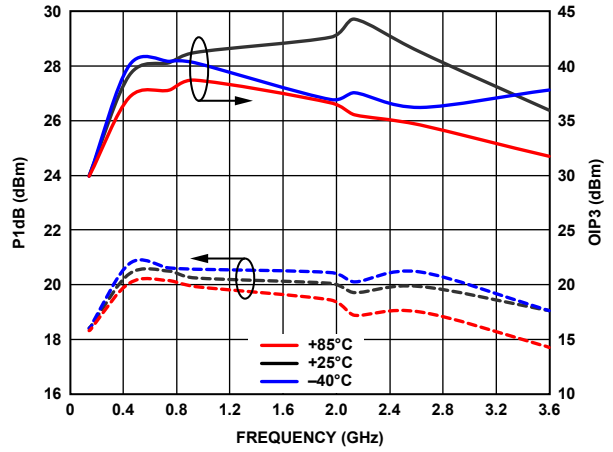

Figure 6. AMP: OIP3 at  $P_{OUT} = 4$  dBm/Tone and P1dB vs. Frequency and Temperature

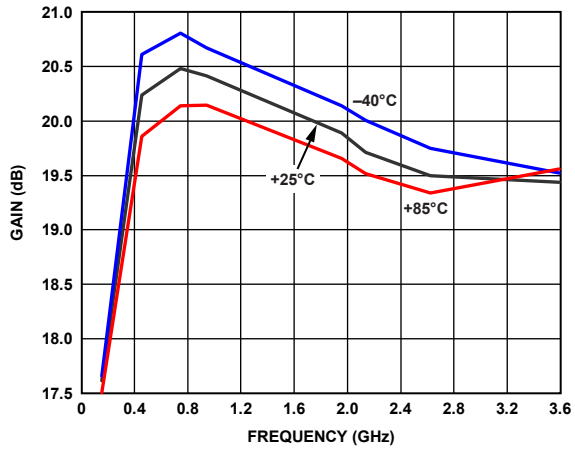

Figure 4. AMP: Gain vs. Frequency and Temperature

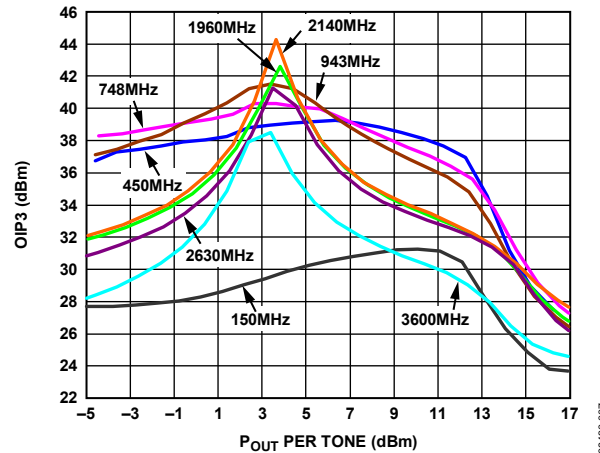

Figure 7. AMP: OIP3 vs.  $P_{OUT}$  and Frequency

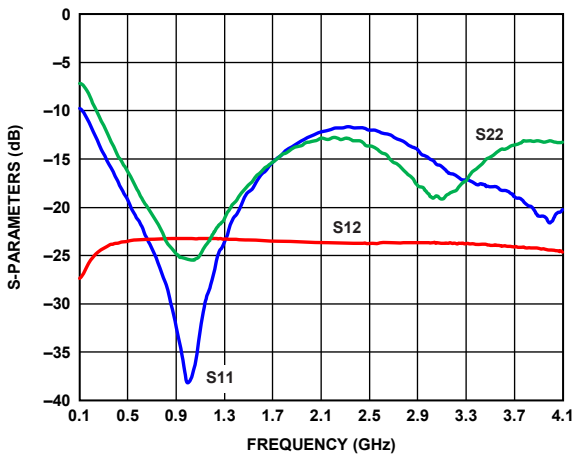

Figure 5. AMP: Input Return Loss (S11), Output Return Loss (S22), and Reverse Isolation (S12) vs. Frequency

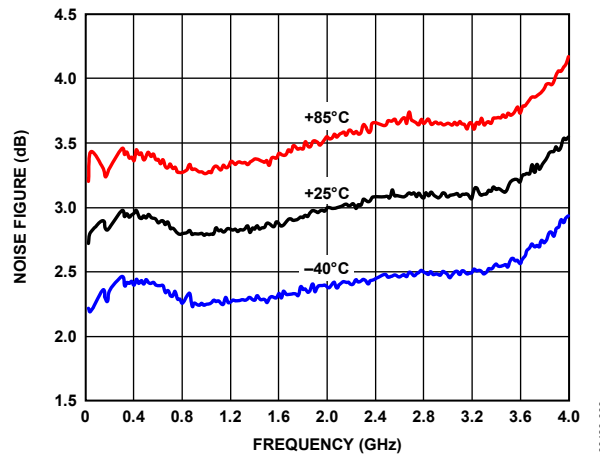

Figure 8. AMP: Noise Figure vs. Frequency and Temperature

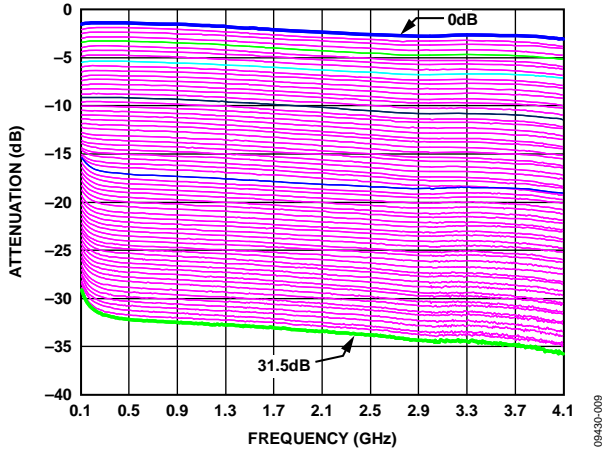

Figure 9. DSA: Attenuation vs. Frequency

08430-009

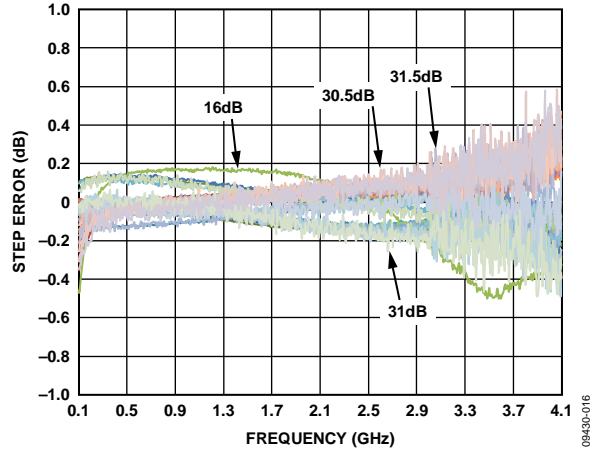

Figure 12. DSA: Step Error vs. Frequency, All Attenuation States

08430-016

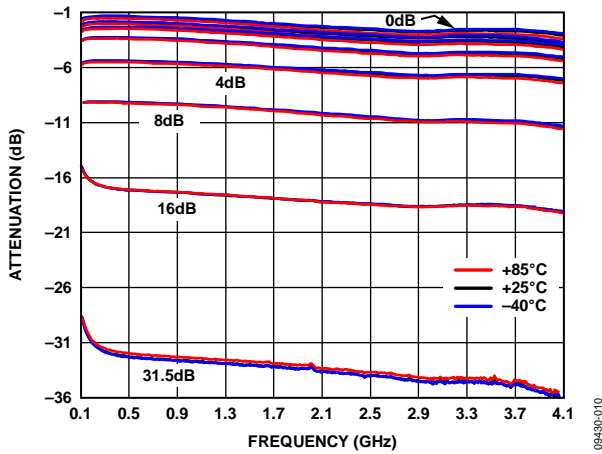

Figure 10. DSA: Attenuation vs. Frequency and Temperature

08430-010

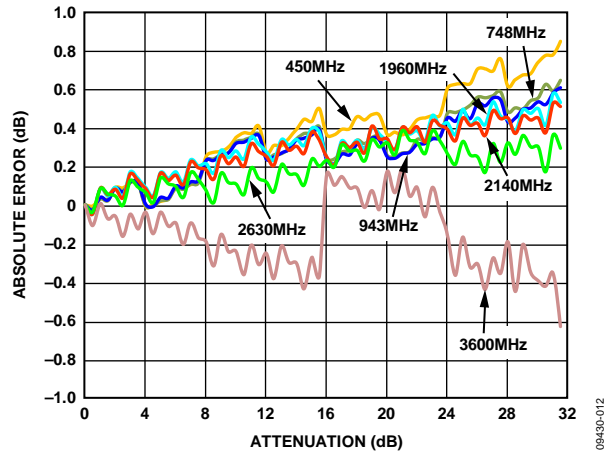

Figure 13. DSA: Absolute Error vs. Attenuation

08430-012

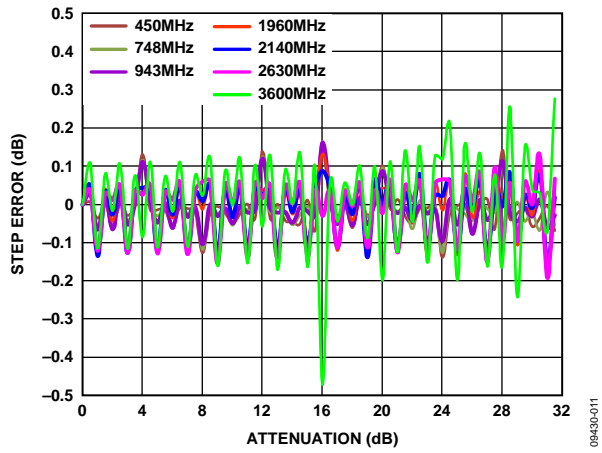

Figure 11. DSA: Step Error vs. Attenuation

08430-011

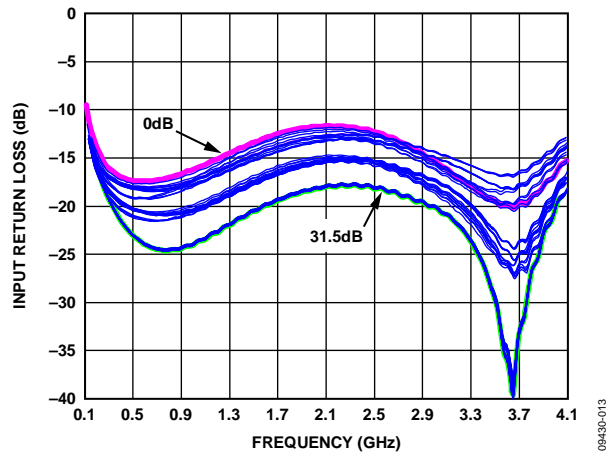

Figure 14. DSA: Input Return Loss vs. Frequency, All States

08430-013

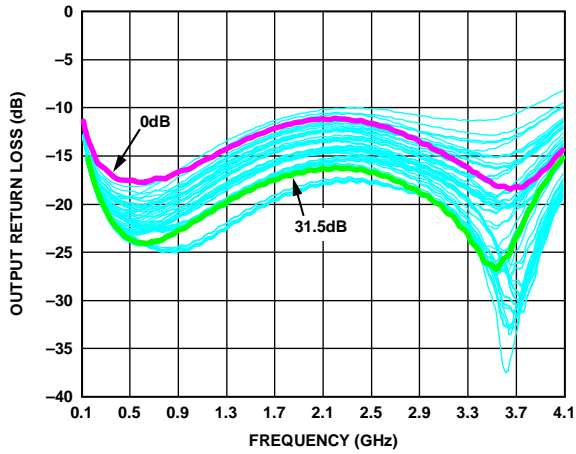

Figure 15. DSA: Output Return Loss vs. Frequency, All States

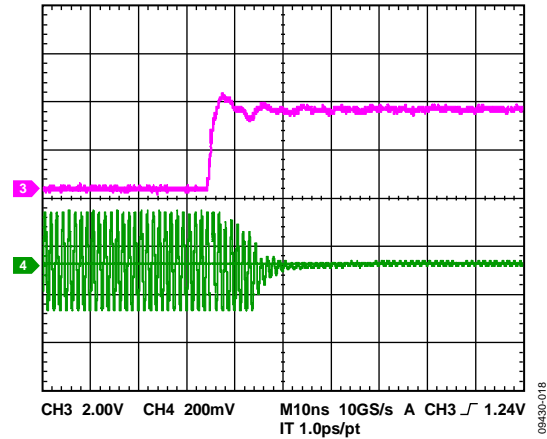

Figure 18. DSA: Gain Settling Time, 0 dB to 31.5 dB

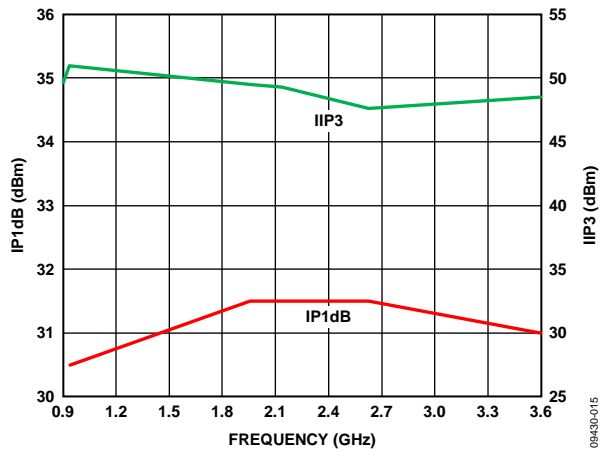

Figure 16. DSA: Input P1dB and Input IP3 vs. Frequency, Minimum Attenuation State

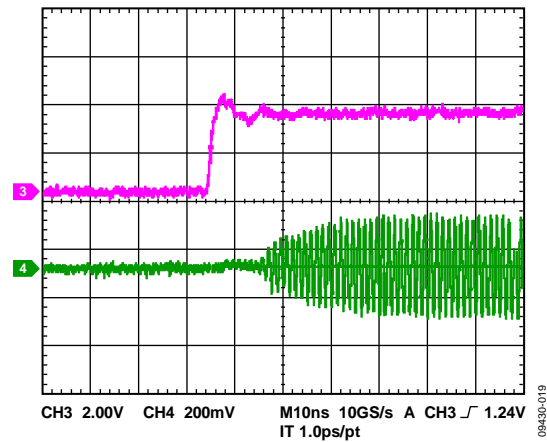

Figure 19. DSA: Gain Settling Time, 31.5 dB to 0 dB

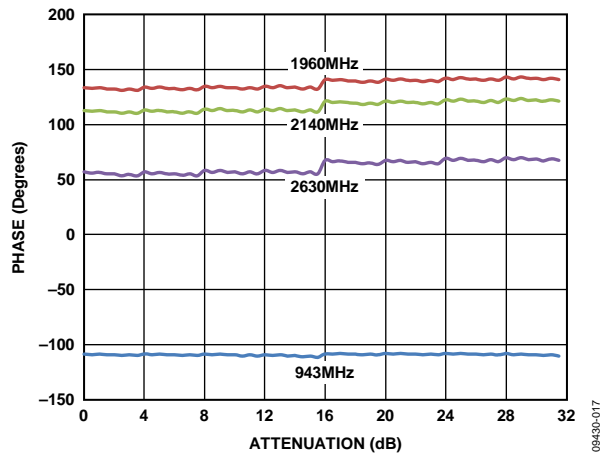

Figure 17. DSA: Phase vs. Attenuation

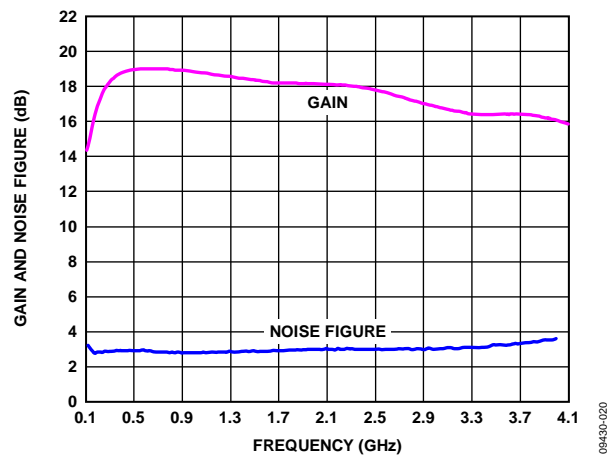

Figure 20. AMP-DSA Loop: Gain and Noise Figure vs. Frequency, Minimum Attenuation State

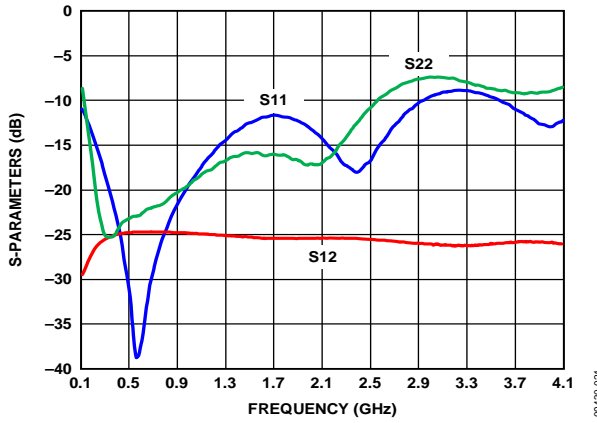

Figure 21. AMP-DSA Loop: Input Return Loss (S11), Output Return Loss (S22), and Reverse Isolation (S12) vs. Frequency, Minimum Attenuation State

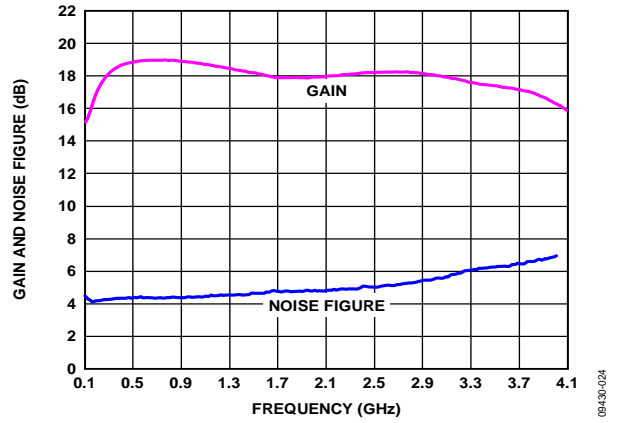

Figure 24. DSA-AMP Loop: Gain and Noise Figure vs. Frequency, Minimum Attenuation State

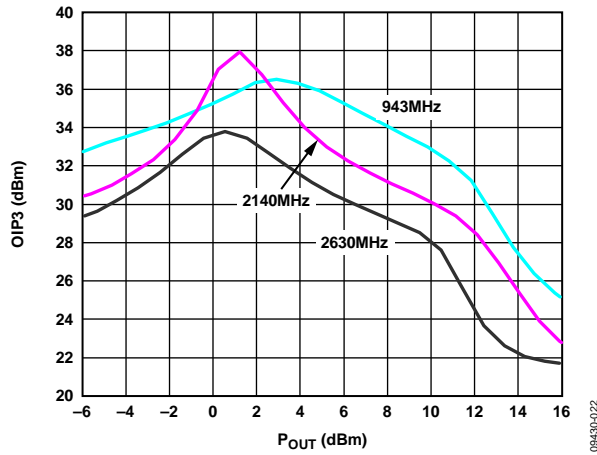

Figure 22. AMP-DSA Loop: OIP3 vs.  $P_{OUT}$  and Frequency, Minimum Attenuation State

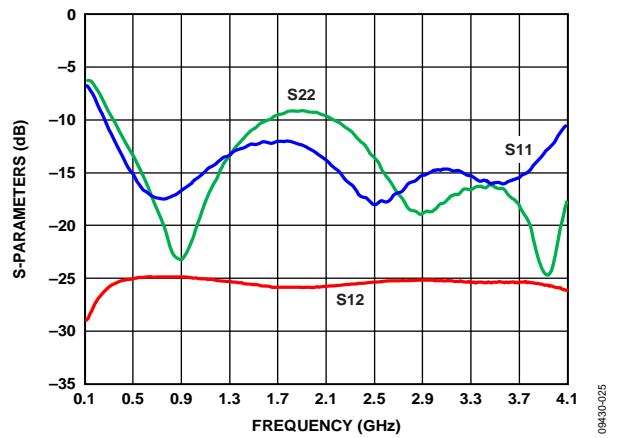

Figure 25. DSA-AMP Loop: Input Return Loss (S11), Output Return Loss (S22), and Reverse Isolation (S12) vs. Frequency, Minimum Attenuation State

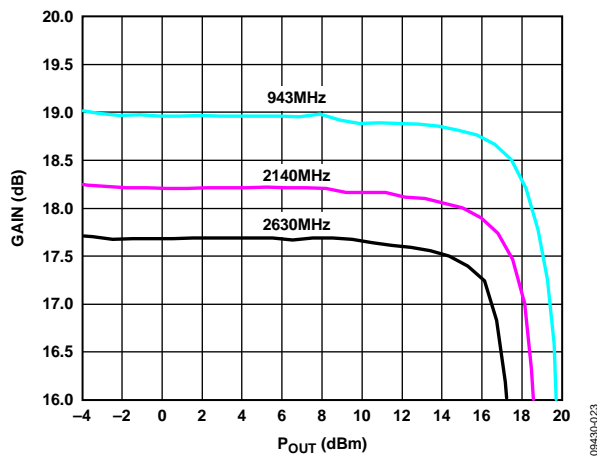

Figure 23. AMP-DSA Loop: Gain vs.  $P_{OUT}$  and Frequency, Minimum Attenuation State

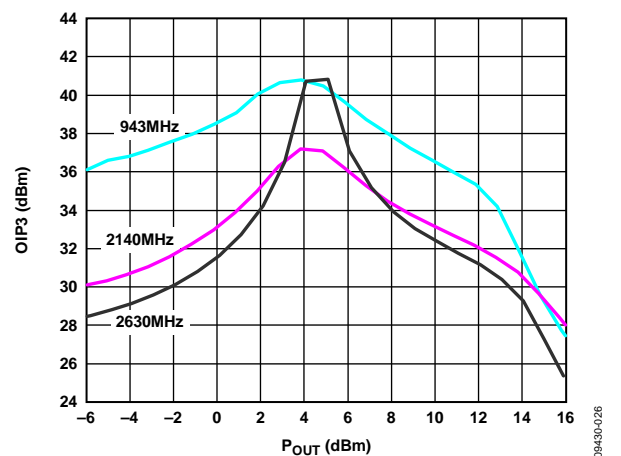

Figure 26. DSA-AMP Loop: OIP3 vs.  $P_{OUT}$  and Frequency, Minimum Attenuation State

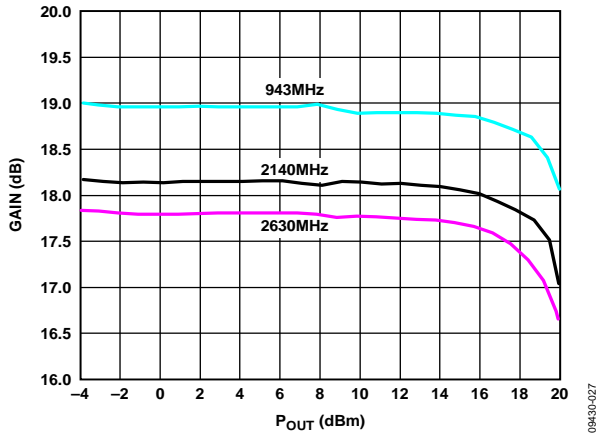

Figure 27. DSA-AMP Loop: Gain vs. P<sub>OUT</sub> and Frequency, Minimum Attenuation State

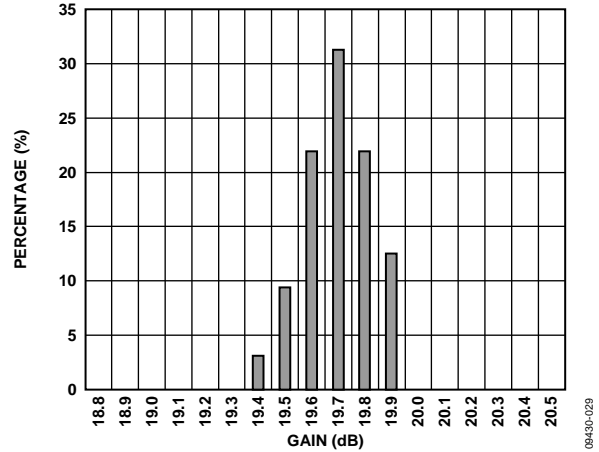

Figure 30. AMP: Gain Distribution at 2140 MHz

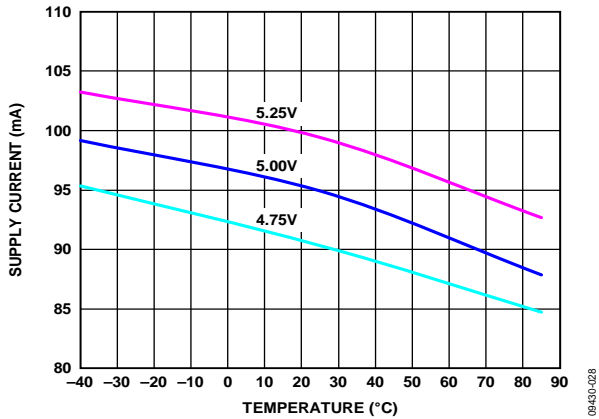

Figure 28. AMP: Supply Current vs. Voltage and Temperature

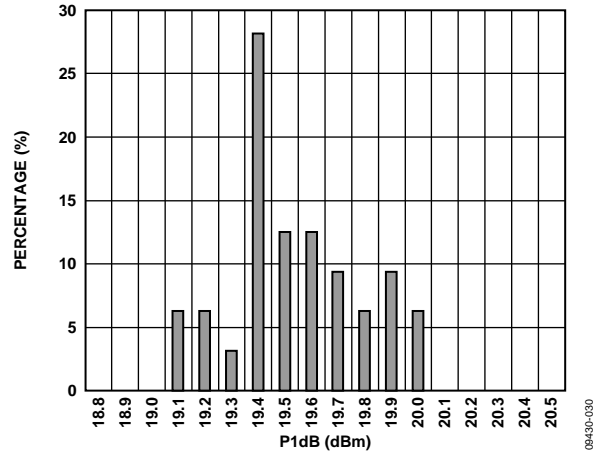

Figure 31. AMP: P1dB Distribution at 2140 MHz

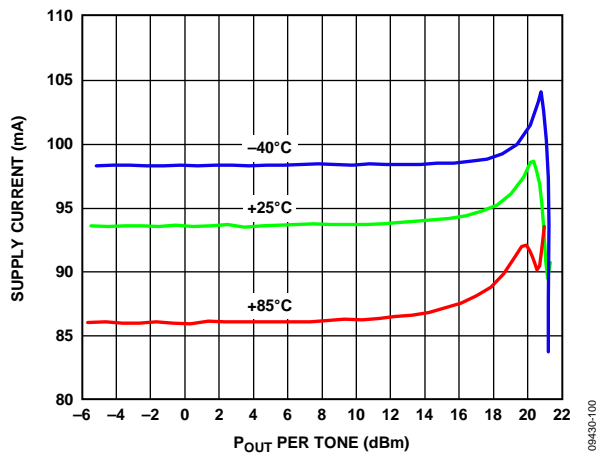

Figure 29. AMP: Supply Current vs. P<sub>OUT</sub> and Temperature

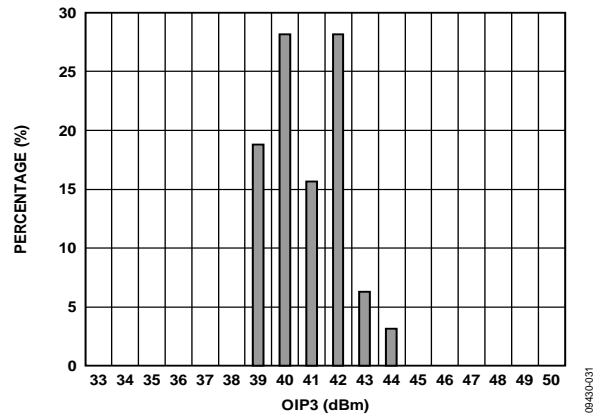

Figure 32. AMP: OIP3 Distribution at 2140 MHz

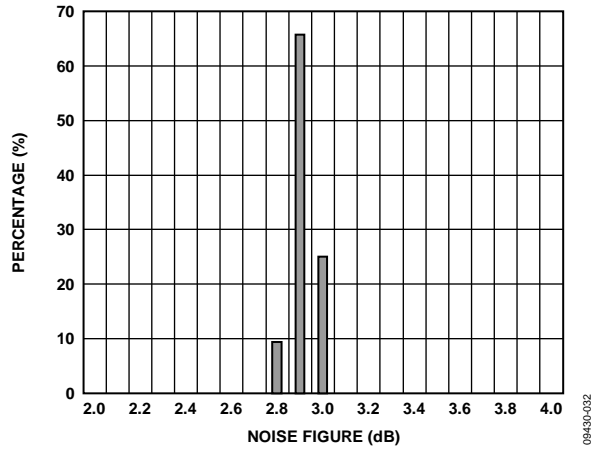

Figure 33. AMP: Noise Figure Distribution at 2140 MHz

# APPLICATIONS INFORMATION

## BASIC LAYOUT CONNECTIONS

The basic connections for operating the [ADL5240](#) are shown in Figure 34.

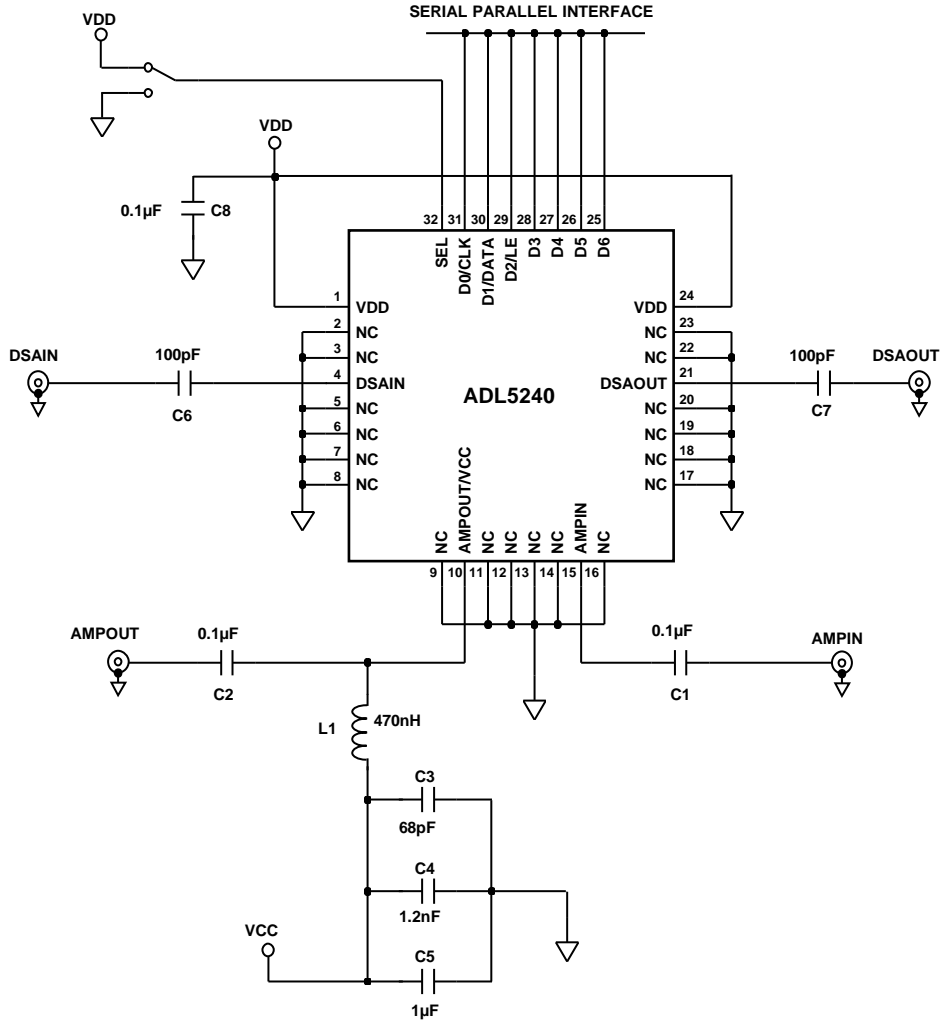

Figure 34. Basic Connections

09430-033



**Amplifier Bias**

The dc bias for the amplifier in [ADL5240](#) is supplied through Inductor L1 and is connected to the AMPOUT pin. Three decoupling capacitors (C3, C4, and C5) are used to prevent RF signals from propagating onto the dc lines. The dc supply ranges from 4.75 V to 5.25 V and should be connected to the VCC test point on the evaluation board.

**Digital Step Attenuator Bias**

The bias for the DSA is provided through the VDD pin. At least one decoupling capacitor (C8) is recommended on the VDD trace. The voltage ranges from 4.75 V to 5.25 V and should be connected to the VDD test point on the evaluation board. The DSA is shown to work for dc voltages as low as 2.5 V.

**Amplifier RF Input Interface**

Pin 15 is the RF input for the amplifier of [ADL5240](#). The amplifier is internally matched to 50  $\Omega$  at the input; therefore, no external components are required. Only a dc blocking capacitor (C1) is required.

**Amplifier RF Output Interface**

Pin 10 is the RF output for the amplifier of [ADL5240](#). The amplifier is internally matched to 50  $\Omega$  at the output; therefore, no external components are required. Only a dc blocking capacitor (C2) is required. The bias is provided through this pin via a choke inductor.

**DSA RF Input Interface**

Pin 4 is the RF input for the DSA of [ADL5240](#). The input impedance of the DSA is close to 50  $\Omega$  over the entire frequency range; therefore, no external components are required. Only a dc blocking capacitor (C6) is required.

**DSA RF Output Interface**

Pin 21 is the RF output for the DSA of [ADL5240](#). The output impedance of the DSA is close to 50  $\Omega$  over the entire frequency range; therefore, no external components are required. Only a dc blocking capacitor (C7) is required.

**DSA SPI Interface**

The DSA of the [ADL5240](#) can operate in either serial or parallel mode. Pin 32 (SEL) controls the mode of operation. To select serial mode, connect SEL to ground; to select parallel mode, connect SEL to VDD. In parallel mode, Pin 25 to Pin 30 (D6 to D1) are the data bits, with D6 being the LSB. Connect Pin 31 (D0) to ground during the parallel mode of operation. In serial mode, Pin 29 is the latch enable (LE), Pin 30 is the data (DATA), and Pin 31 is the clock (CLK). Pin 26, Pin 27, and Pin 28 are not used in serial mode and should be connected to ground. Pin 25 (D6) should be connected to VDD during the serial mode of operation. To prevent noise from coupling onto the digital signals, an RC filter can be used on each data line.

**SPI TIMING**

Table 5 provides details about the timing characteristics for the SPI signals—namely, the clock (CLK), latch enable (LE), and data (DATA) signals—and Figure 35 shows the corresponding SPI timing diagram.

**SPI Timing Sequence**

Figure 36 is the timing sequence for the SPI function using a 6-bit operation. The clock can be as fast as 20 MHz. In serial mode, Register B5 (MSB) is first and Register B0 (LSB) is last.

**Table 4. Mode Selection Table**

Pin 32 (SEL)	Functionality
Connect to Ground	Serial mode
Connect to Supply	Parallel mode

**Table 5. SPI Timing Setup**

Parameter	Limit	Unit	Test Conditions/Comments
$f_{CLK}$	10	MHz	Data clock frequency
$t_1$	25	ns min	Clock high time
$t_2$	25	ns min	Clock low time
$t_3$	10	ns min	Data to clock setup time
$t_4$	10	ns min	Clock to data hold time
$t_5$	10	ns min	Clock low to LE setup time
$t_6$	30	ns min	LE pulse width

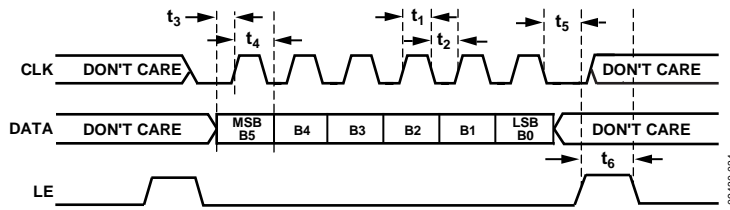

Figure 35. SPI Timing Diagram (Data Is Loaded MSB First), Serial Mode

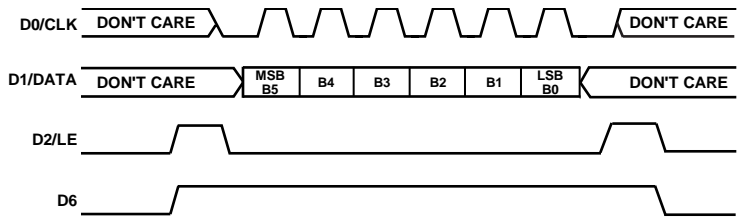

Figure 36. SPI Timing Sequence, Serial Mode

Table 6. DSA Attenuation Truth Table—Serial Mode

Attenuation State (dB)	B5 (MSB)	B4	B3	B2	B1	B0 (LSB)
0 (Reference)	1	1	1	1	1	1
0.5	1	1	1	1	1	0
1.0	1	1	1	1	0	1
2.0	1	1	1	0	1	1
4.0	1	1	0	1	1	1
8.0	1	0	1	1	1	1
16.0	0	1	1	1	1	1
31.5	0	0	0	0	0	0

Table 7. DSA Attenuation Truth Table—Parallel Mode

Attenuation State (dB)	D1 (MSB)	D2	D3	D4	D5	D6 (LSB)
0 (Reference)	1	1	1	1	1	1
0.5	1	1	1	1	1	0
1.0	1	1	1	1	0	1
2.0	1	1	1	0	1	1
4.0	1	1	0	1	1	1
8.0	1	0	1	1	1	1
16.0	0	1	1	1	1	1
31.5	0	0	0	0	0	0

**LOOP PERFORMANCE**

The ADL5240 can be configured so that either the DSA precedes the amplifier (see Figure 37) or the amplifier precedes the DSA (see Figure 38). The performance of the loop configurations is presented in Figure 20 to Figure 27. To improve the overall return loss, a shunt capacitor can be placed between the amplifier and DSA. This helps to align the phases of the two blocks.

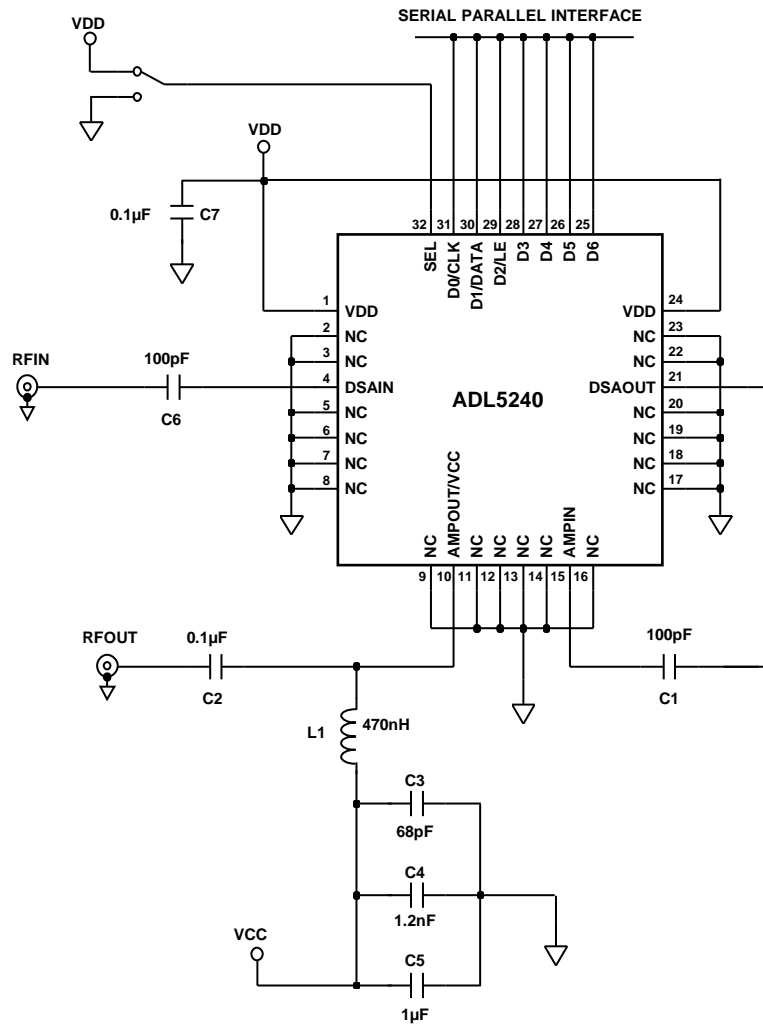

Figure 37. DSA-AMP Loop Configuration

09430-008

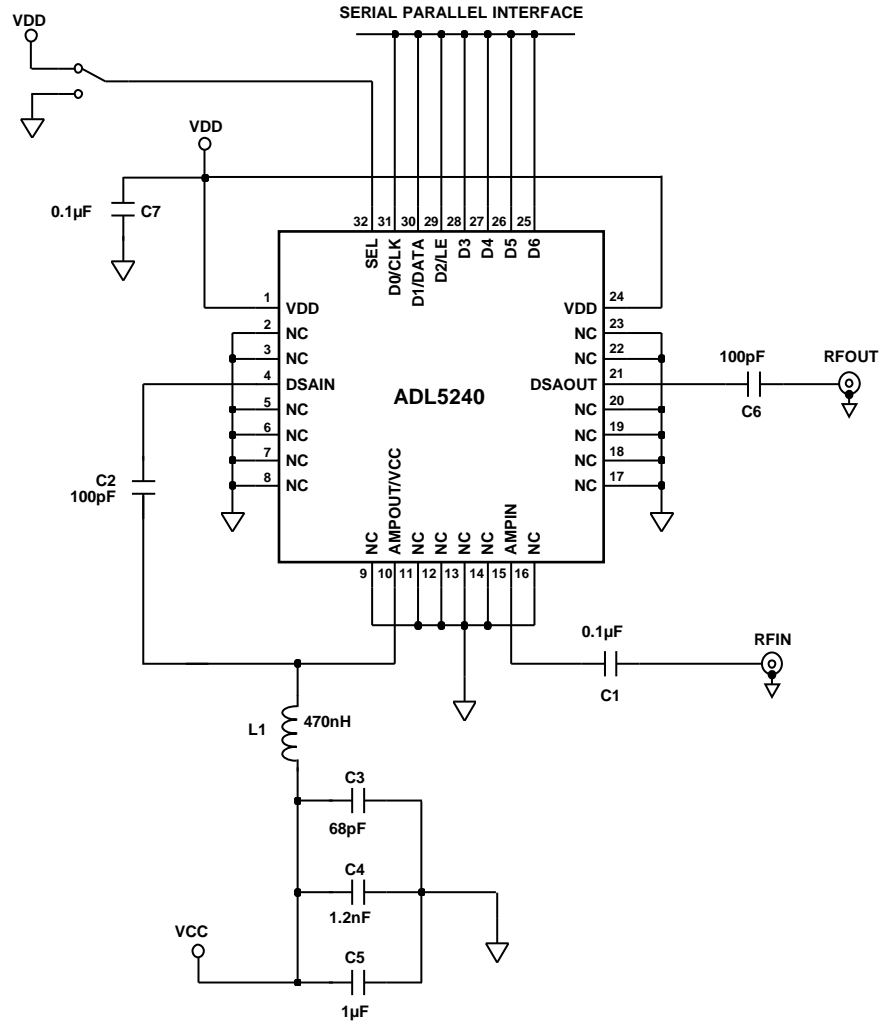

Figure 38. AMP-DSA Loop Configuration

09430-037

**AMPLIFIER DRIVE LEVEL FOR OPTIMUM ACLR**

It is usually required to drive the amplifier as high as possible in order to maximize output power. However, properly driving Amplifier at the ADL5240 is required to achieve optimum ACLR performance. Once output power approaches P1dB and OIP3, there is ACLR degradation. The driving level of amplifier with a modulated signal should be backed off properly from P1dB by at least the amount of a signal crest factor for optimum ACLR. So assuming a gain and output P1dB of Amplifier at 2140 MHz are 19 dB and 19 dBm respectively, the output power, which is backed off by 11 dB crest factor at the modulated signal case, is 8 dBm. Therefore, the proper input driving level should be under -11 dBm.

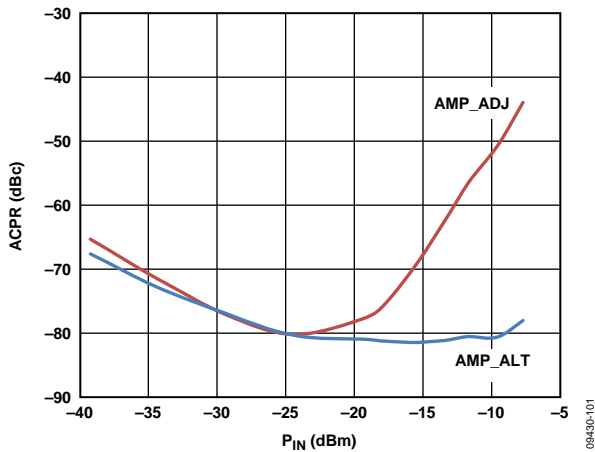

Figure 39. Single Carrier WCDMA Adjacent Channel Power Ratio vs. Input Power at Amplifier, 2140 MHz

**THERMAL CONSIDERATIONS**

The ADL5240 is packaged in a thermally efficient, 5 mm × 5 mm, 32-lead LFCSP. The thermal resistance from junction to air ( $\theta_{JA}$ ) is 36.8°C/W. The thermal resistance for the product was extracted assuming a standard 4-layer JEDEC board with 25 conductive, epoxy filled thermal vias. The thermal resistance from junction to case ( $\theta_{JC}$ ) is 6.9°C/W, where case is the exposed pad of the lead frame package.

The ADL5240 consumes approximately 93 mA with a 5 V supply voltage. Even though the part dissipates less than 0.5 W, for the best thermal performance, it is recommended to add as many thermal vias as possible under the exposed pad of the LFCSP. The thermal resistance values given in this section assume a minimum of 25 thermal vias arranged in a 5 × 5 array with a diameter of 13 mils and a pitch of 25 mils. Figure 40 shows a close-up of the thermal via distribution under the exposed pad.

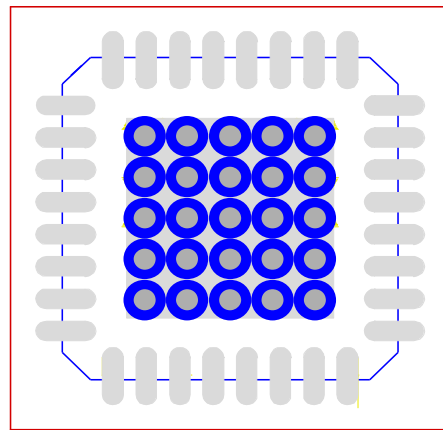

Figure 40. Exposed Pad with Thermal Via Distribution

## EVALUATION BOARD

The schematic of the [ADL5240](#) evaluation board is shown in Figure 41, the evaluation board configuration options are detailed in Table 8, and the layout of the [ADL5240](#) evaluation board is shown in Figure 43 and Figure 44. Each RF trace on the evaluation board has a characteristic impedance of  $50\ \Omega$  and is fabricated on Rogers3003 material. In addition, each trace is a coplanar waveguide (CPWG) with a width of 25 mils, a spacing of 20 mils, and a dielectric thickness of 10 mils. The input to and output from the DSA and amplifier should be ac-coupled with capacitors of appropriate values to ensure the broadband performance. The bias to the amplifier is provided by connecting a choke to the AMPOUT pin. Bypassing capacitors are recommended on all supply lines to minimize the RF coupling. The DSA and the amplifier can be individually biased or connected to the VDD plane using Resistors R2 and R1.

The [ADL5240](#) can be operated in two ways: the amplifier can precede the DSA (AMP-DSA loop configuration) or the DSA can precede the amplifier (DSA-AMP loop configuration). The evaluation board can be configured to handle either option. In normal operation, R12 and R13 are open, and R10 and R11 are  $0\ \Omega$  and are used to terminate any RF coupling onto the bypass trace. To configure the [ADL5240](#) in AMP-DSA loop configuration, R12 should be replaced with a capacitor, R13 should be replaced with a  $0\ \Omega$  resistor, and R10 and R11 should be left open. Similarly, to configure the [ADL5240](#) in the DSA-AMP loop configuration, R16 should be replaced with a capacitor, R17 should be replaced with a  $0\ \Omega$  resistor, and R14 and R15 should be left open.

The digital signal traces incorporate a footprint for an RC filter to prevent potential noise from coupling onto the signal. In normal operation, series resistors are  $0\ \Omega$  and shunt resistors and capacitors are open.

The evaluation board is designed to control DSA in either parallel or serial mode by connecting the SEL pin to the supply or ground by a switch.

For adjusting attenuation at DSA, the [ADL5240](#) can be programmed in two ways: through the on-board USB interface from a PC USB port, or through an SDP board, which will become the Analog Devices common control board in the future. The on-board USB interface circuitry of the evaluation board is powered directly by the PC. USB based programming software is available to download from the [ADL5240](#) product page at [www.analog.com](http://www.analog.com). Figure 45 shows the window of the programming software where the user selects serial or parallel mode for the attenuation adjustment at DSA. The selection of the mode in the window should match the mode of the evaluation board switch.

It is highly recommended to refer the evaluation board layout for the optimal and stable performance of each block as well as for the improvement of thermal efficiency.





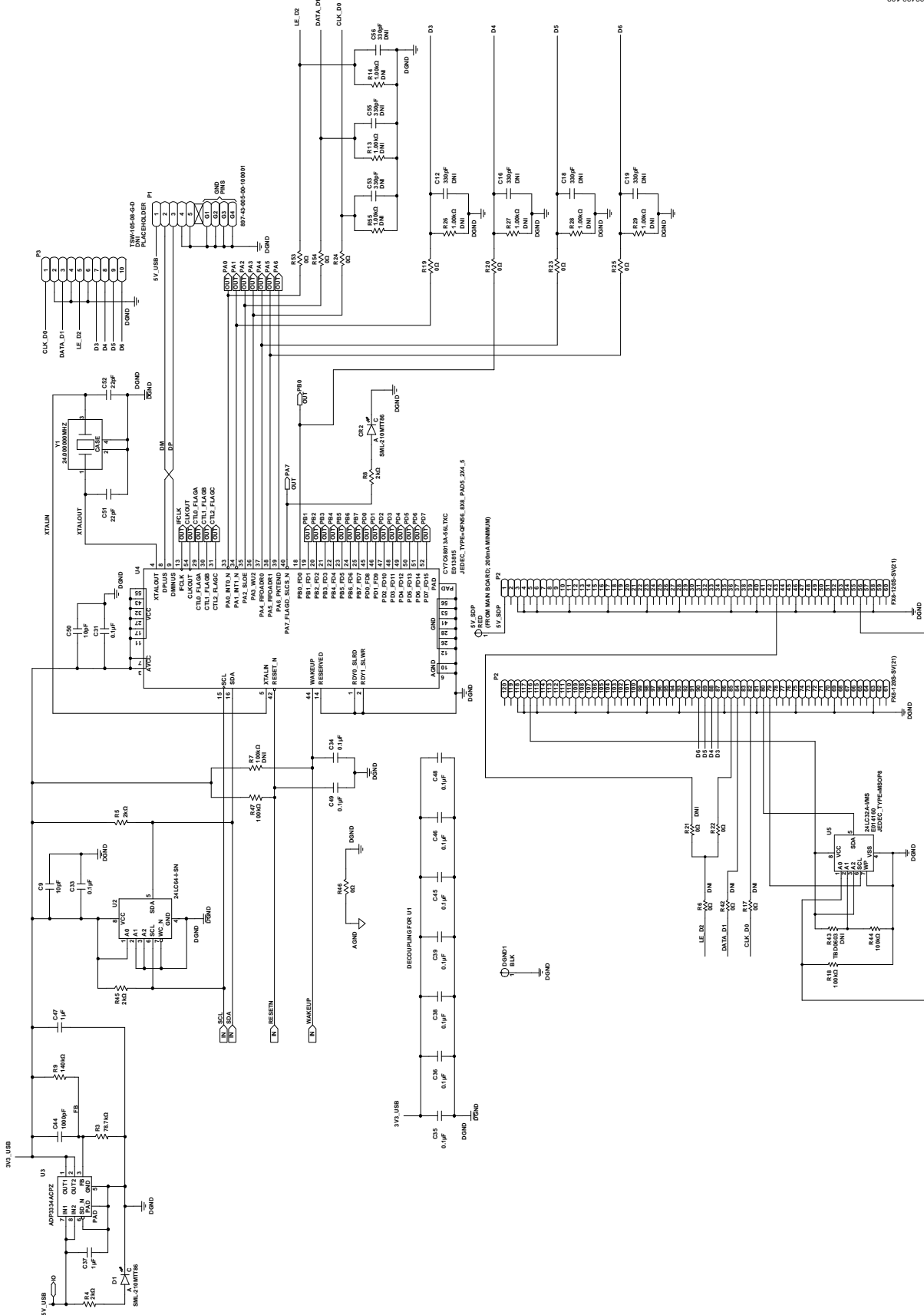

Figure 42. USB/SDP Interface Circuitry on the Customer Evaluation Board

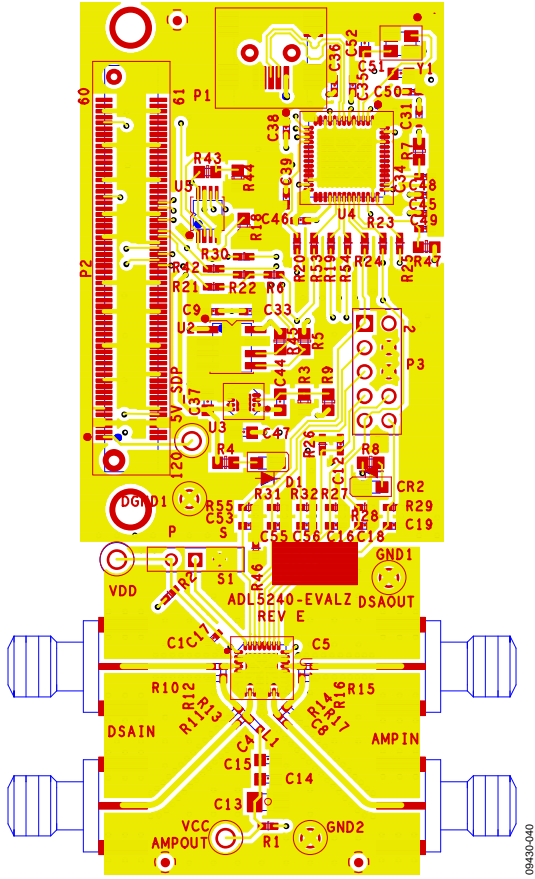

Figure 43. Evaluation Board Layout—Top

09430-040

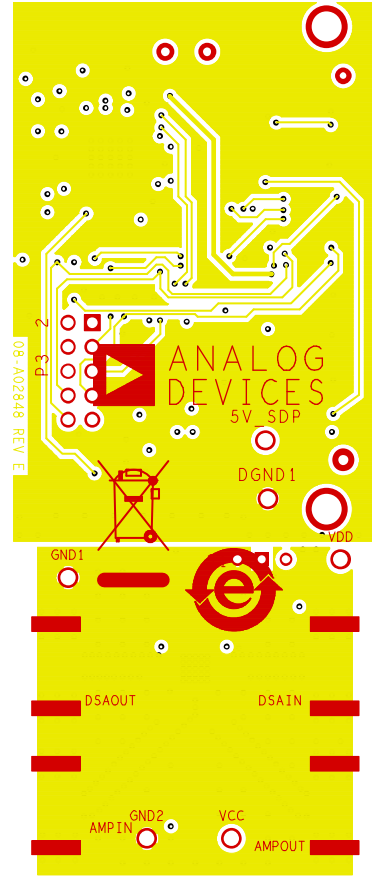

Figure 44. Evaluation Board Layout—Bottom

09430-040

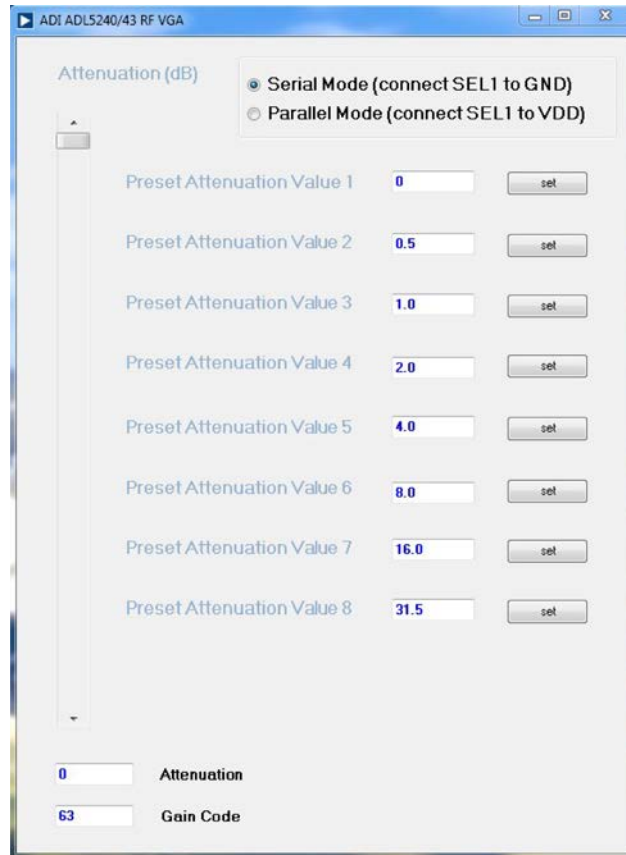
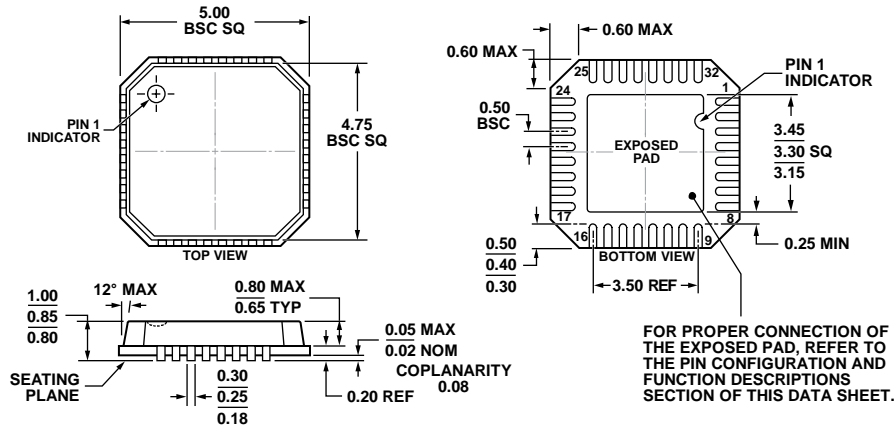

Figure 45. Evaluation Board Control Software

OUTLINE DIMENSIONS



COMPLIANT TO JEDEC STANDARDS MO-220-VHDD-2  
 Figure 46. 32-Lead Lead Frame Chip Scale Package [LFCSP\_VQ]  
 5 mm × 5 mm Body, Very Thin Quad  
 (CP-32-3)  
 Dimensions shown in millimeters

05-23-2012-A

ORDERING GUIDE

Model <sup>1</sup>	Temperature Range	Package Description	Package Option
ADL5240ACPZ-R7	-40°C to +85°C	32 Lead LFCSP_VQ, 7" Tape and Reel	CP-32-3
ADL5240-EVALZ		Evaluation Board	

<sup>1</sup> Z = RoHS Compliant Part.