

NLX1G99

Configurable Multifunction Gate

The NLX1G99 MiniGate™ is an advanced high-speed CMOS multifunction gate with a 3-state output. With the output enable input (\overline{OE}) at High, the output is disabled and is kept at high impedance. With the output enable input (\overline{OE}) at Low, the device can be configured for logic functions such as MUX, AND, OR, NAND, NOR, XOR, XNOR, INVERT and BUFFER, depending on the combination of the 4-bit input. The device has Schmitt-trigger inputs, thereby enhancing noise immunity.

The NLX1G99 input and output structures provide protection when voltages up to 7.0 V are applied, regardless of the supply voltage.

Features

- High Speed: $t_{PD} = 6.7$ ns (Max) @ $V_{CC} = 3.3$ V
- Low Power Dissipation: $I_{CC} = 1$ μ A (Max) at $T_A = 25^\circ$ C
- Power Down Protection Provided on inputs
- Balanced Propagation Delays
- Overvoltage Tolerant (OVT) Input and Output Pins
- Ultra-Small Packages
- These Devices are Pb-Free, Halogen Free/BFR Free and are RoHS Compliant

PIN ASSIGNMENT

| | |
|---|-----------------|
| 1 | \overline{OE} |
| 2 | A |
| 3 | B |
| 4 | GND |
| 5 | C |
| 6 | D |
| 7 | Y |
| 8 | V_{CC} |

PIN ASSIGNMENTS

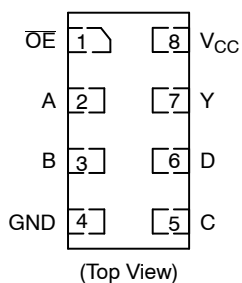

ON Semiconductor®

www.onsemi.com

MARKING DIAGRAMS



UDFN8
1.45 x 1.0
CASE 517BZ

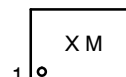

UDFN8
1.6 x 1.0
CASE 517BY

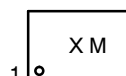

UDFN8
1.95 x 1.0
CASE 517CA

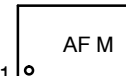

AA or E = Specific Device Code

M = Date Code

▪ = Pb-Free Package

ORDERING INFORMATION

See detailed ordering and shipping information in the package dimensions section on page 12 of this data sheet.

NLX1G99

FUNCTION DIAGRAM

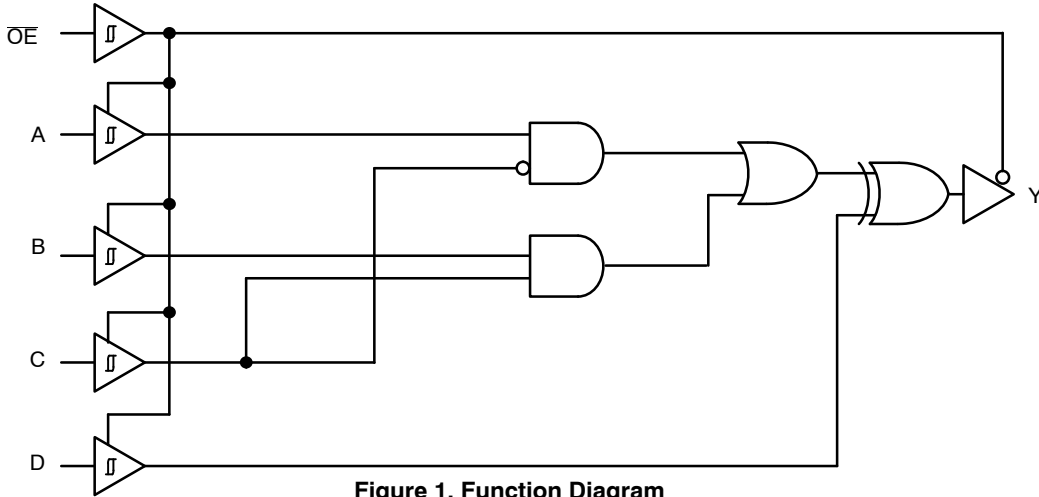

Figure 1. Function Diagram

FUNCTION TABLE*

| INPUT | | | | | OUTPUT |
|-------|--------|--------|--------|--------|--------|
| OE | D | C | B | A | Y |
| L | L | L | L | L | L |
| L | L | L | L | H | H |
| L | L | L | H | L | L |
| L | L | L | H | H | H |
| L | L | H | L | L | L |
| L | L | H | L | H | L |
| L | L | H | H | L | H |
| L | L | H | H | H | H |
| L | H | L | L | L | H |
| L | H | L | L | H | L |
| L | H | L | H | L | H |
| L | H | L | H | H | L |
| L | H | H | L | L | H |
| L | H | H | L | H | H |
| L | H | H | H | L | L |
| L | H | H | H | H | L |
| H | H or L | H or L | H or L | H or L | Z |

*To select a logic function, please refer to "Logic Configurations" section.

| FUNCTION SELECTION | LOGIC CONFIGURATION PAGE |
|------------------------|--------------------------|
| 3-State Buffers | 3 |
| 3-State Inverters | 3 |
| 3-State MUXes | 3 |
| 3-State AND / OR / NOR | 4 |
| 3-State NAND / OR | 5 |
| 3-State XOR/XNOR | 6 |

NLX1G99

LOGIC CONFIGURATIONS

3-State Buffer Functions Available

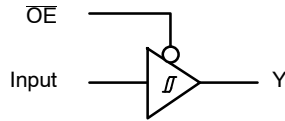

Figure 2.

| Function | \overline{OE} | A | B | C | D |
|----------------|-----------------|---|---|--|---|
| 3-State Buffer | L | Input H or L L H H H or L L | H or L Input H L H or L L L | L H Input Input L H H or L | L L L H Input Input Input |

3-State Inverter Functions Available

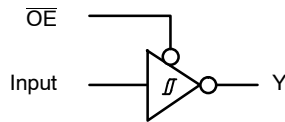

Figure 3.

| Function | \overline{OE} | A | B | C | D |
|----------------|-----------------|--|---|--|---|
| 3-State Buffer | L | Input X L H H H or L H | H or L Input H L H or L H H | L H Input Input L H H or L | H H H L Input Input Input |

3-State MUX Functions Available

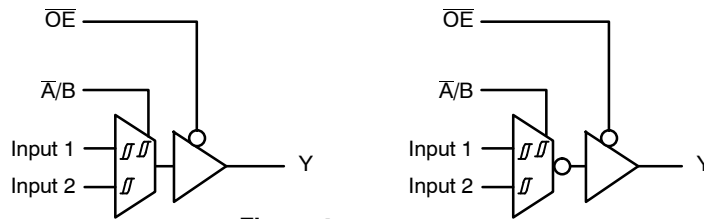

Figure 4.

| Function | \overline{OE} | A | B | C | D |
|------------------------------|-----------------|---------|---------|--|---|
| 3-State 2-to-1 | L | Input 1 | Input 2 | Input 1 or Input 2 | L |
| 3-State 2-to-1 | | Input 2 | Input 1 | $\overline{\text{Input 2}}$ or Input 1 | L |
| 3-State 2-to-1, Inverted Out | | Input 1 | Input 2 | $\overline{\text{Input 1}}$ or Input 2 | H |
| 3-State 2-to-1, Inverted Out | | Input 2 | Input 1 | $\overline{\text{Input 2}}$ or Input 1 | H |

NLX1G99

3-State AND/NOR/OR Function Available

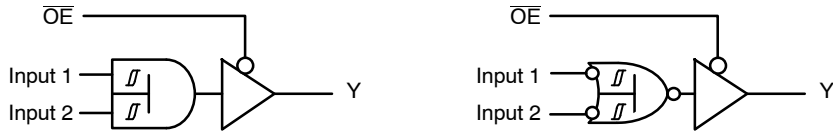

Figure 5.

| No. of Inputs | AND/NAND Function | OR/NOR Function | \overline{OE} | A | B | C | D |
|---------------|-------------------|-----------------|-----------------|---|---------|---------|---|
| 2 | 3-State AND | 3-State NOR | L | L | Input 1 | Input 2 | L |
| 2 | 3-State AND | 3-State NOR | | L | Input 2 | Input 1 | L |

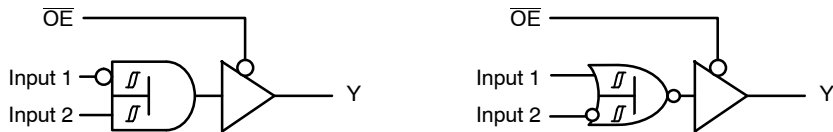

Figure 6.

| No. of Inputs | AND/NAND Function | OR/NOR Function | \overline{OE} | A | B | C | D |
|---------------|-------------------|-----------------|-----------------|---------|---------|---------|---|
| 2 | 3-State AND | 3-State NOR | L | Input 2 | L | Input 1 | L |
| 2 | 3-State AND | 3-State NOR | | H | Input 1 | Input 2 | H |

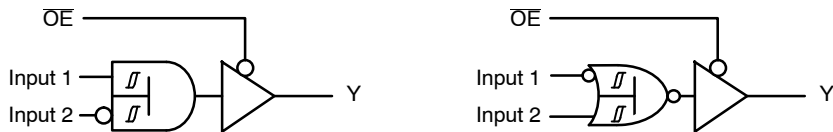

Figure 7.

| No. of Inputs | AND/NAND Function | OR/NOR Function | \overline{OE} | A | B | C | D |
|---------------|-------------------|-----------------|-----------------|---------|---------|---------|---|
| 2 | 3-State AND | 3-State NOR | L | Input 1 | L | Input 2 | L |
| 2 | 3-State AND | 3-State NOR | | H | Input 2 | Input 1 | H |

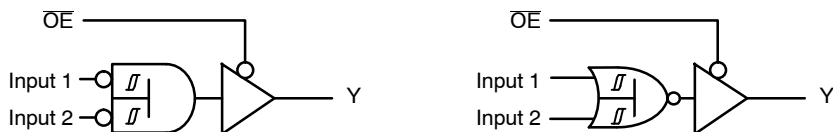

Figure 8.

| No. of Inputs | AND/NAND Function | OR/NOR Function | \overline{OE} | A | B | C | D |
|---------------|-------------------|-----------------|-----------------|---------|---|---------|---|
| 2 | 3-State AND | 3-State NOR | L | Input 1 | H | Input 2 | H |
| 2 | 3-State AND | 3-State NOR | | Input 2 | H | Input 1 | H |

NLX1G99

3-State NAND/OR Function Available

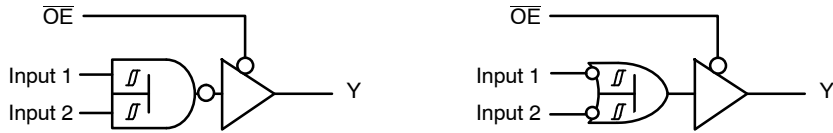

Figure 9.

| No. of Inputs | AND/NAND Function | OR/NOR Function | \overline{OE} | A | B | C | D |
|---------------|-------------------|-----------------|-----------------|---|---------|---------|---|
| 2 | 3-State NAND | 3-State OR | L | L | Input 1 | Input 2 | H |
| 2 | 3-State NAND | 3-State OR | | L | Input 2 | Input 1 | H |

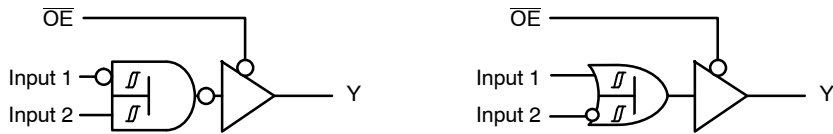

Figure 10.

| No. of Inputs | AND/NAND Function | OR/NOR Function | \overline{OE} | A | B | C | D |
|---------------|-------------------|-----------------|-----------------|---------|---------|---------|---|
| 2 | 3-State NAND | 3-State OR | L | Input 2 | L | Input 1 | H |
| 2 | 3-State NAND | 3-State OR | | H | Input 1 | Input 2 | L |

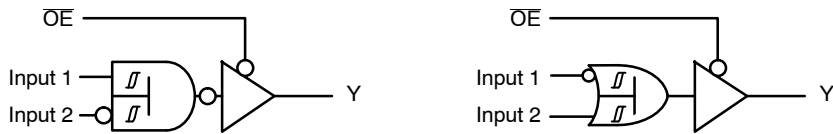

Figure 11.

| No. of Inputs | AND/NAND Function | OR/NOR Function | \overline{OE} | A | B | C | D |
|---------------|-------------------|-----------------|-----------------|---------|---------|---------|---|
| 2 | 3-State NAND | 3-State OR | L | Input 1 | L | Input 2 | H |
| 2 | 3-State NAND | 3-State OR | | H | Input 2 | Input 1 | L |



Figure 12.

| No. of Inputs | AND/NAND Function | OR/NOR Function | \overline{OE} | A | B | C | D |
|---------------|-------------------|-----------------|-----------------|---------|---|---------|---|
| 2 | 3-State AND | 3-State OR | L | Input 1 | H | Input 2 | L |
| 2 | 3-State AND | 3-State OR | | Input 2 | H | Input 1 | L |

NLX1G99

3-State XOR/XNOR Function Available

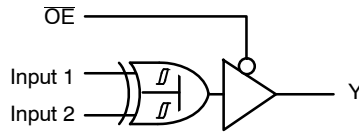

Figure 13.

| Function | \overline{OE} | A | B | C | D |
|-------------|-----------------|--|--|-----------------------------------|--|
| 3-State XOR | L | Input 1 Input 2 H or L H or L L L | H or L H or L Input 1 Input 2 H H | L L H Input 1 Input 2 | Input 2 Input 1 Input 2 Input 1 Input 2 Input 1 |

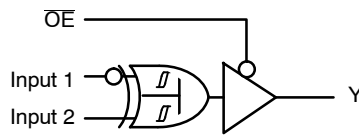

Figure 14.

| Function | \overline{OE} | A | B | C | D |
|-------------|-----------------|---|---|---------|---------|
| 3-State XOR | L | H | L | Input 1 | Input 2 |

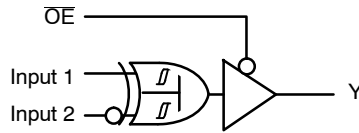

Figure 15.

| Function | \overline{OE} | A | B | C | D |
|-------------|-----------------|---|---|---------|---------|
| 3-State XOR | L | H | L | Input 1 | Input 2 |

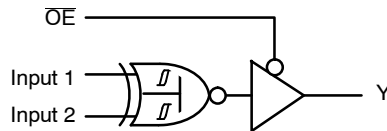

Figure 16.

| Function | \overline{OE} | A | B | C | D |
|--------------|-----------------|---|---|--------------------|--------------------|
| 3-State XNOR | L | H | L | Input 1 | Input 2 |
| 3-State XNOR | L | H | L | Input 1 Input 2 | Input 2 Input 1 |

NLX1G99

MAXIMUM RATINGS

| Symbol | Parameter | Value | Unit |
|---------------|---|--|-------------|
| V_{CC} | DC Supply Voltage | -0.5 to +7.0 | V |
| V_{IN} | DC Input Voltage | -0.5 to +7.0 | V |
| V_{OUT} | DC Output Voltage Active Mode (High or Low State) Tristate Mode (Output at Hi-Z) Power Down Mode ($V_{CC} = 0$ V) | -0.5 to $V_{CC} + 0.5$ -0.5 to +7.0 -0.5 to +7.0 | V |
| I_{IK} | DC Input Diode Current $V_{IN} < GND$ | -50 | mA |
| I_{OK} | DC Output Diode Current $V_{OUT} < GND$ | -50 | mA |
| I_O | DC Output Source/Sink Current | ± 50 | mA |
| I_{CC} | DC Supply Current Per Supply Pin | ± 100 | mA |
| I_{GND} | DC Ground Current per Ground Pin | ± 100 | mA |
| T_{STG} | Storage Temperature Range | -65 to +150 | $^{\circ}C$ |
| T_L | Lead Temperature, 1 mm from Case for 10 Seconds | 260 | $^{\circ}C$ |
| T_J | Junction Temperature Under Bias | 150 | $^{\circ}C$ |
| MSL | Moisture Sensitivity | Level 1 | |
| F_R | Flammability Rating Oxygen Index: 28 to 34 | UL 94 V-0 @ 0.125 in | |
| V_{ESD} | ESD Withstand Voltage Human Body Model (Note 2) Machine Model (Note 3) Charged Device Model (Note 4) | > 2000 > 200 N/A | V |
| $I_{LATCHUP}$ | Latchup Performance Above V_{CC} and Below GND at 125 $^{\circ}C$ (Note 5) | ± 500 | mA |

Stresses exceeding those listed in the Maximum Ratings table may damage the device. If any of these limits are exceeded, device functionality should not be assumed, damage may occur and reliability may be affected.

1. Measured with minimum pad spacing on an FR4 board, using 10 mm-by-1 inch, 2 ounce copper trace no air flow.
2. Tested to EIA / JESD22-A114-A.
3. Tested to EIA / JESD22-A115-A.
4. Tested to JESD22-C101-A.
5. Tested to EIA / JESD78.

RECOMMENDED OPERATING CONDITIONS

| Symbol | Parameter | Min | Max | Unit |
|-----------------------|--|-------------|----------------------------------|-------------|
| V_{CC} | Positive DC Supply Voltage | 1.65 | 5.5 | V |
| V_{IN} | Digital Input Voltage | 0 | 5.5 | V |
| V_{OUT} | Output Voltage Active Mode (High or Low State) Tristate Mode (Output at Hi-Z) Power Down Mode ($V_{CC} = 0$ V) | 0 0 0 | V_{CC} 5.5 5.5 | V |
| T_A | Operating Free-Air Temperature | -55 | +125 | $^{\circ}C$ |
| $\Delta t / \Delta V$ | Input Transition Rise or Fall Rate $V_{CC} = 2.5$ V \pm 0.2 V $V_{CC} = 3.3$ V \pm 0.3 V $V_{CC} = 5.0$ V \pm 0.5 V | 0 0 0 | No Limit No Limit No Limit | nS/V |

Functional operation above the stresses listed in the Recommended Operating Ranges is not implied. Extended exposure to stresses beyond the Recommended Operating Ranges limits may affect device reliability.

NLX1G99

DC ELECTRICAL CHARACTERISTICS

| Symbol | Parameter | Conditions | V _{CC} (V) | T _A = 25°C | | T _A ≤ +85°C | | T _A = -55°C to +125°C | | Unit |
|------------------|---------------------------------------|--|---|--|---|--|---|--|---|------|
| | | | | Min | Max | Min | Max | Min | Max | |
| V _{T+} | Positive Threshold Voltage | | 1.65 | 0.79 | 1.16 | | 1.16 | | 1.16 | V |
| | | | 1.8 | 0.87 | 1.28 | | 1.28 | | 1.28 | |
| | | | 2.3 | 1.11 | 1.56 | | 1.56 | | 1.56 | |
| | | | 3.0 | 1.5 | 1.87 | | 1.87 | | 1.87 | |
| | | | 4.5 | 2.16 | 2.74 | | 2.74 | | 2.74 | |
| 5.5 | 2.61 | 3.33 | | 3.33 | | 3.33 | | | | |
| V _{T-} | Negative Threshold Voltage | | 1.65 | 0.35 | 0.62 | 0.35 | | 0.35 | | V |
| | | | 1.8 | 0.38 | 0.68 | 0.38 | | 0.38 | | |
| | | | 2.3 | 0.58 | 0.87 | 0.58 | | 0.58 | | |
| | | | 3.0 | 0.84 | 1.19 | 0.84 | | 0.84 | | |
| | | | 4.5 | 1.41 | 1.9 | 1.41 | | 1.41 | | |
| 5.5 | 1.78 | 2.29 | 1.78 | | 1.78 | | | | | |
| V _H | Hysteresis Voltage | | 1.65 | 0.30 | 0.62 | 0.30 | 0.62 | 0.30 | 0.62 | V |
| | | | 1.8 | 0.33 | 0.68 | 0.33 | 0.68 | 0.33 | 0.68 | |
| | | | 2.3 | 0.40 | 0.8 | 0.40 | 0.8 | 0.40 | 0.8 | |
| | | | 3.0 | 0.53 | 0.87 | 0.53 | 0.87 | 0.53 | 0.87 | |
| | | | 4.5 | 0.71 | 1.04 | 0.71 | 1.04 | 0.71 | 1.04 | |
| 5.5 | 0.8 | 1.2 | 0.8 | 1.2 | 0.8 | 1.2 | | | | |
| V _{OH} | Minimum High-Level Output Voltage | V _{IN} = V _{T-MIN} or V _{T+MAX} I _{OH} = -50 μA I _{OH} = -100 μA | 1.65-5.5 1.65-5.5 | V _{CC} -0.1 V _{CC} -0.1 | | V _{CC} -0.1 V _{CC} -0.1 | | V _{CC} -0.1 V _{CC} -0.1 | | V |
| | | V _{IN} = V _{T-MIN} or V _{T+MAX} I _{OH} = -4 mA I _{OH} = -8 mA I _{OH} = -12 mA I _{OH} = -16 mA I _{OH} = -24 mA I _{OH} = -32 mA | 1.65 2.3 2.7 3.0 3.0 4.5 | 1.2 1.9 2.2 2.4 2.3 3.8 | | 1.2 1.9 2.2 2.4 2.3 3.8 | | 1.2 1.9 2.2 2.4 2.3 3.8 | | V |
| V _{OL} | Maximum Low-Level Output Voltage | V _{IN} = V _{T-MIN} or V _{T+MAX} I _{OL} = 50 μA I _{OL} = 100 μA | 1.65-5.5 1.65-5.5 | | 0.1 0.1 | | 0.1 0.1 | | 0.1 0.1 | V |
| | | V _{IN} = V _{T-MIN} or V _{T+MAX} I _{OL} = 4 mA I _{OL} = 8 mA I _{OL} = 12 mA I _{OL} = 16 mA I _{OL} = 24 mA I _{OL} = 32 mA | 1.65 2.3 2.7 3.0 3.0 4.5 | | 0.45 0.3 0.4 0.4 0.55 0.55 | | 0.45 0.3 0.4 0.4 0.55 0.55 | | 0.45 0.3 0.4 0.4 0.55 0.55 | |
| I _{IN} | Input Leakage Current | 0 ≤ V _{IN} ≤ 5.5 V | 0 - 5.5 | | ±0.1 | | ±1.0 | | ±1.0 | μA |
| I _{off} | Power off Leakage Current | V _{IN} or V _O = 5.5 V | 0 | | ±1.0 | | ±10 | | ±10 | μA |
| I _{OZ} | Tri-state Output Leakage Current | V _O = V _{CC} or GND | 1.65-5.5 | | ±1.0 | | ±10 | | ±10 | μA |
| I _{CC} | Quiescent Supply Current | V _{IN} = V _{CC} or GND, I _O = 0 | 1.65-5.5 | | 1.0 | | 10 | | 10 | μA |
| ΔI _{CC} | Increase in I _{CC} Per Input | One input at (V _{CC} -0.6) V, other inputs at V _{CC} or GND | 2.3 - 5.5 | | 10 | | 100 | | 100 | μA |

Product parametric performance is indicated in the Electrical Characteristics for the listed test conditions, unless otherwise noted. Product performance may not be indicated by the Electrical Characteristics if operated under different conditions.

NLX1G99

AC ELECTRICAL CHARACTERISTICS (Input $t_r = t_f = 3.0$ ns)

| Symbol | Parameter | V_{CC} (V) | Test Condition | $T_A = 25^\circ\text{C}$ | | | $T_A \leq +85^\circ\text{C}$ | | $T_A = -55^\circ\text{C}$ to $+125^\circ\text{C}$ | | Unit |
|--------------------------|---|--|--|--------------------------|---------------------------|----------------------------|------------------------------|----------------------------|--|----------------------------|------|
| | | | | Min | Typ | Max | Min | Max | Min | Max | |
| t_{PLH} , t_{PHL} | Propagation Delay, Any Input to Output Y (See Test Circuit) | 1.65–1.95 2.3 – 2.7 3.0 – 3.6 4.5 – 5.5 | Refer to switch positions and loading conditions in Figure 17 to 21. | 4.3 2.4 1.7 1.3 | 12.8 7.1 5.2 4.0 | 25.1 10.2 6.7 4.5 | 4.3 2.4 1.7 1.3 | 25.1 10.2 6.9 4.9 | 4.3 2.4 1.7 1.3 | 25.1 10.2 7.0 5.0 | ns |
| t_{EN} | Output Enable Time, \overline{OE} to Y | 1.65–1.95 2.3 – 2.7 3.0 – 3.6 4.5 – 5.5 | Refer to switch positions and loading conditions in Figure 17 to 21. | 3.4 2.1 1.3 1.0 | | 24.7 11 7.5 5.7 | 3.4 2.1 1.3 1.0 | 24.7 12 8.0 6.2 | 3.4 2.1 1.3 1.0 | 24.7 12.2 8.3 6.5 | ns |
| t_{DIS} | Output Disable Time, \overline{OE} to Y | 1.65–1.95 2.3 – 2.7 3.0 – 3.6 4.5 – 5.5 | Refer to switch positions and loading conditions in Figure 17 to 21. | 4.0 2.7 3.5 2.0 | | 15.5 7.5 7.0 5.5 | 4.0 2.7 3.5 2.0 | 15.5 7.5 7.0 5.5 | 4.0 2.7 3.5 2.0 | 15.5 7.5 7.0 5.5 | ns |
| t_{PLH} , t_{PHL} | Propagation Delay, Any Input to Output Y (See Test Circuit) | 1.65–1.95 2.3 – 2.7 3.0 – 3.6 4.5 – 5.5 | Refer to switch Positions and loading conditions in Figure 22 to 26. | 4.3 2.5 2.3 1.6 | 13.6 7.8 5.6 4.4 | 25.7 10.7 7.6 5.2 | 4.3 2.5 2.3 1.6 | 25.7 10.7 7.6 5.2 | 4.3 2.5 2.3 1.6 | 25.7 10.7 7.6 5.2 | ns |
| t_{EN} | Output Enable Time, \overline{OE} to Y | 1.65–1.95 2.3 – 2.7 3.0 – 3.6 4.5 – 5.5 | Refer to switch Positions and loading conditions in Figure 22 to 26. | 4.2 2.4 2.0 1.7 | | 25.2 11.3 8.0 6.0 | 4.2 2.4 2.0 1.7 | 25.2 12.2 8.5 6.5 | 4.2 2.4 2.0 1.7 | 25.2 13 8.7 6.7 | ns |
| t_{DIS} | Output Disable Time, \overline{OE} to Y | 1.65–1.95 2.3 – 2.7 3.0 – 3.6 4.5 – 5.5 | Refer to switch Positions and loading conditions in Figure 22 to 26. | 3.7 2.0 2.1 1.0 | | 15 6.5 5.6 4.5 | 3.7 2.0 2.1 1.0 | 15 6.7 5.8 4.7 | 3.7 2.0 2.1 1.0 | 15 6.9 5.9 4.9 | ns |
| C_{IN} | Input Capacitance | 3.3 | | | 3.5 | | | | | | pF |
| C_O | Output Capacitance | 3.3 | | | 6.0 | | | | | | pF |
| C_{PD} | Power Dissipation Capacitance (Note 6) | 3.3 | $f = 10$ MHz | | 22 | | | | | | pF |

6. C_{PD} is defined as the value of the internal equivalent capacitance which is calculated from the dynamic operating current consumption without load. Average operating current can be obtained by the equation $I_{CC(OPR)} = C_{PD} \cdot V_{CC} \cdot f_{in} + I_{CC}$. C_{PD} is used to determine the no-load dynamic power consumption: $P_D = C_{PD} \cdot V_{CC}^2 \cdot f_{in} + I_{CC} \cdot V_{CC}$.

TEST CIRCUIT AND VOLTAGE WAVEFORMS

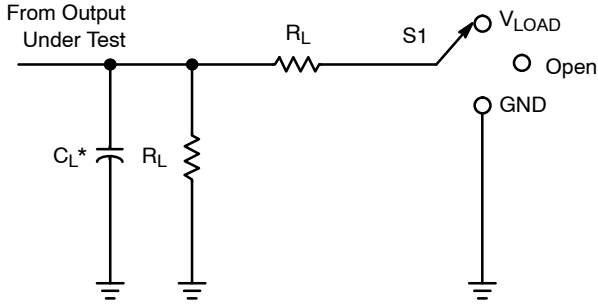

*CL includes probes and jig capacitance.

Figure 17. Load Circuit

| Test | S1 |
|-------------------|------------|
| t_{PLH}/t_{PHL} | Open |
| t_{PLZ}/t_{PZL} | V_{LOAD} |
| t_{PHZ}/t_{PZH} | GND |

| V_{CC} | Inputs | | V_M | V_{LOAD} | C_L | R_L | V_{Δ} |
|----------------------------------|----------|----------------------|------------|-------------------|-------|--------------|--------------|
| | V_I | t_r/t_f | | | | | |
| $1.8\text{ V} \pm 0.15\text{ V}$ | V_{CC} | $\leq 2\text{ ns}$ | $V_{CC}/2$ | $2 \times V_{CC}$ | 15 pF | 1 M Ω | 0.15 V |
| $2.5\text{ V} \pm 0.2\text{ V}$ | V_{CC} | $\leq 2\text{ ns}$ | $V_{CC}/2$ | $2 \times V_{CC}$ | 15 pF | 1 M Ω | 0.15 V |
| $3.3\text{ V} \pm 0.3\text{ V}$ | 3 V | $\leq 2.5\text{ ns}$ | 1.5 V | 6 V | 15 pF | 1 M Ω | 0.3 V |
| $5.5\text{ V} \pm 0.5\text{ V}$ | V_{CC} | $\leq 2.5\text{ ns}$ | $V_{CC}/2$ | $2 \times V_{CC}$ | 15 pF | 1 M Ω | 0.3 V |

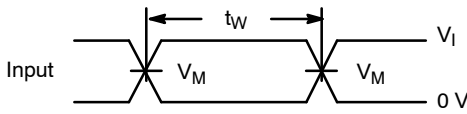

Figure 18. Voltage Waveforms Pulse Duration

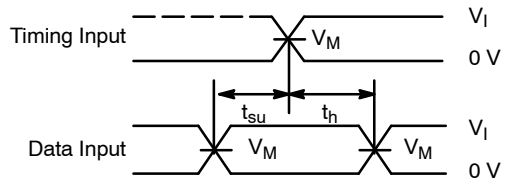

Figure 19. Voltage Waveforms Setup and Hold Times

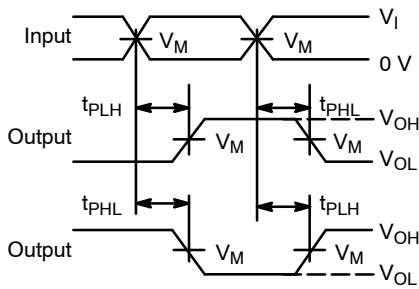

Figure 20. Voltage Waveforms Propagation Delay Times Inverting and Noninverting Outputs

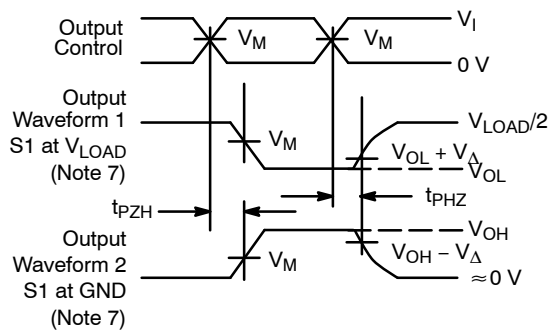
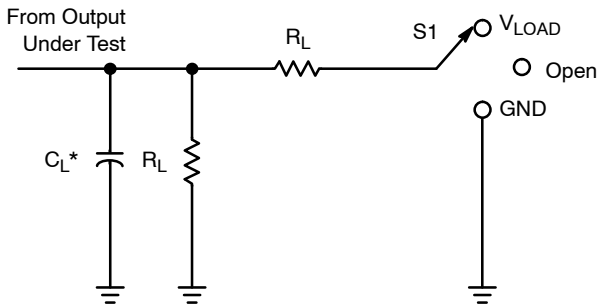

Figure 21. Voltage Waveforms Enable and Disable Times Low- and High-Level Enabling

7. Waveform 1 is for an output with internal conditions such that the output is low, except when disabled by the output control. Waveform 2 is for an output with internal conditions such that the output is high, except when disabled by the output control
8. All input pulses are supplied by generators having the following characteristics: PRR \leq 10 MHz, $Z_0 = 50 \Omega$.
9. The outputs are measured one at a time, with one transition per measurement.
10. All parameters are waveforms are not applicable to all devices.

NLX1G99



* C_L includes probes and jig capacitance.

Figure 22. Load Circuit

| Test | S1 |
|-------------------|------------|
| t_{PLH}/t_{PHL} | Open |
| t_{PLZ}/t_{PZL} | V_{LOAD} |
| t_{PHZ}/t_{PZH} | GND |

| V_{CC} | Inputs | | V_M | V_{LOAD} | C_L | R_L | V_{Δ} |
|----------------------------------|----------|----------------------|------------|-------------------|-------|--------------|--------------|
| | V_I | t_r/t_f | | | | | |
| $1.8\text{ V} \pm 0.15\text{ V}$ | V_{CC} | $\leq 2\text{ ns}$ | $V_{CC}/2$ | $2 \times V_{CC}$ | 30 pF | 1 k Ω | 0.15 V |
| $2.5\text{ V} \pm 0.2\text{ V}$ | V_{CC} | $\leq 2\text{ ns}$ | $V_{CC}/2$ | $2 \times V_{CC}$ | 30 pF | 500 Ω | 0.15 V |
| $3.3\text{ V} \pm 0.3\text{ V}$ | 3 V | $\leq 2.5\text{ ns}$ | 1.5 V | 6 V | 50 pF | 500 Ω | 0.3 V |
| $5.5\text{ V} \pm 0.5\text{ V}$ | V_{CC} | $\leq 2.5\text{ ns}$ | $V_{CC}/2$ | $2 \times V_{CC}$ | 50 pF | 500 Ω | 0.3 V |

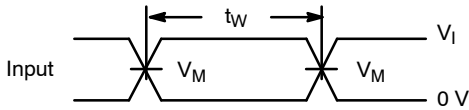

Figure 23. Voltage Waveforms Pulse Duration

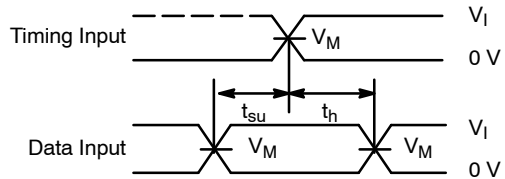

Figure 24. Voltage Waveforms Setup and Hold Times

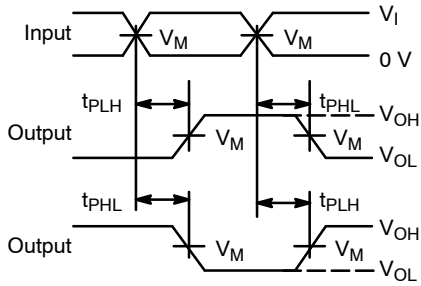

Figure 25. Voltage Waveforms Propagation Delay Times Inverting and Noninverting Outputs

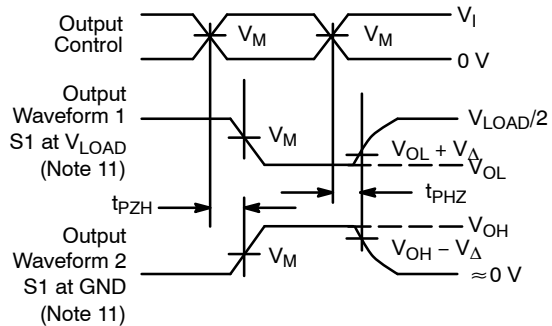

Figure 26. Voltage Waveforms Enable and Disable Times Low- and High-Level Enabling

11. Waveform 1 is for an output with internal conditions such that the output is low, except when disabled by the output control. Waveform 2 is for an output with internal conditions such that the output is high, except when disabled by the output control
12. All input pulses are supplied by generators having the following characteristics: $PRR \leq 10\text{ MHz}$, $Z_O = 50\ \Omega$.
13. The outputs are measured one at a time, with one transition per measurement.
14. All parameters are waveforms are not applicable to all devices.

NLX1G99

ORDERING INFORMATION

| Device | Package | Shipping [†] |
|-----------------------------------|---------------------------------------|-----------------------|
| NLX1G99DMUTCG | UDFN8, 1.95 x 1.0, 0.5P (Pb-Free) | 3000 / Tape & Reel |
| NLX1G99DMUTWG | UDFN8, 1.95 x 1.0, 0.5P (Pb-Free) | 3000 / Tape & Reel |
| NLX1G99EMUTCG (In Development) | UDFN8, 1.6 x 1.0, 0.4P (Pb-Free) | 3000 / Tape & Reel |
| NLX1G99FMUTCG (In Development) | UDFN8, 1.45 x 1.0, 0.35P (Pb-Free) | 3000 / Tape & Reel |

[†]For information on tape and reel specifications, including part orientation and tape sizes, please refer to our Tape and Reel Packaging Specifications Brochure, BRD8011/D.

NLX1G99

PACKAGE DIMENSIONS

UDFN8 1.6x1.0, 0.4P
CASE 517BY
ISSUE O

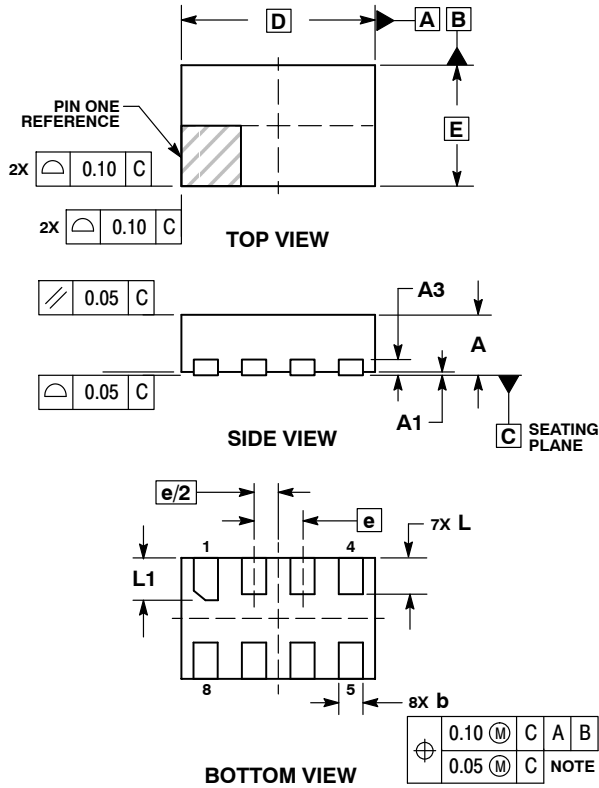

NOTES:

1. DIMENSIONING AND TOLERANCING PER ASME Y14.5M, 1994.
2. CONTROLLING DIMENSION: MILLIMETERS.
3. DIMENSION b APPLIES TO PLATED TERMINAL AND IS MEASURED BETWEEN 0.15 AND 0.20 MM FROM TERMINAL TIP.
4. PACKAGE DIMENSIONS EXCLUSIVE OF BURRS AND MOLD FLASH.

| MILLIMETERS | | |
|-------------|----------|------|
| DIM | MIN | MAX |
| A | 0.45 | 0.55 |
| A1 | 0.00 | 0.05 |
| A3 | 0.13 REF | |
| b | 0.15 | 0.25 |
| D | 1.60 BSC | |
| E | 1.00 BSC | |
| e | 0.40 BSC | |
| L | 0.25 | 0.35 |
| L1 | 0.30 | 0.40 |

RECOMMENDED SOLDERING FOOTPRINT*

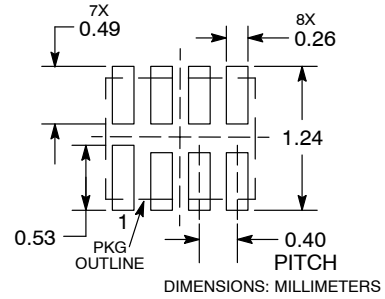

*For additional information on our Pb-Free strategy and soldering details, please download the ON Semiconductor Soldering and Mounting Techniques Reference Manual, SOLDERRM/D.

NLX1G99

PACKAGE DIMENSIONS

UDFN8 1.45x1.0, 0.35P
CASE 517BZ
ISSUE O

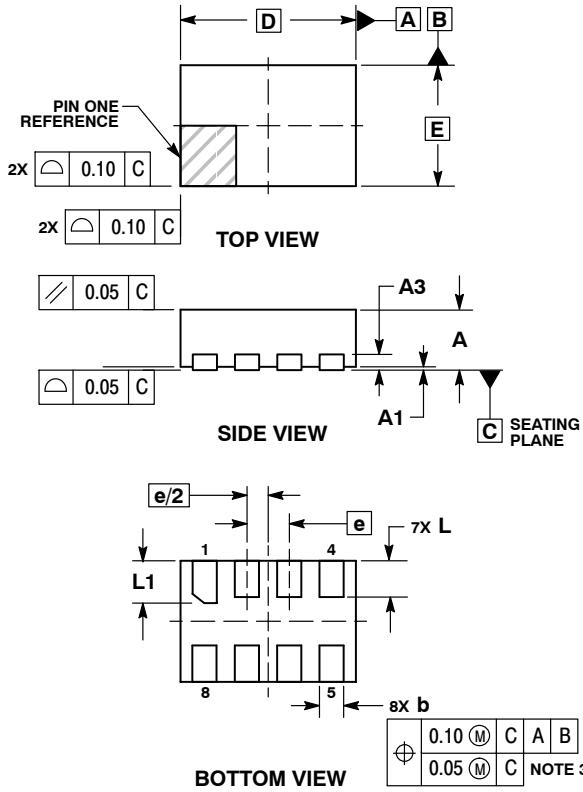

NOTES:

1. DIMENSIONING AND TOLERANCING PER ASME Y14.5M, 1994.
2. CONTROLLING DIMENSION: MILLIMETERS.
3. DIMENSION b APPLIES TO PLATED TERMINAL AND IS MEASURED BETWEEN 0.15 AND 0.20 MM FROM TERMINAL TIP.
4. PACKAGE DIMENSIONS EXCLUSIVE OF BURRS AND MOLD FLASH.

| DIM | MILLIMETERS | |
|-----|-------------|------|
| | MIN | MAX |
| A | 0.45 | 0.55 |
| A1 | 0.00 | 0.05 |
| A3 | 0.13 REF | |
| b | 0.15 | 0.25 |
| D | 1.45 BSC | |
| E | 1.00 BSC | |
| e | 0.35 BSC | |
| L | 0.25 | 0.35 |
| L1 | 0.30 | 0.40 |

RECOMMENDED SOLDERING FOOTPRINT*

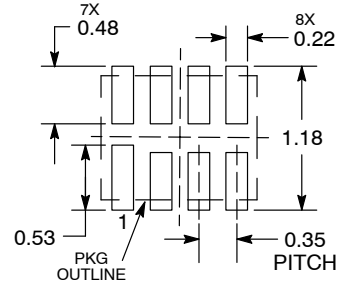

DIMENSIONS: MILLIMETERS

*For additional information on our Pb-Free strategy and soldering details, please download the ON Semiconductor Soldering and Mounting Techniques Reference Manual, SOLDERRM/D.

NLX1G99

PACKAGE DIMENSIONS

UDFN8 1.95x1.0, 0.5P
CASE 517CA
ISSUE O

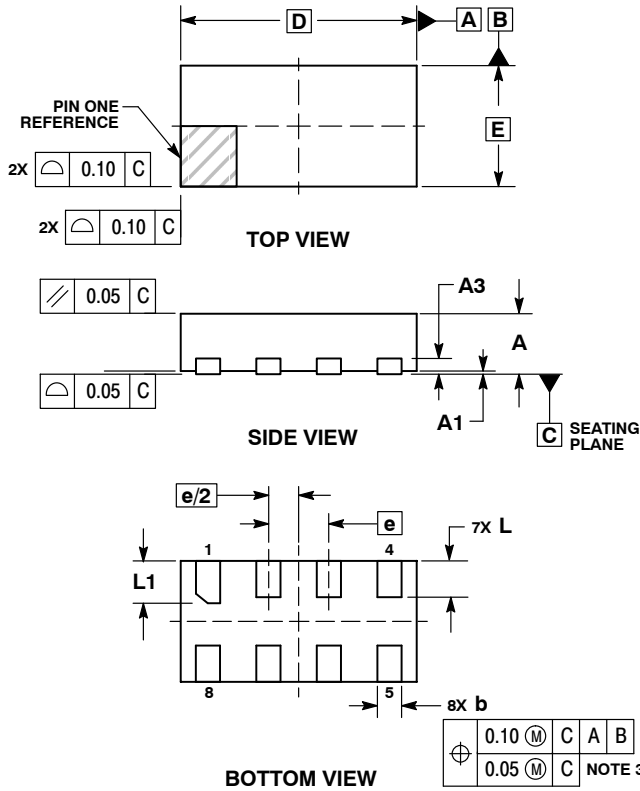

NOTES:

1. DIMENSIONING AND TOLERANCING PER ASME Y14.5M, 1994.
2. CONTROLLING DIMENSION: MILLIMETERS.
3. DIMENSION b APPLIES TO PLATED TERMINAL AND IS MEASURED BETWEEN 0.15 AND 0.20 MM FROM TERMINAL TIP.
4. PACKAGE DIMENSIONS EXCLUSIVE OF BURRS AND MOLD FLASH.

| DIM | MILLIMETERS | |
|-----|-------------|------|
| | MIN | MAX |
| A | 0.45 | 0.55 |
| A1 | 0.00 | 0.05 |
| A3 | 0.13 REF | |
| b | 0.15 | 0.25 |
| D | 1.95 BSC | |
| E | 1.00 BSC | |
| e | 0.50 BSC | |
| L | 0.25 | 0.35 |
| L1 | 0.30 | 0.40 |

RECOMMENDED SOLDERING FOOTPRINT*

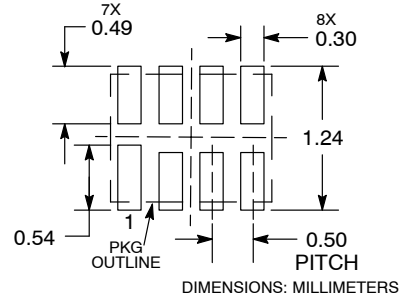

*For additional information on our Pb-Free strategy and soldering details, please download the ON Semiconductor Soldering and Mounting Techniques Reference Manual, SOLDERRM/D.

MiniGate is a trademark of Semiconductor Components Industries, LLC (SCILLC).

ON Semiconductor and are trademarks of Semiconductor Components Industries, LLC dba ON Semiconductor or its subsidiaries in the United States and/or other countries. ON Semiconductor owns the rights to a number of patents, trademarks, copyrights, trade secrets, and other intellectual property. A listing of ON Semiconductor's product/patent coverage may be accessed at www.onsemi.com/site/pdf/Patent-Marking.pdf. ON Semiconductor reserves the right to make changes without further notice to any products herein. ON Semiconductor makes no warranty, representation or guarantee regarding the suitability of its products for any particular purpose, nor does ON Semiconductor assume any liability arising out of the application or use of any product or circuit, and specifically disclaims any and all liability, including without limitation special, consequential or incidental damages. Buyer is responsible for its products and applications using ON Semiconductor products, including compliance with all laws, regulations and safety requirements or standards, regardless of any support or applications information provided by ON Semiconductor. "Typical" parameters which may be provided in ON Semiconductor data sheets and/or specifications can and do vary in different applications and actual performance may vary over time. All operating parameters, including "Typicals" must be validated for each customer application by customer's technical experts. ON Semiconductor does not convey any license under its patent rights nor the rights of others. ON Semiconductor products are not designed, intended, or authorized for use as a critical component in life support systems or any FDA Class 3 medical devices or medical devices with a same or similar classification in a foreign jurisdiction or any devices intended for implantation in the human body. Should Buyer purchase or use ON Semiconductor products for any such unintended or unauthorized application, Buyer shall indemnify and hold ON Semiconductor and its officers, employees, subsidiaries, affiliates, and distributors harmless against all claims, costs, damages, and expenses, and reasonable attorney fees arising out of, directly or indirectly, any claim of personal injury or death associated with such unintended or unauthorized use, even if such claim alleges that ON Semiconductor was negligent regarding the design or manufacture of the part. ON Semiconductor is an Equal Opportunity/Affirmative Action Employer. This literature is subject to all applicable copyright laws and is not for resale in any manner.

PUBLICATION ORDERING INFORMATION

LITERATURE FULFILLMENT:
Literature Distribution Center for ON Semiconductor
19521 E. 32nd Pkwy, Aurora, Colorado 80011 USA
Phone: 303-675-2175 or 800-344-3860 Toll Free USA/Canada
Fax: 303-675-2176 or 800-344-3867 Toll Free USA/Canada
Email: orderlit@onsemi.com

N. American Technical Support: 800-282-9855 Toll Free
USA/Canada
Europe, Middle East and Africa Technical Support:
Phone: 421 33 790 2910

ON Semiconductor Website: www.onsemi.com
Order Literature: <http://www.onsemi.com/orderlit>

For additional information, please contact your local Sales Representative