



**SPECIFICATION SHEET**

<b>SPECIFICATION SHEET NO.</b>	N1115 - DO218ABSM8S14A
<b>DATE</b>	Nov. 15, 2021
<b>REVISION</b>	A0
<b>DESCRIPTION</b>	<p>SMD Transient Voltage Suppressor (TVs) Diodes, DO-218AB series,  <b>SM8S14A</b> Type, 2 Pads, Uni-directional            Stand-off Voltage <b>14V</b>. Reverse Surge Current. <b>284A Max</b>.            Operating Temp. Range -55°C ~+175°C            Package in Tape/Reel, 750pcs/13" Reel            RoHS/RoHS III compliant</p>
<b>CUSTOMER</b>	
<b>CUSTOMER PART NUMBER</b>	
<b>CROSS REF. PART NUMBER</b>	
<b>ORIGINAL PART NUMBER</b>	MDD SM8S14A
<b>PART CODE</b>	DO218ABSM8S14A

<b>VENDOR APPROVE</b>		
Issued/Checked/Approved		
		
DATE: Nov. 15, 2021		

<b>CUSTOMER APPROVE</b>
DATE:

**SMD TRANSIENT VOLTAGE SUPPRESSORS DO-218AB SERIES**



**MAIN FEATURE**

- Round Chip Produced By Chemical Method
- Junction Passivated By Polyimide
- T J – 175 °C Capability Suitable For High Reliability And Automotive Requirement
- Available In both Uni-directional and Bi-directional Polarity
- Low Leakage Current
- Low Forward Voltage Drop
- High Surge Capability
- Meet ISO7637-2 Surge Specification (Varied By Test Condition)
- Meet MSL Level 1, Per J-STD\_020, LF Max. Peak Of 245 °C
- AEC – Q101 Quality

**APPLICATION**

- Use In Sensitive Electronics Protection Against Voltage Transients Included By Inductive Load Switching And Lighting, Especially For Automotive Load Dump Protection Application

**RFQ**  
[Request For Quotation](#)

**PART CODE GUIDE**

DO218AB	SM8S14A
1	2

1) **DO218AB**: SMD Transient Voltage Suppressor (TVs) Diodes, DO218AB series

2) **SM8S14A**: Type code for original part number SM8S14A

**SMD TRANSIENT VOLTAGE SUPPRESSORS DO-218AB SERIES**

**DIMENSION (Unit: mm)**

Image for reference

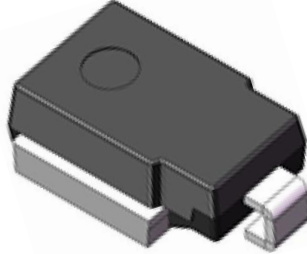

Marking: SM8S14A

DO-218AB

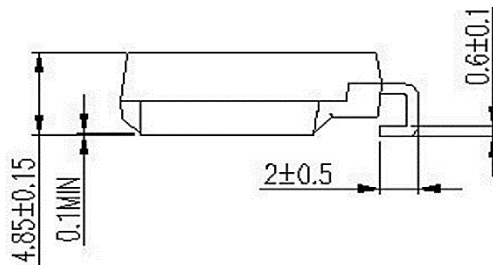
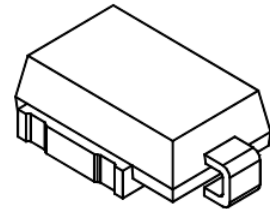
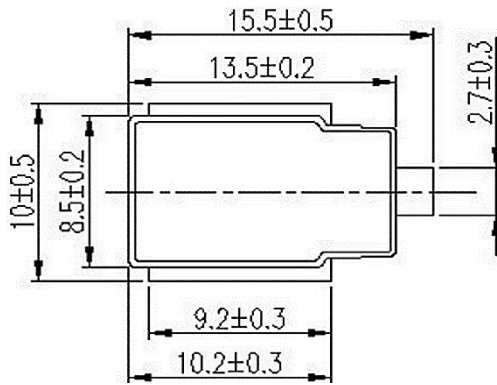

Recommend Pad Layout

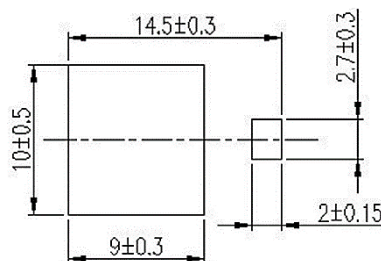

**SMD TRANSIENT VOLTAGE SUPPRESSORS DO-218AB SERIES**
**MECHANICAL DATA**

Case	Terminals	Polarity	Mounting Position	Unit Weight
JEDEC DO-218AB molded plastic	Matte tin plated leads, solderable per J-STD-002 & JESD22-B102	Heatsink is Anode	Meets UL 94 V-0 flammability rating base P/NHE3_X – RoHS Compliant & AEC – Q101 qualified (X: denotes revision code e. g A, B...)	2.60 g/pc

**MAX. RATING & CHARACTERISTICS - Ratings at 25°C ambient temperature unless otherwise specified.**

Parameter	SYMBOLS	VALUE			UNITS
		Min.	Typical	Max.	
Peak Pulse Power Dissipation @10/1000µs Waveform	P <sub>ppm</sub>		6600		W
Peak Pulse Power Dissipation @10/1000µs Waveform	P <sub>ppm</sub>		5200		W
Power Dissipation On Infinite Heatsink @ T <sub>c</sub> = 25 °C ( Fig. 1)	P <sub>D</sub>		8.0		W
Peak Pulse Current On 10/1000µs Waveform (Note 1)	I <sub>ppm</sub>			284	A
Peak Forward Surge Current 8.3 Ms Single Half Sine- Wave	I <sub>FSM</sub>		700		A
Thermal Resistance Junction To Case	R <sub>θJA</sub>		0.90		°C/W
Operating Junction Temperature Range	T <sub>J</sub>	-55		+175	°C
Storage Temperature Range	T <sub>STG</sub>	-55		+175	°C

Note

1. Non-repetitive current pulse derated above TA=25 °C

## SMD TRANSIENT VOLTAGE SUPPRESSORS DO-218AB SERIES

**ELECTRICAL CHARACTERISTICS - Ratings at 25°C**

Parameter	SYMBOLS	VALUE			UNITS
		Min.	Typical	Max.	
Breakdown Voltage	V <sub>BR</sub>	15.6	16.4	17.2	V
Test Current	I <sub>T</sub>		5.0		mA
Reverse Stand-Off	V <sub>WM</sub>		14.0		V
Reverse Leakage @ V <sub>WM</sub>	I <sub>D</sub>			10.0	μA
Reverse Leakage @ V <sub>WM</sub> , T <sub>J</sub> = 175 °C	I <sub>D</sub>			150	μA
Peak Pulse Current @ 10/1000 μs Wave-form	I <sub>PPM</sub>			284	A
Clamping Voltage @ I <sub>PPM</sub>	V <sub>C</sub>			23.2	V
Temp. Coefficient of V <sub>BR</sub> (Note 1)	α <sub>T</sub>		0.078		%/ °C

**Note**

1. To calculate V<sub>BR</sub> vs Junction temperature, use the following formula: V<sub>BR</sub> at T<sub>J</sub> = V<sub>BR</sub> at 25 °C x 1+ α<sub>T</sub> x (T<sub>J</sub> -25)
2. For all type Max. V<sub>F</sub> = 1.8V at I<sub>F</sub> = 100 A measured on 8.3ms single half Sine-wave or equivalent square wave, duty cycle = 4 pulses per minute Max.

**SMD TRANSIENT VOLTAGE SUPPRESSORS DO-218AB SERIES**
**RELIABILITY**

Number	Experiment Items	Experiment Method And Conditions	Reference Documents
1	Solder Resistance Test	Test 260°C± 5°C for 10 ± 2 sec. Immerse body into solder 1/16" ± 1/32"	MIL-STD-750D METHOD-2031.2
2	Solderability Test	230°C ±5°C for 5 sec.	MIL-STD-750D METHOD-2026.1 0
3	Pull Test	1 kg in axial lead direction for 10 sec.	MIL-STD-750D METHOD-2036.4
4	Bend Test	0.5Kg Weight Applied To Each Lead, Bending Arcs 90 °C ± 5 °C For 3 Times	MIL-STD-750D METHOD-2036.4
5	High Temperature Reverse Bias Test	TA=100°C for 1000 Hours at VR=80% Rated VR	MIL-STD-750D METHOD-1038.4
6	Forward Operation Life Test	TA=25°C Rated Average Rectified Current	MIL-STD-750D METHOD-1027.3
7	Intermittent Operation Life Test	On state: 5 min with rated IRMS Power Off state: 5 min with Cool Forced Air. On and off for 1000 cycles.	MIL-STD-750D METHOD-1036.3
8	Pressure Cooker Test	15 PSIG, TA=121°C, 4 hours	MIL-S-19500 APPENOIXC
9	Temperature Cycling Test	-55°C~+125°C; 30 Minutes For Dwelled Time 5 minutes for transferred time. Total: 10 cycles.	MIL-STD-750D METHOD-1051.7
10	Thermal Shock Test	0°C for 5 minutes., 100°C for 5minutes, Total: 10 cycles	MIL-STD-750D METHOD-1056.7
11	Forward Surge Test	8.3ms Single Sale Sine-wave One Surge.	MIL-STD-750D METHOD-4066.4
12	Humidity Test	TA=65°C, RH=98% for 1000 hours.	MIL-STD-750D METHOD-1021.3
13	High Temperature Storage life Test	150°C for 1000 Hours	MIL-STD-750D METHOD-1031.5

**SMD TRANSIENT VOLTAGE SUPPRESSORS DO-218AB SERIES**

**SUGGESTED REFLOW PROFILE (For Reference Only)**

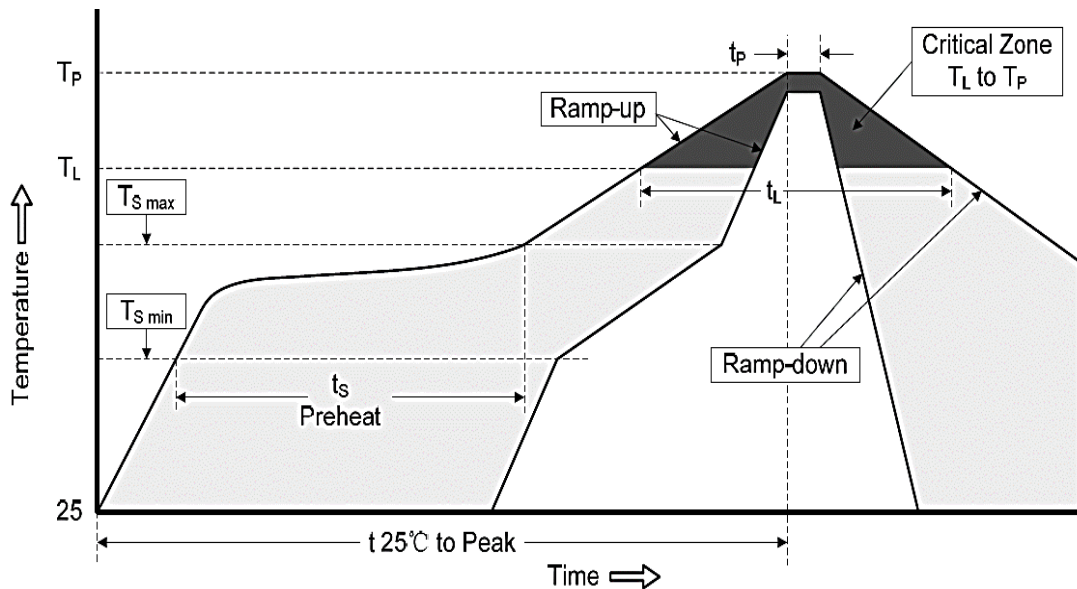

<b>Profile Feature</b>		Pb-Free Assembly
<b>Average Ramp-up Rate (Ts Max to Tp)</b>		3°C/second Max
<b>Preheat</b>	<b>Temperature Min (Ts Min.)</b>	150°C
	<b>Temperature Max (Ts Max.)</b>	200°C
	<b>Time (ts Min. to ts Max.)</b>	60 ~ 180 seconds
<b>Time maintained above</b>	<b>Temperature (Tl)</b>	217°C
	<b>Time (tl)</b>	60 ~ 150 seconds
<b>Peak/Classification Temperature (Tp)</b>		260 °C
<b>Time within 5°C of actual Peak Temperature (tp)</b>		20 ~ 40 seconds
<b>Ramp-down rate</b>		6 °C /Second Max.
<b>Time 25 °C to Peak Temperature</b>		6 minutes Max.
<b>Suggest reflow times</b>		3 Times Max.

**SMD TRANSIENT VOLTAGE SUPPRESSORS DO-218AB SERIES**

**RATINGS AND CHARACTERISTIC CURVES (For Reference Only)**

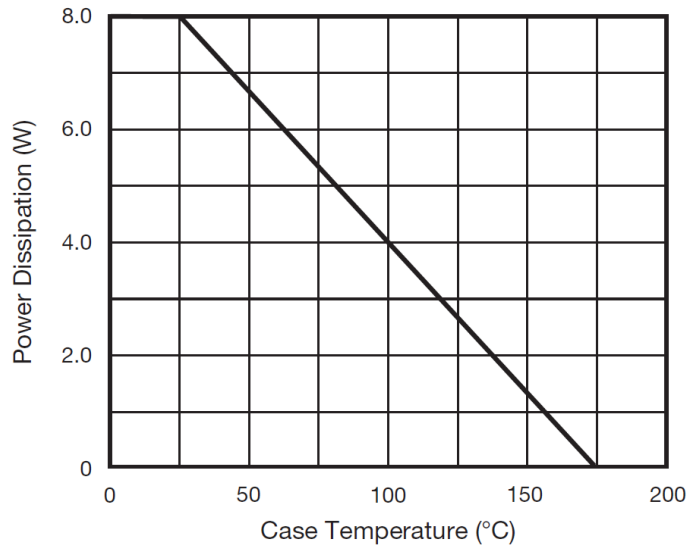

Fig. 1 - Power Derating Curve

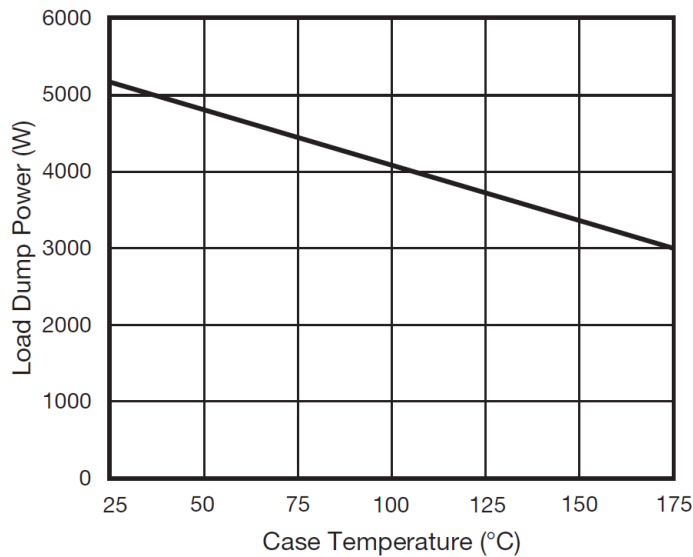

Fig. 2 - Load Dump Power Characteristics (10 ms Exponential Waveform)



**SMD TRANSIENT VOLTAGE SUPPRESSORS DO-218AB SERIES**

**RATINGS AND CHARACTERISTIC CURVES (For Reference Only)**

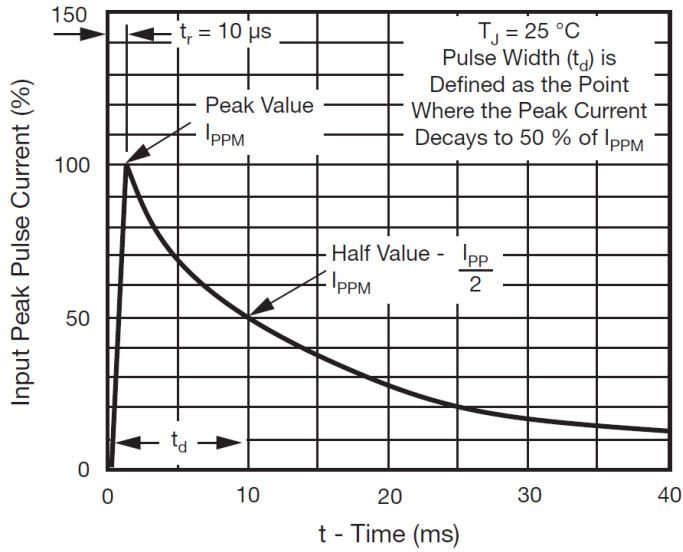

Fig. 3 - Pulse Waveform

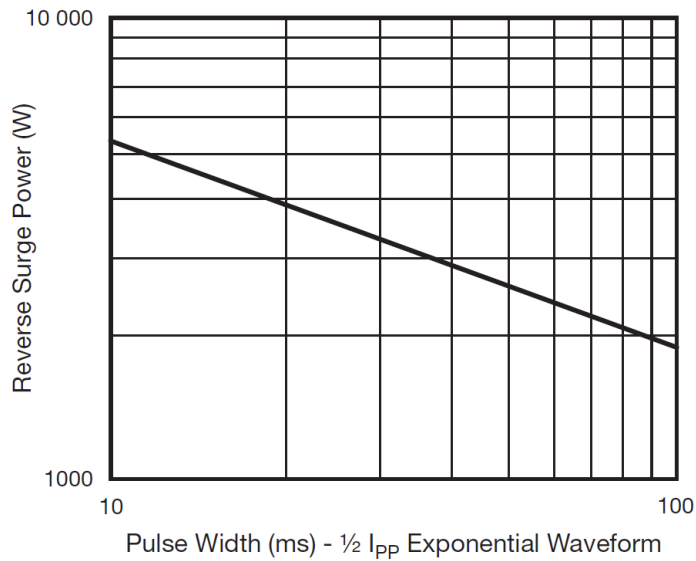

Fig. 4 - Reverse Power Capability

**SMD TRANSIENT VOLTAGE SUPPRESSORS DO-218AB SERIES**

**RATINGS AND CHARACTERISTIC CURVES (For Reference Only)**

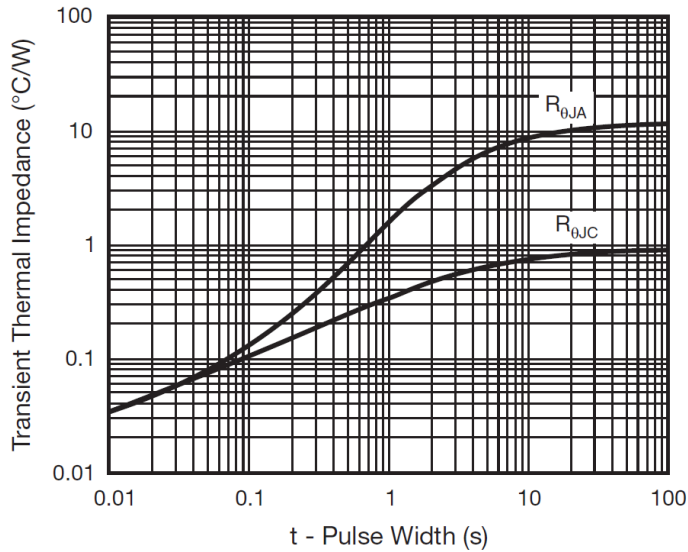

Fig. 5 - Typical Transient Thermal Impedance

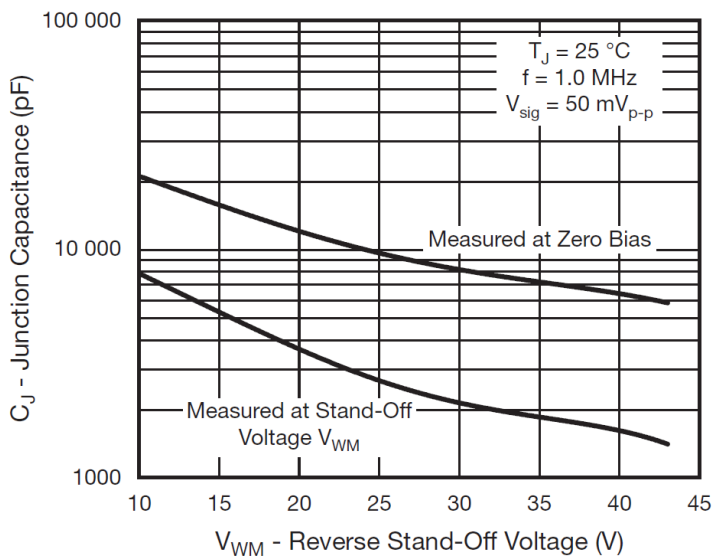
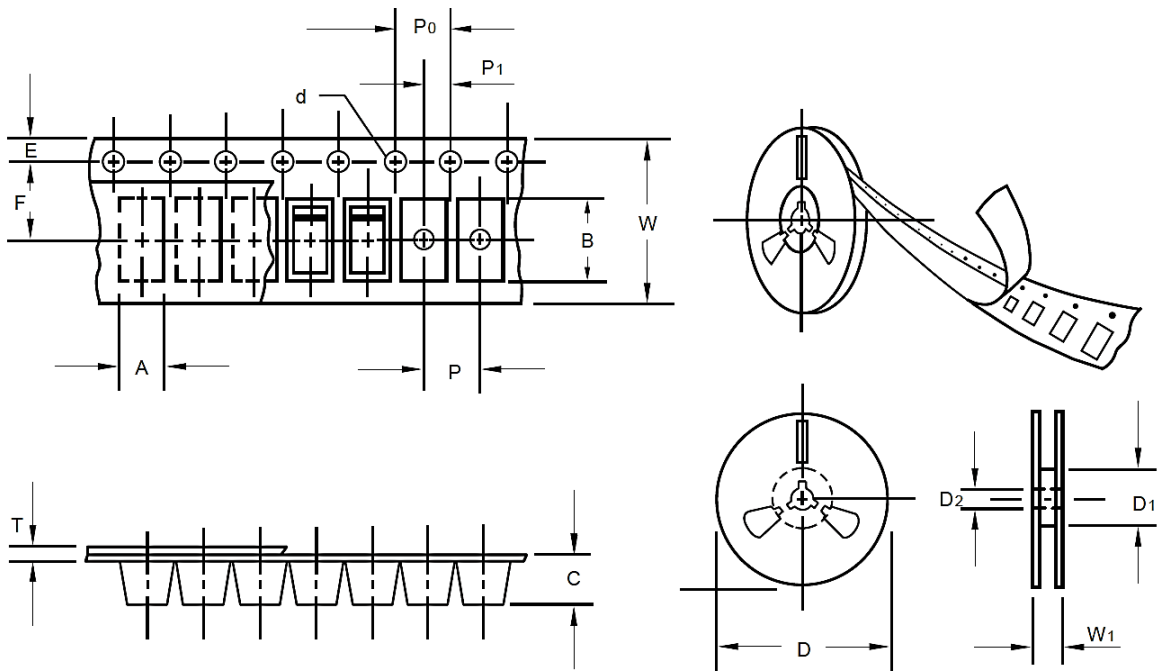

Fig. 6 - Typical Junction Capacitance

**SMD TRANSIENT VOLTAGE SUPPRESSORS DO-218AB SERIES**

**TAPE/REEL (Unit: mm)**

All Devices are packed in accordance with EIA standard RS-481-A and specifications. 750pcs/Reel



Item	Symbol	Tolerance	DO-218AB
Carrier width	A	+/-0.30	10.80
Carrier Length	B	+/-0.30	16.13
Carrier Depth	C	+/-0.20	6.00
Sprocket hole	d	+/-0.20	1.55
13"Reel outside diameter	D	+/-0.30	330.00
13"Reel inner diameter	D1	-	50.0 Min.
Feed hole diameter	D2	-	20.2 Min.
Sprocket hole position	E	+/-0.2	1.75
Punch hole position	F	+/-0.20	11.50
Punch hole pitch	P	+/-0.20	16.0
Sprocket hole pitch	P0	+/-0.20	4.00
Embossment center	P1	+/-0.20	2.00
Overall tape thickness	T	-	-
Tape width	W	+/-0.20	24.00
Reel width	W1	-	30.40 Max.

**SMD TRANSIENT VOLTAGE SUPPRESSORS DO-218AB SERIES**

**PACKAGE for reference**

Case Code	DO- 218AB
Reel Size	13"
Reel Size	330 mm
MPQ/Reel	750 pcs
Qty. /Box	1500 pcs
G.W/Box	5.5 kgs

**DISCLAIMER**

NextGen Component, Inc. reserves the right to make changes to the product(s) and or information contained herein without notice. No liability is assumed as a result of their use or application. No rights under any patent accompany the sale of any such product(s) or information