

Trench gate field-stop IGBT, H series 1200 V, 15 A high speed

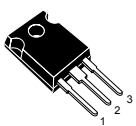

TO-247

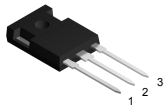

TO-247 long leads

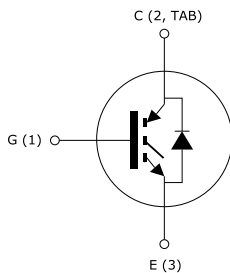

Features

- Maximum junction temperature: $T_J = 175\text{ °C}$
- High speed switching series
- Minimized tail current
- $V_{CE(sat)} = 2.1\text{ V @ } I_C = 15\text{ A}$
- 5 μs minimum short circuit withstand time at $T_J = 150\text{ °C}$
- Safe paralleling
- Low thermal resistance
- Very fast recovery antiparallel diode

Applications

- Photovoltaic inverters
- Uninterruptible power supply
- Welding
- Power factor correction
- High frequency converters

Description

This device is an IGBT developed using an advanced proprietary trench gate field-stop structure. The device is part of the H series of IGBTs, which represents an optimum compromise between conduction and switching losses to maximize the efficiency of high-switching frequency converters. Furthermore, a slightly positive $V_{CE(sat)}$ temperature coefficient and very tight parameter distribution result in safer paralleling operation.



Product status links

[STGW15H120DF2](#)
[STGWA15H120DF2](#)

Product summary

Order code	STGW15H120DF2
Marking	G15H120DF2
Package	TO-247
Packing	Tube
Order code	STGWA15H120DF2
Marking	G15H120DF2
Package	TO-247 long leads
Packing	Tube

1 Electrical ratings

Table 1. Absolute maximum ratings

Symbol	Parameter	Value	Unit
V_{CES}	Collector-emitter voltage ($V_{GE} = 0$ V)	1200	V
I_C	Continuous collector current at $T_C = 25$ °C	30	A
	Continuous collector current at $T_C = 100$ °C	15	
$I_{CP}^{(1)}$	Pulsed collector current	60	A
V_{GE}	Gate-emitter voltage	± 20	V
	Transient gate-emitter voltage ($t_p \leq 10$ μ s, $D \leq 0.01$)	± 30	
I_F	Continuous forward current at $T_C = 25$ °C	30	A
	Continuous forward current at $T_C = 100$ °C	15	
$I_{FP}^{(1)}$	Pulsed forward current	60	A
P_{TOT}	Total power dissipation at $T_C = 25$ °C	259	W
T_{STG}	Storage temperature range	- 55 to 150	°C
T_J	Operating junction temperature range	- 55 to 175	°C

1. Pulse width limited by maximum junction temperature.

Table 2. Thermal data

Symbol	Parameter	Value	Unit
R_{thJC}	Thermal resistance, junction-to-case IGBT	0.58	°C/W
	Thermal resistance, junction-to-case diode	1.47	
R_{thJA}	Thermal resistance, junction-to-ambient	50	°C/W

2 Electrical characteristics

$T_J = 25\text{ °C}$ unless otherwise specified.

Table 3. Static characteristics

Symbol	Parameter	Test conditions	Min.	Typ.	Max.	Unit
$V_{(BR)CES}$	Collector-emitter breakdown voltage	$V_{GE} = 0\text{ V}, I_C = 2\text{ mA}$	1200			V
$V_{CE(sat)}$	Collector-emitter saturation voltage	$V_{GE} = 15\text{ V}, I_C = 15\text{ A}$		2.1	2.6	V
		$V_{GE} = 15\text{ V}, I_C = 15\text{ A}, T_J = 125\text{ °C}$		2.4		
		$V_{GE} = 15\text{ V}, I_C = 15\text{ A}, T_J = 175\text{ °C}$		2.5		
V_F	Forward on-voltage	$I_F = 25\text{ A}$		3.5	4.4	V
		$I_F = 25\text{ A}, T_J = 125\text{ °C}$		2.6		
		$I_F = 25\text{ A}, T_J = 175\text{ °C}$		2.2		
$V_{GE(th)}$	Gate threshold voltage	$V_{CE} = V_{GE}, I_C = 500\text{ }\mu\text{A}$	5	6	7	V
I_{CES}	Collector cut-off current	$V_{GE} = 0\text{ V}, V_{CE} = 1200\text{ V}$			25	μA
I_{GES}	Gate-emitter leakage current	$V_{CE} = 0\text{ V}, V_{GE} = \pm 20\text{ V}$			250	nA

Table 4. Dynamic characteristics

Symbol	Parameter	Test conditions	Min.	Typ.	Max.	Unit
C_{ies}	Input capacitance	$V_{CE} = 25\text{ V}, f = 1\text{ MHz}, V_{GE} = 0\text{ V}$	-	1300	-	pF
C_{oes}	Output capacitance		-	105	-	pF
C_{res}	Reverse transfer capacitance		-	32	-	pF
Q_g	Total gate charge	$V_{CC} = 960\text{ V}, I_C = 15\text{ A}, V_{GE} = 15\text{ V}$ (see Figure 28. Gate charge test circuit)	-	67	-	nC
Q_{ge}	Gate-emitter charge		-	8	-	nC
Q_{gc}	Gate-collector charge		-	38	-	nC

Table 5. IGBT switching characteristics (inductive load)

Symbol	Parameter	Test conditions	Min.	Typ.	Max.	Unit
$t_{d(on)}$	Turn-on delay time	$V_{CE} = 600\text{ V}$, $I_C = 15\text{ A}$, $R_G = 10\ \Omega$, $V_{GE} = 15\text{ V}$ (see Figure 27. Test circuit for inductive load switching)		23	-	ns
t_r	Current rise time			7.4	-	ns
$(di/dt)_{on}$	Turn-on current slope			1621	-	A/ μ s
$t_{d(off)}$	Turn-off delay time			111	-	ns
t_f	Current fall time			111	-	ns
$E_{on}^{(1)}$	Turn-on switching energy			0.38	-	mJ
$E_{off}^{(2)}$	Turn-off switching energy			0.37	-	mJ
E_{ts}	Total switching energy			0.75	-	mJ
$t_{d(on)}$	Turn-on delay time		$V_{CE} = 600\text{ V}$, $I_C = 15\text{ A}$, $R_G = 10\ \Omega$, $V_{GE} = 15\text{ V}$, $T_J = 175\text{ }^\circ\text{C}$ (see Figure 27. Test circuit for inductive load switching)		23.5	-
t_r	Current rise time			8	-	ns
$(di/dt)_{on}$	Turn-on current slope			1525	-	A/ μ s
$t_{d(off)}$	Turn-off delay time			118	-	ns
t_f	Current fall time			253	-	ns
$E_{on}^{(1)}$	Turn-on switching energy			0.65	-	mJ
$E_{off}^{(2)}$	Turn-off switching energy			0.93	-	mJ
E_{ts}	Total switching energy			1.58	-	mJ
t_{sc}	Short-circuit withstand time	$V_{CE} = 600\text{ V}$, $V_{GE} = 15\text{ V}$, $T_J = 150\text{ }^\circ\text{C}$		5		-

1. Including the reverse recovery of the diode.

2. Including the tail of the collector current.

Table 6. Diode switching characteristics (inductive load)

Symbol	Parameter	Test conditions	Min.	Typ.	Max.	Unit	
t_{rr}	Reverse recovery time	$I_F = 15\text{ A}$, $V_R = 600\text{ V}$, $di/dt = 1000\text{ A}/\mu\text{s}$, $V_{GE} = 15\text{ V}$ (see Figure 27. Test circuit for inductive load switching)	-	231	-	ns	
Q_{rr}	Reverse recovery charge			-	0.72	-	μ C
I_{rrm}	Reverse recovery current			-	14.5	-	A
dI_{rr}/dt	Peak rate of fall of reverse recovery current during t_b			-	1200	-	A/ μ s
E_{rr}	Reverse recovery energy			-	0.4	-	mJ
t_{rr}	Reverse recovery time		$I_F = 15\text{ A}$, $V_R = 600\text{ V}$, $di/dt = 1000\text{ A}/\mu\text{s}$, $V_{GE} = 15\text{ V}$, $T_J = 175\text{ }^\circ\text{C}$ (see Figure 27. Test circuit for inductive load switching)	-	414	-	ns
Q_{rr}	Reverse recovery charge			-	2.2	-	μ C
I_{rrm}	Reverse recovery current			-	21.5	-	A
dI_{rr}/dt	Peak rate of fall of reverse recovery current during t_b			-	632	-	A/ μ s
E_{rr}	Reverse recovery energy			-	1.3	-	mJ

2.1 Electrical characteristics (curves)
Figure 1. Power dissipation vs case temperature

Figure 2. Collector current vs case temperature

Figure 3. Output characteristics ($T_J = 25^\circ C$)

Figure 4. Output characteristics ($T_J = 175^\circ C$)

Figure 5. $V_{CE(sat)}$ vs junction temperature

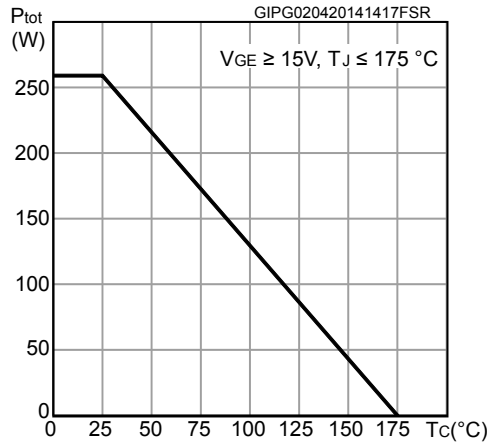
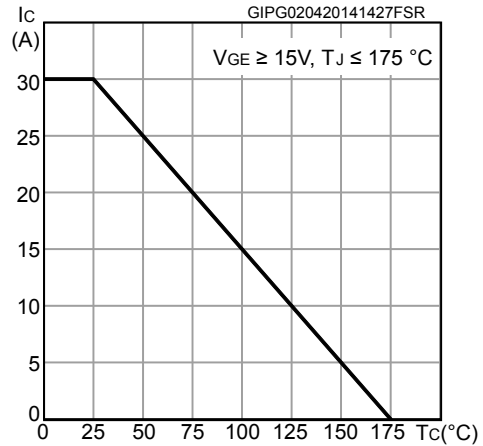
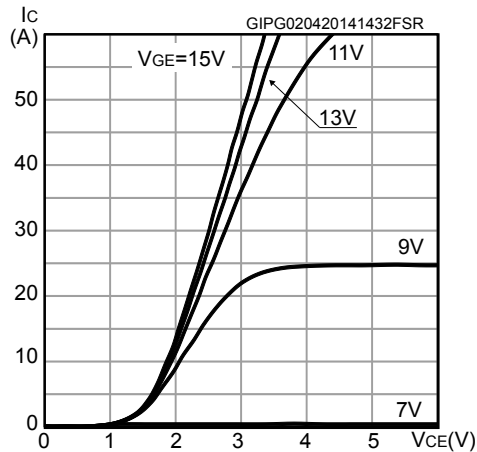
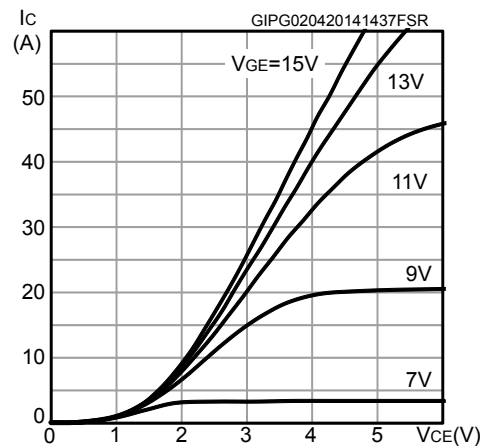
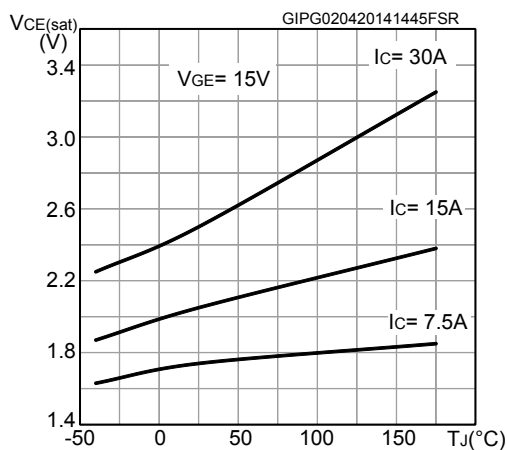
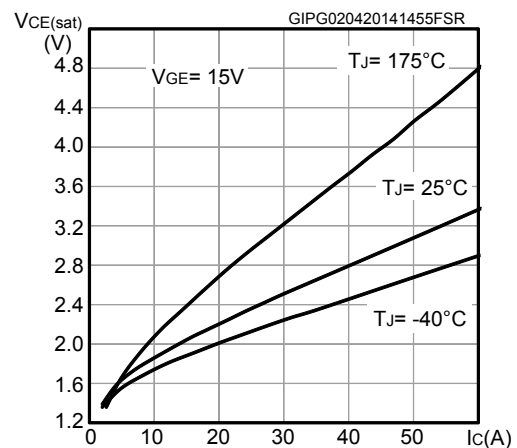
Figure 6. $V_{CE(sat)}$ vs collector current

Figure 7. Collector current vs switching frequency

Figure 8. Safe operating area

Figure 9. Transfer characteristics

Figure 10. Normalized $V_{GE(th)}$ vs junction temperature

Figure 11. Normalized $V_{(BR)CES}$ vs junction temperature

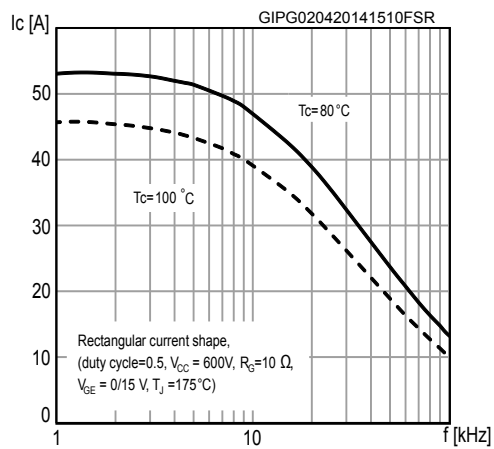
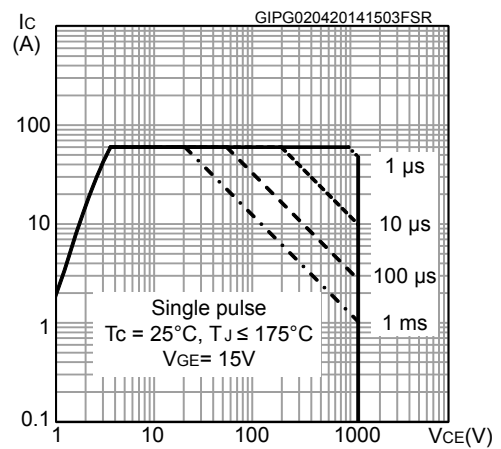
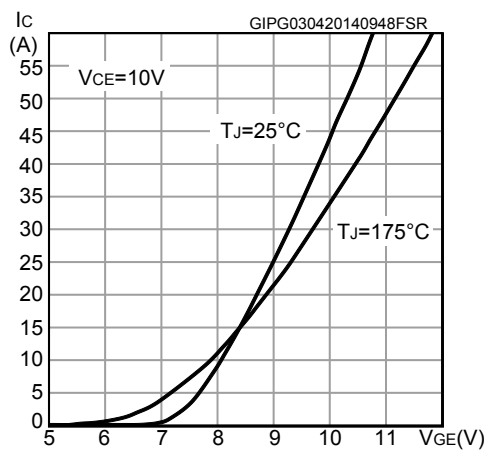
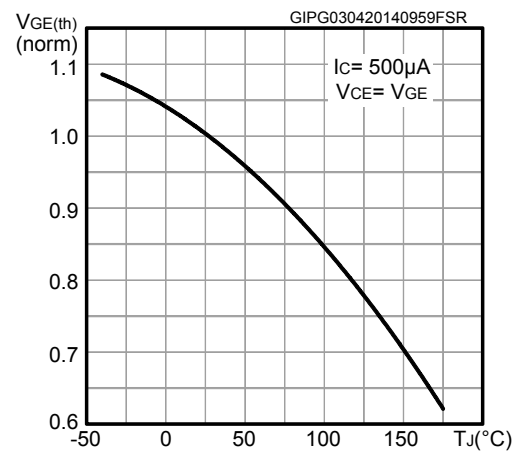
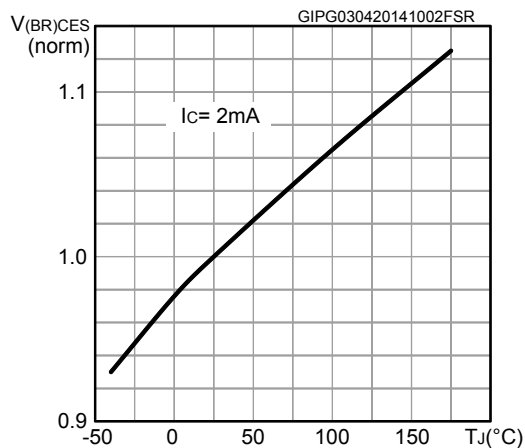
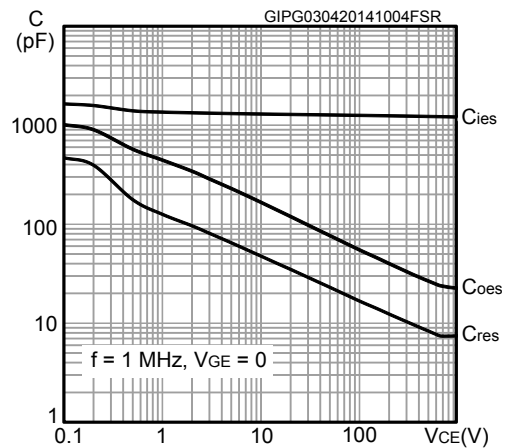
Figure 12. Capacitance variations

Figure 13. Gate charge vs gate-emitter voltage

Figure 14. Switching energy vs collector current

Figure 15. Switching energy vs gate resistance

Figure 16. Switching energy vs junction temperature

Figure 17. Switching energy vs collector-emitter voltage

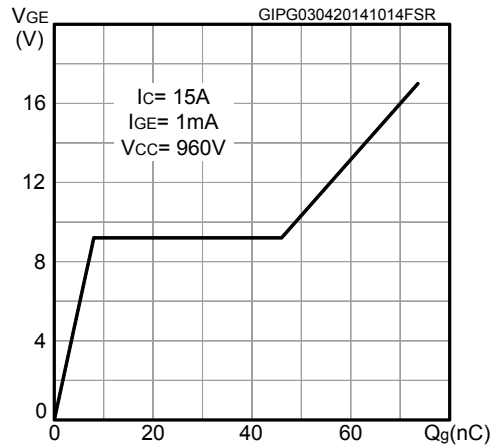
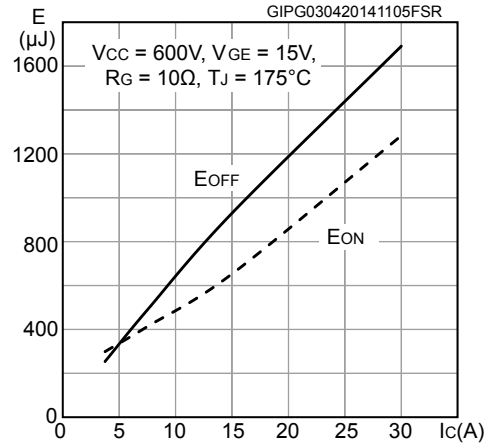
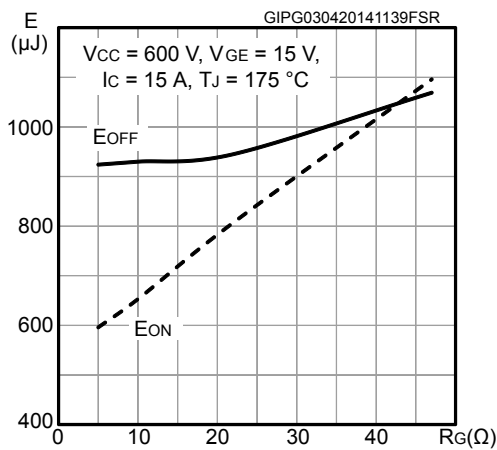
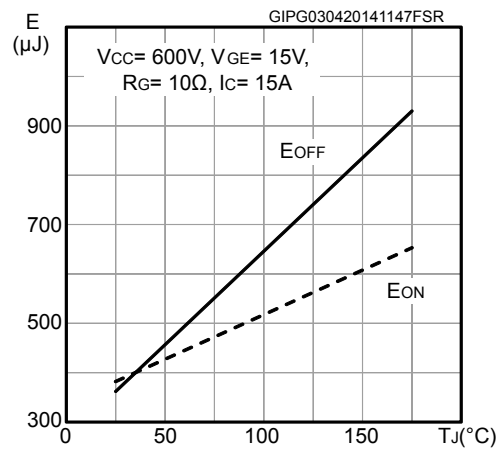
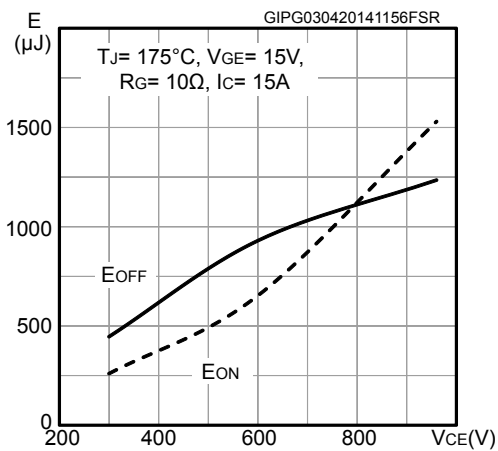
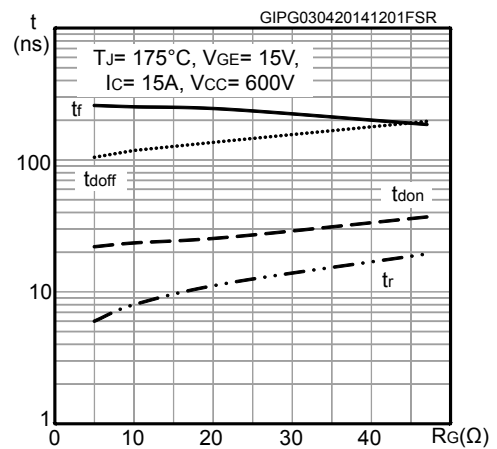
Figure 18. Switching times vs gate resistance

Figure 19. Switching times vs collector current

Figure 20. Diode V_F vs forward current

Figure 21. Reverse recovery current vs diode current slope

Figure 22. Reverse recovery time vs diode current slope

Figure 23. Reverse recovery charge vs diode current slope

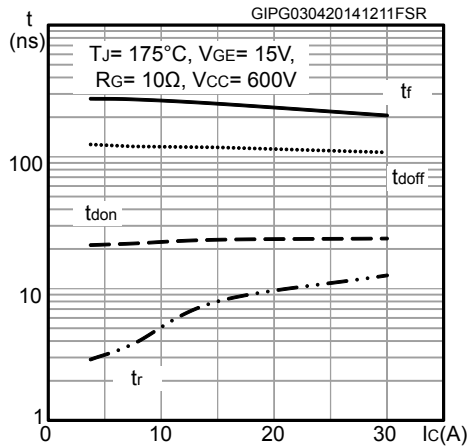
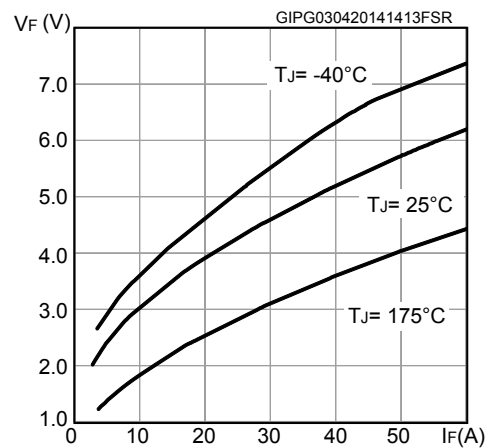
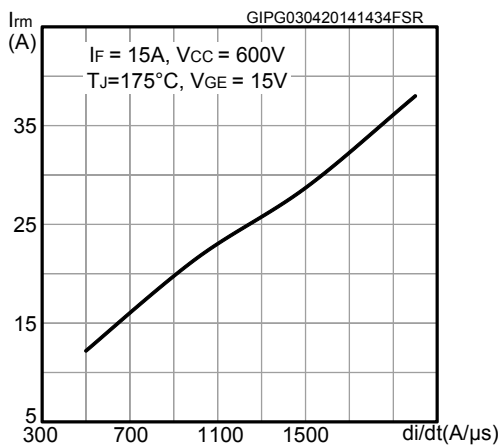
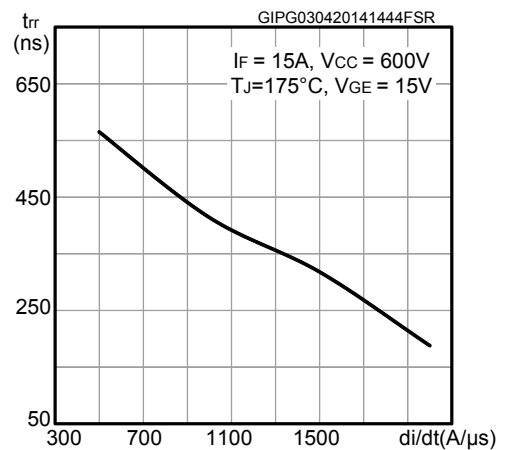
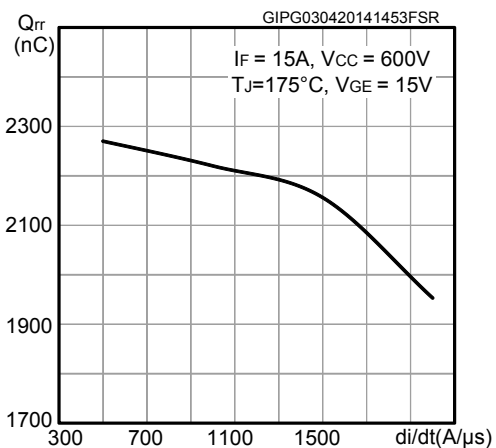
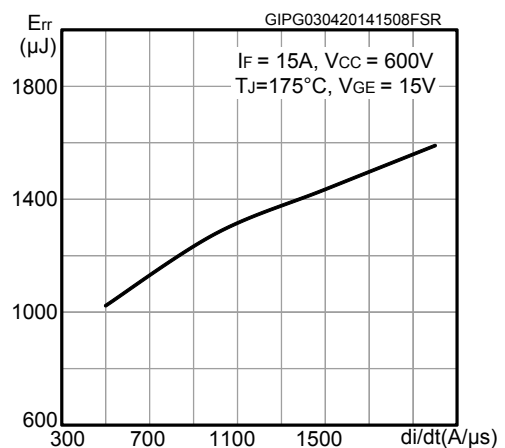
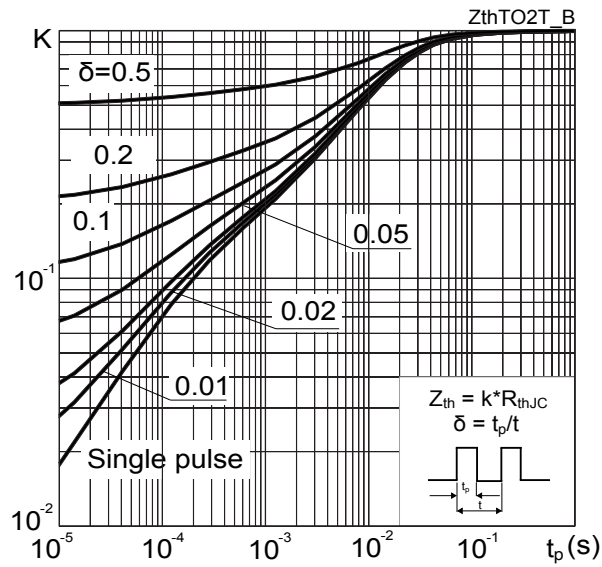
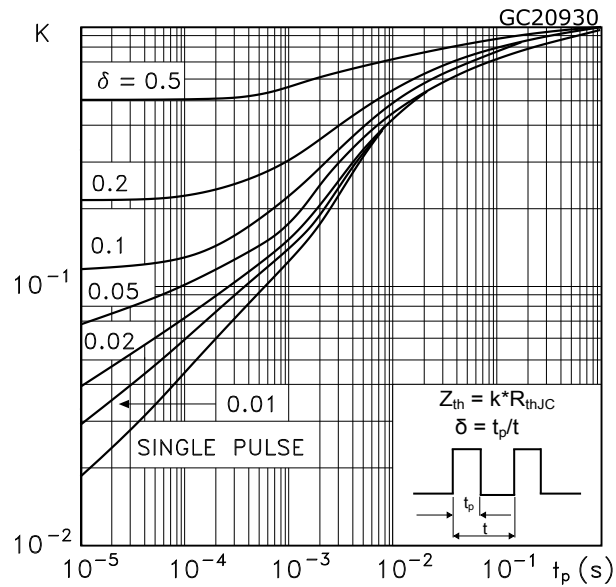
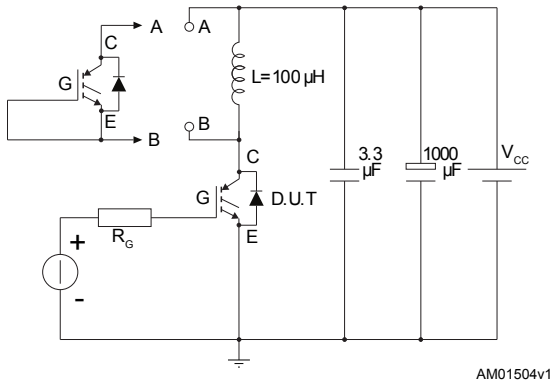
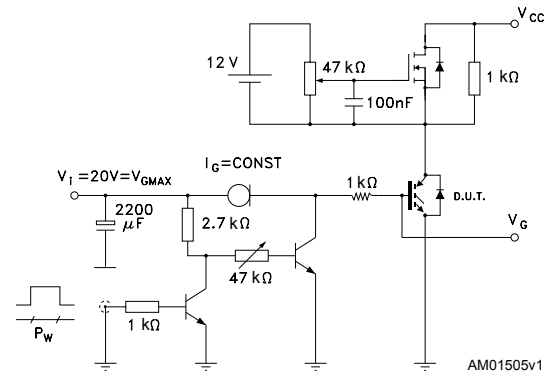
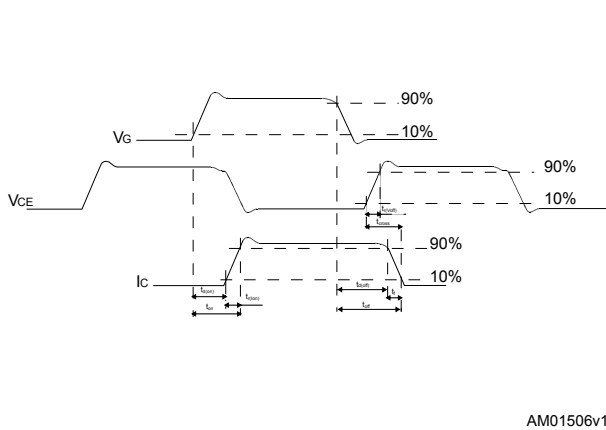
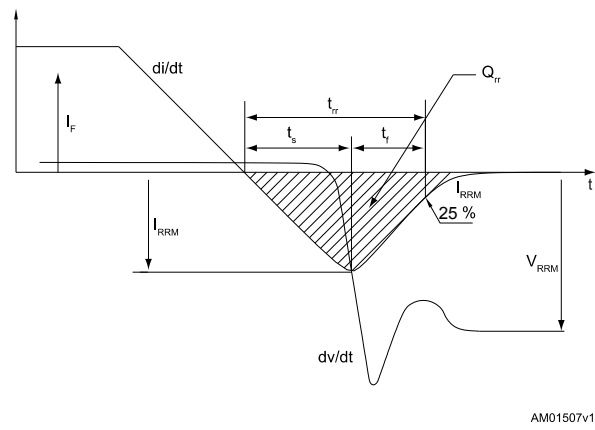
Figure 24. Reverse recovery energy vs diode current slope

Figure 25. Thermal impedance for IGBT

Figure 26. Thermal impedance for diode

3 Test circuits

Figure 27. Test circuit for inductive load switching

Figure 28. Gate charge test circuit

Figure 29. Switching waveform

Figure 30. Diode reverse recovery waveform

4 Package information

In order to meet environmental requirements, ST offers these devices in different grades of **ECOPACK** packages, depending on their level of environmental compliance. ECOPACK specifications, grade definitions and product status are available at: www.st.com. ECOPACK is an ST trademark.

4.1 TO-247 package information

Figure 31. TO-247 package outline

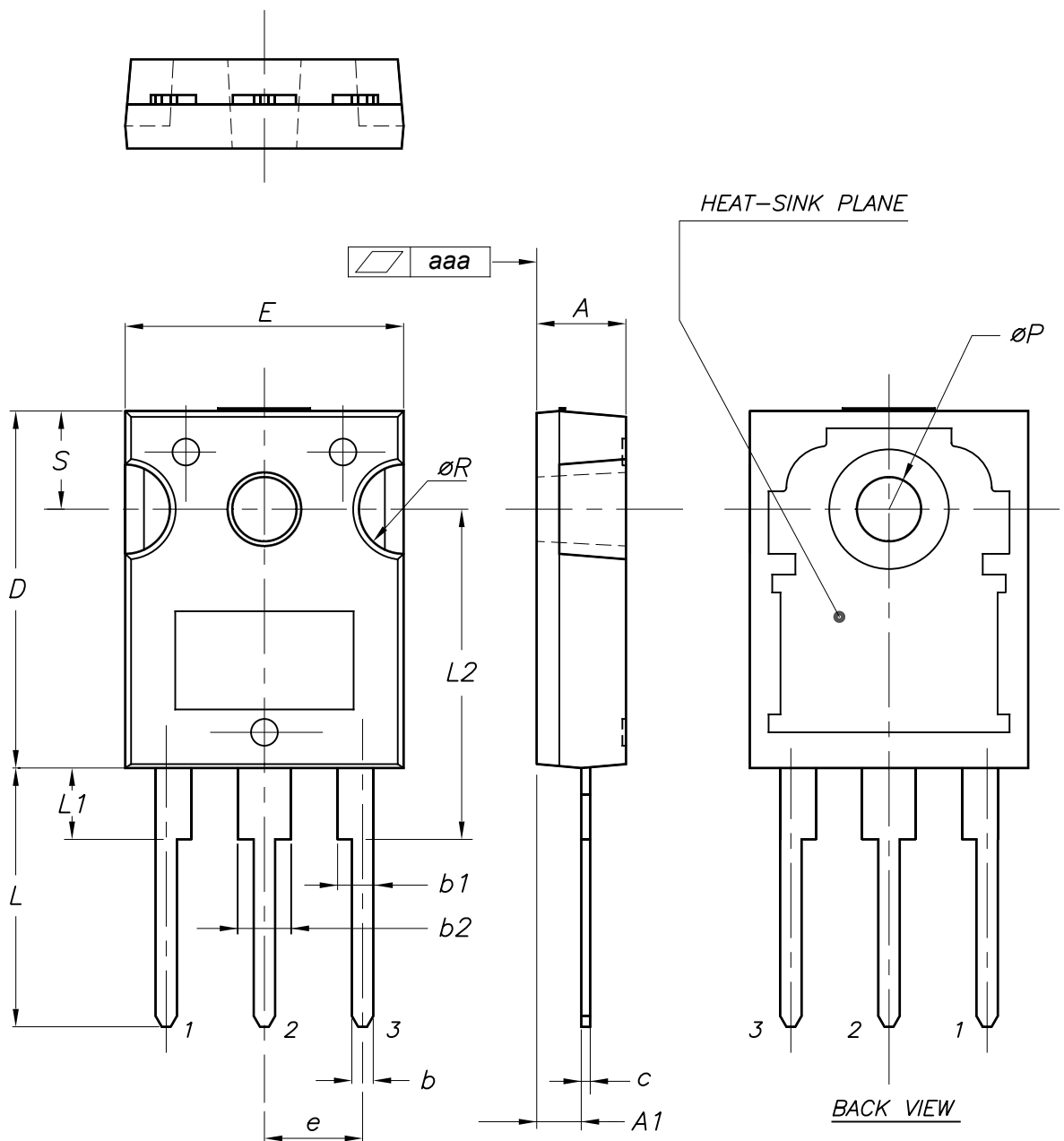
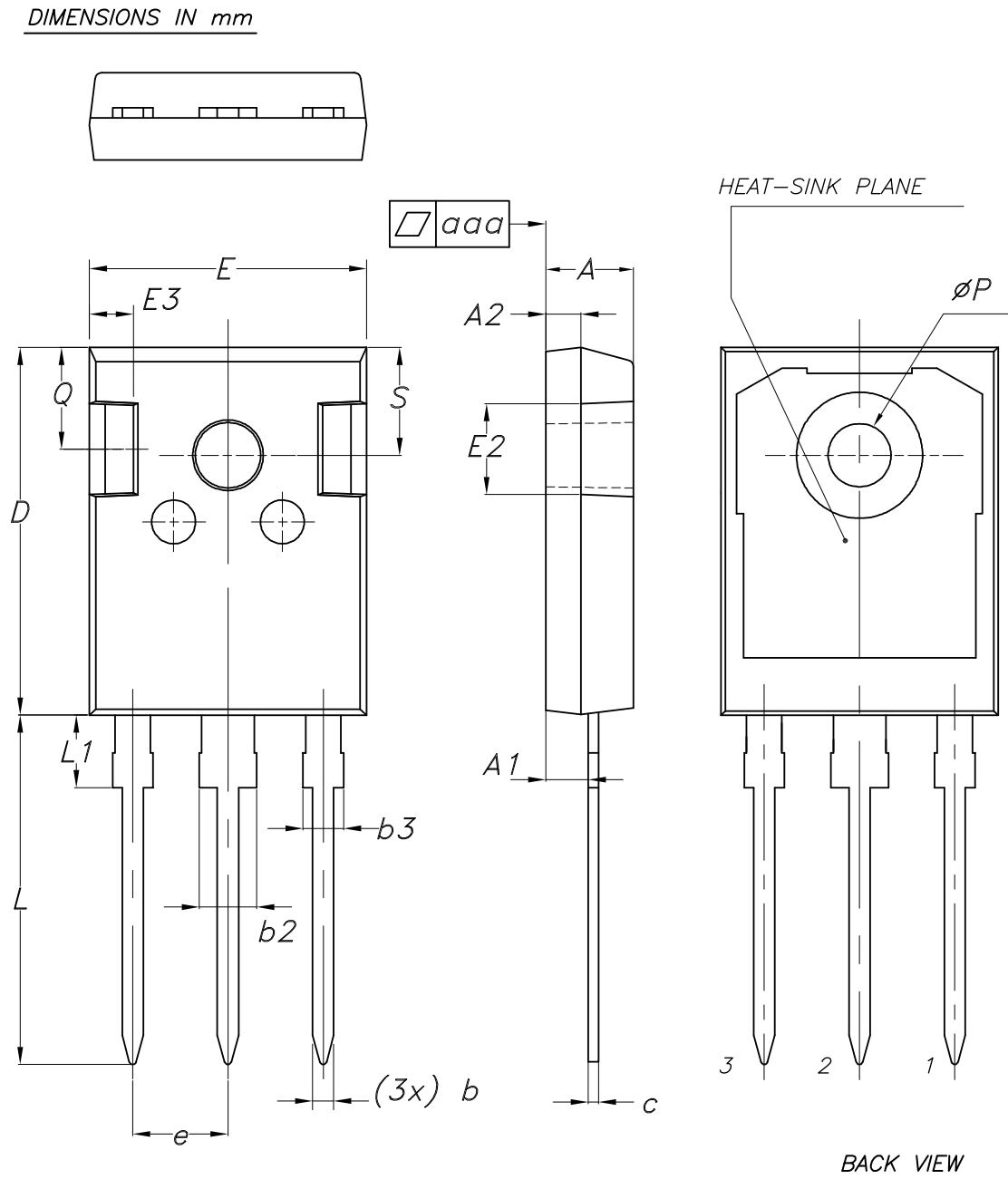

Table 7. TO-247 package mechanical data

Dim.	mm		
	Min.	Typ.	Max.
A	4.85		5.15
A1	2.20		2.60
b	1.0		1.40
b1	2.0		2.40
b2	3.0		3.40
c	0.40		0.80
D	19.85		20.15
E	15.45		15.75
e	5.30	5.45	5.60
L	14.20		14.80
L1	3.70		4.30
L2		18.50	
ØP	3.55		3.65
ØR	4.50		5.50
S	5.30	5.50	5.70
aaa		0.04	0.10

4.2 TO-247 long leads package information

Figure 32. TO-247 long leads package outline



8463846_3

Table 8. TO-247 long leads package mechanical data

Dim.	mm		
	Min.	Typ.	Max.
A	4.90	5.00	5.10
A1	2.31	2.41	2.51
A2	1.90	2.00	2.10
b	1.16		1.26
b2			3.25
b3			2.25
c	0.59		0.66
D	20.90	21.00	21.10
E	15.70	15.80	15.90
E2	4.90	5.00	5.10
E3	2.40	2.50	2.60
e	5.34	5.44	5.54
L	19.80	19.92	20.10
L1			4.30
P	3.50	3.60	3.70
Q	5.60		6.00
S	6.05	6.15	6.25
aaa		0.04	0.10

Revision history

Table 9. Document revision history

Date	Revision	Changes
03-Oct-2012	1	Initial release.
03-Mar-2014	2	Updated title and features in cover page. Updated <i>Section 4: Package mechanical data</i> . Minor text changes.
08-Apr-2014	3	Added <i>Section 2.1: Electrical characteristics (curves)</i> . Minor text changes.
29-Jan-2015	4	Added <i>4.2: TO-247 long leads, STGWA15H120DF2</i> . Updated <i>Figure 29.: Gate charge test circuit</i> . Updated <i>Figure 30.: Switching waveform</i> and <i>Figure 31.: Diode reverse recovery waveform</i> . Minor text changes.
04-Mar-2015	5	Updated <i>Figure 5.: Output characteristics (T_J = 175 °C)</i> Minor text changes.
08-Apr-2021	6	Updated <i>Table 1. Absolute maximum ratings</i> . Updated <i>Section 4 Package information</i> . Minor text changes.

Contents

1	Electrical ratings	2
2	Electrical characteristics	3
2.1	Electrical characteristics (curves)	5
3	Test circuits	10
4	Package information	11
4.1	TO-247 package information	11
4.2	TO-247 long leads package information	13
	Revision history	15

IMPORTANT NOTICE – PLEASE READ CAREFULLY

STMicroelectronics NV and its subsidiaries (“ST”) reserve the right to make changes, corrections, enhancements, modifications, and improvements to ST products and/or to this document at any time without notice. Purchasers should obtain the latest relevant information on ST products before placing orders. ST products are sold pursuant to ST’s terms and conditions of sale in place at the time of order acknowledgement.

Purchasers are solely responsible for the choice, selection, and use of ST products and ST assumes no liability for application assistance or the design of Purchasers’ products.

No license, express or implied, to any intellectual property right is granted by ST herein.

Resale of ST products with provisions different from the information set forth herein shall void any warranty granted by ST for such product.

ST and the ST logo are trademarks of ST. For additional information about ST trademarks, please refer to www.st.com/trademarks. All other product or service names are the property of their respective owners.

Information in this document supersedes and replaces information previously supplied in any prior versions of this document.

© 2021 STMicroelectronics – All rights reserved