

Reference Design:

HFRD-29.7

Rev. 1; 03/09

REFERENCE DESIGN

**Multirate (1Gbps to 10.3125Gbps) VCSEL
Small Form-Factor Pluggable (SFP+) Transceiver**

Multirate (1Gbps to 10.3125Gbps) VCSEL SFP+ Transceiver

Table of Contents

1	Overview.....	2
2	Obtaining Additional Information.....	2
3	Reference-Design Details	3
4	Transmitter Performance Data	5
5	Receiver Performance Data	9
6	Applications Information	15
7	Getting Started	16
8	SFP+ Evaluation Software	17
9	Signal Definitions	23
10	Component List.....	24
11	Schematic.....	25
12	Board Layout	26
13	Layer Profile	28

1 Overview

High-Frequency Reference Design (HFRD-29.7) is a complete optical transceiver targeted for the small form-factor pluggable (SFP+) Multisource Agreement (MSA) market and other high-speed optical-transceiver applications.

This design showcases the MAX3798 combination differential VCSEL driver and limiting amplifier. Data rates from 1Gbps to 10.3125Gbps are supported. The reference design is available with a variety of VCSEL (TOSAs) and receivers (ROSAs). Control of the MAX3798 is provided by an ATMEGA88 microprocessor. The microprocessor interfaces to the MAX3798 with a 3-wire digital interface, and is used to regulate optical power, monitor functions, and control other settings within the MAX3798. Communication with the SFP+ module is accomplished through the standard MSA I²C interface.

The MAX3798 is a cost-effective approach to providing an SFP+ multirate transceiver. Combining the VCSEL driver and limiting amplifier into a single 5mm x 5mm package reduces cost without compromising performance. Mask margins in excess of 40% at 10.3125Gbps are achievable. Good stressed receiver sensitivity performance has also been demonstrated.

The preliminary version of this reference design has also been featured in a detailed application

Reference Design HFRD-29.7 (Rev.1, 03/09)

note prepared by *SyntheSys Research* entitled, "Testing an SFP+ Transceiver to the 8X Fibre Channel Specification, Part I and II."

http://www.bertscope.com/Literature/Res_Acc/SFPplus_8GFC_Part1.pdf

https://tw21.market2lead.com/go/synthesysresearch/WS-WP-SFPplus_8GFC_Part2

The HFRD-29.7 transceiver reduces design time for SFP+ and other optical transmitters by providing the schematics, PC-board layout, Gerber files, and bill of materials for a complete SFP+ transceiver. The module is provided with some basic firmware and graphical user interface (GUI) to demonstrate the operation of the MAX3798. Test data and typical performance from an assembled board are also given to aid in evaluating this reference design.

1.1 Features

- Schematics and Bill of Materials provided
- Gerber plot files available
- Multirate (1Gbps to 10.3125Gbps)
- Single +3.3V power supply
- SFP+ multisource footprint
- Digital diagnostic monitors
- 850nm wavelength LC VCSEL (TOSA) and receiver (ROSA) provided
- Basic F/W and GUI provided with sample

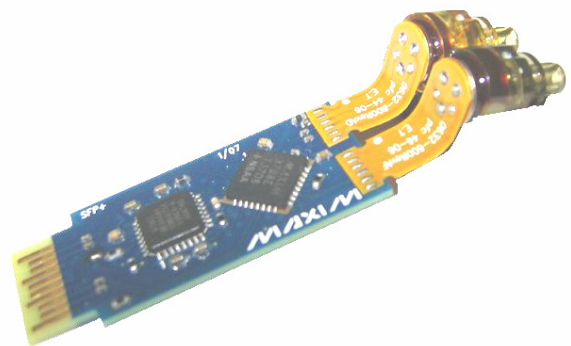

2 Obtaining Additional Information

Limited quantities of the HFRD-29.7 SFP+ transmitter board and HFRD-30.1 SFP host board

(see section 6.5) are available. For more information about this reference design or to obtain an SFP+ transmitter or host board, please access our customer support at: <https://support.maxim-ic.com/>

3 Reference-Design Details

3.1 Components

3.1.1 MAX3798 Laser Driver/Limiting Amp

The MAX3798 is a combination VCSEL driver and limiting amplifier with a 3-wire digital control interface. The driver portion has many registers and features, including:

1. Waveform peaking
2. Pulse-width fine adjustment
3. Control of bias and modulation
4. Soft and hard limits on bias and modulation
5. Driver back termination
6. Full differential drive
7. Up to 12mA modulation
8. Fault detection capability

The limiting amplifier features:

1. Adjustable-output CML level
2. Adjustable-output slew rate
3. Input-bandwidth select feature
4. Output pre-emphasis enable
5. 5mV input sensitivity
6. LOS polarity/squelch
7. Programmable LOS level

For additional information, see the MAX3798 data sheet available on the web at: www.maxim-ic.com/MAX3798.

3.1.2 Microcontroller

The microcontroller contains all of the firmware and input/output connections to control and monitor the MAX3798 functions. In this reference design an ATMEGA88 is employed, although other brands of microcontrollers can be used.

The microcontroller performs the following tasks:

1. I²C interface to host board
2. 3-wire digital interface to the MAX3798

3. Monitor and control of VCSEL power
4. Diagnostic monitoring functions
5. Control of all MAX3798 registers
6. Fault monitoring

Basic firmware is provided in the microcontroller to demonstrate the capability of the MAX3798. However, it is the designer's responsibility to complete a production version of the firmware. A GUI is also provided.

3.1.3 VCSEL (TOSA)

HFRD-29.7 is available with one of three VCSEL brands:

JDSU™ PL-FLD-00-S40-C5 www.jdsu.com

Emcore®: 8585-3760 www.emcore.com

Finisar®: HFE6192-261 www.finisar.com

All VCSELs are provided with flex circuit interconnect and packaged in LC headers.

3.1.4 Receive Optical Subassemblies (ROSA)

HFRD-29.7 can be provided to the customer with either of these ROSA brands:

Finisar: HFD6180-418 or HFD6180-419

JDSU: PL-FLR-00-S43-C6

3.2 Functional Block Diagram

The functional block diagram is shown in Figure 1. The 20-pin SFP+ electrical interface is shown on the left portion of the diagram. The TOSA and ROSA are located to the right of the MAX3798. A simple, but effective, RC equalizer is included on the Tx data input lines to help compensate for the jitter added by the edge connector. The TX DISABLE and TX FAULT functions are controlled through the microcontroller.

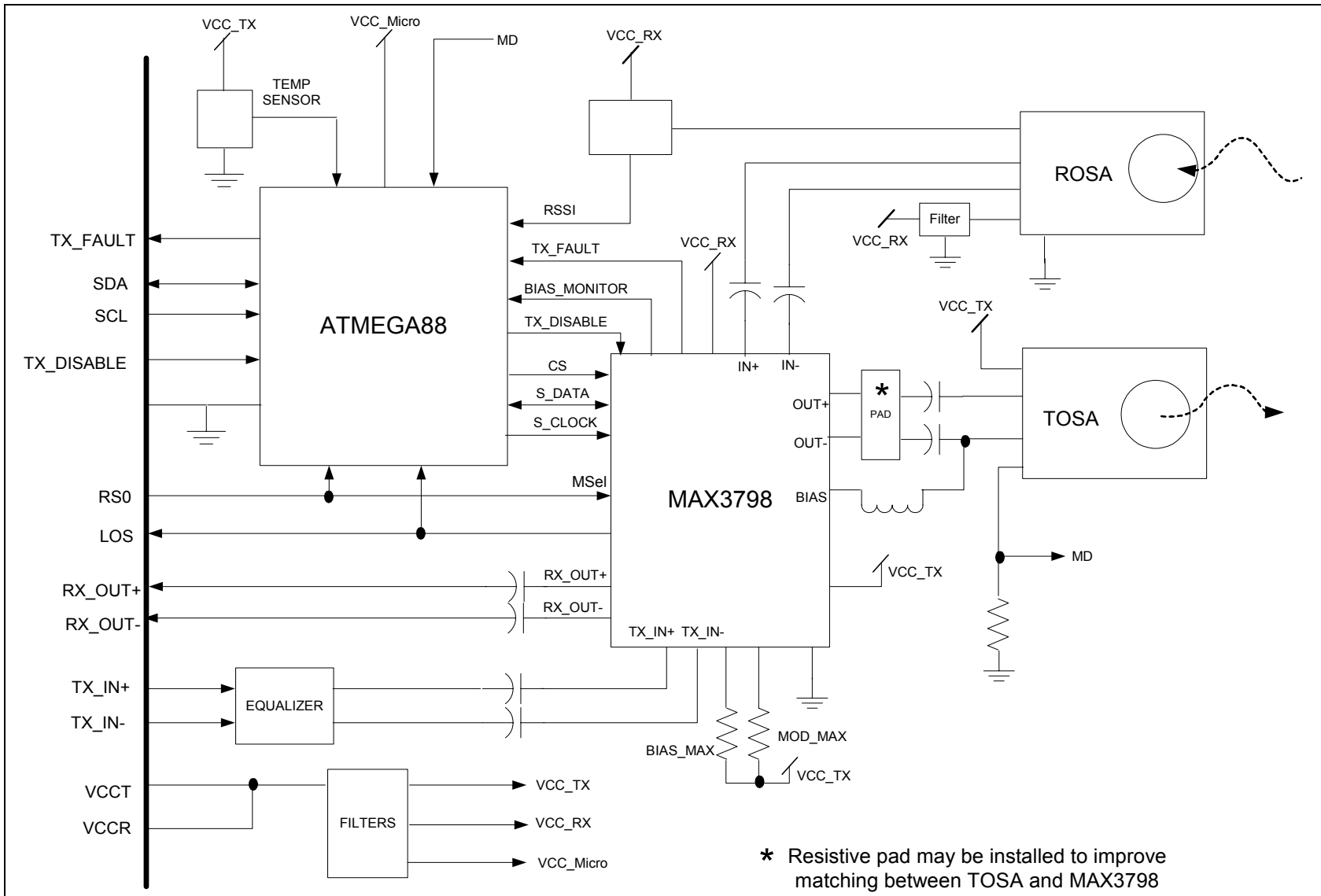
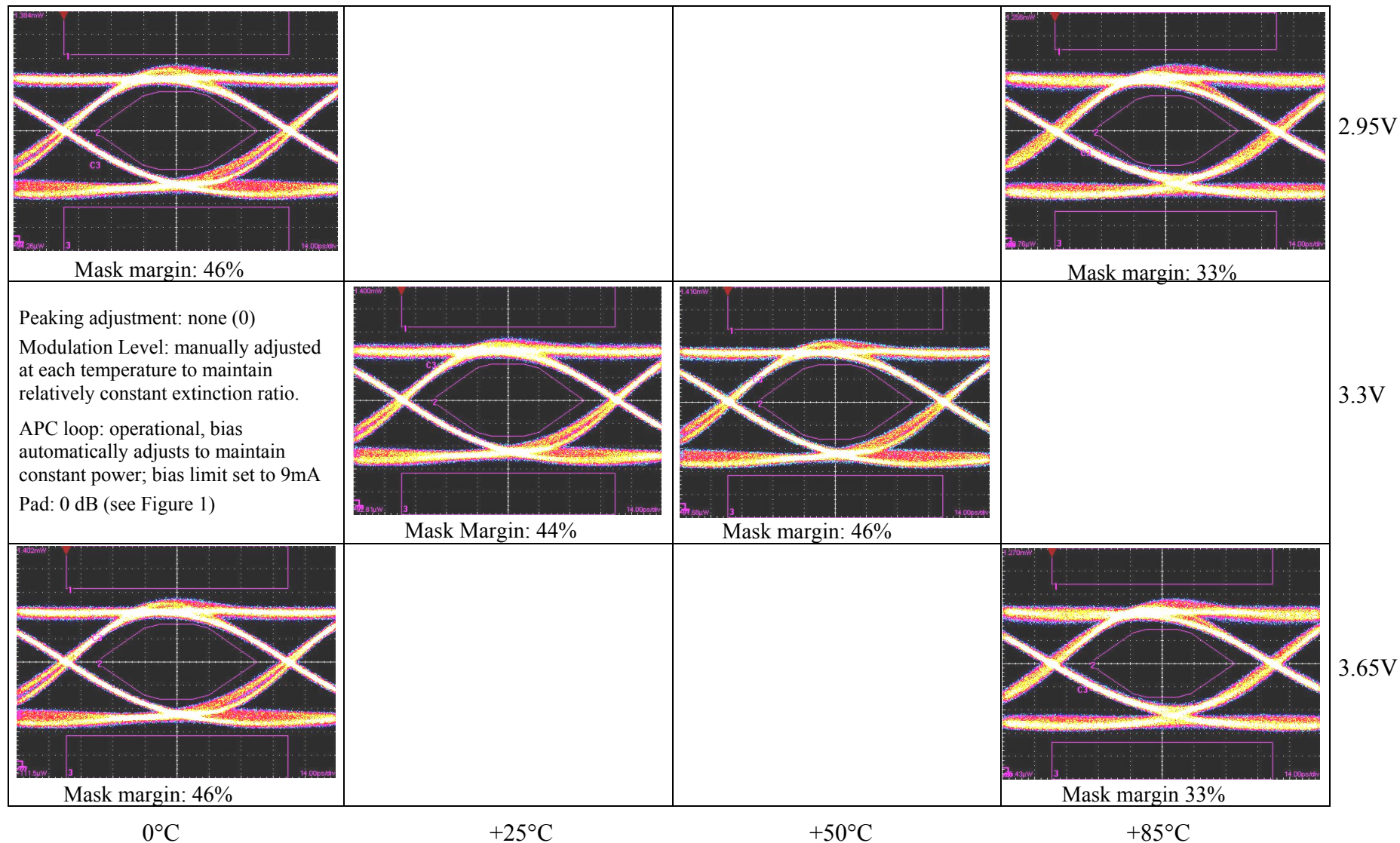

Figure 1. Functional diagram.

4 Transmitter Performance Data

4.1 Filtered Transmit Eye Diagrams at 10.3125Gbps, PRBS 2³¹-1, (JDSU VCSEL shown)



4.2 Filtered Transmit Eye Diagrams at 10.3125Gbps vs. Temperature (Finisar and Emcore VCSELS shown)

Finisar VCSEL

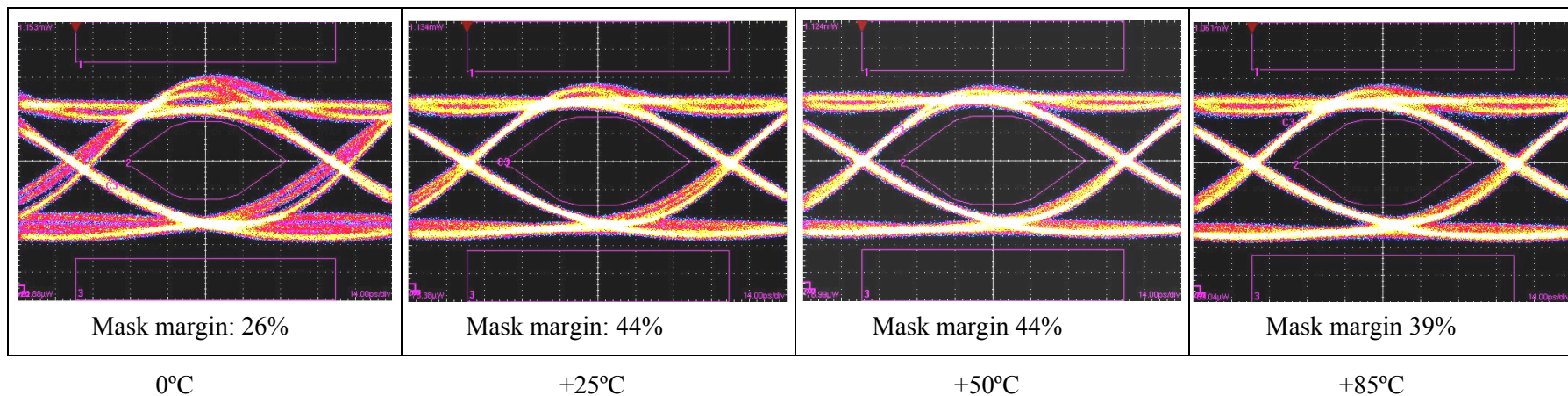

Peaking adjustment: none (0) Pad: 4dB Modulation level: manually adjusted to maintain relatively constant extinction ratio

Emcore VCSEL

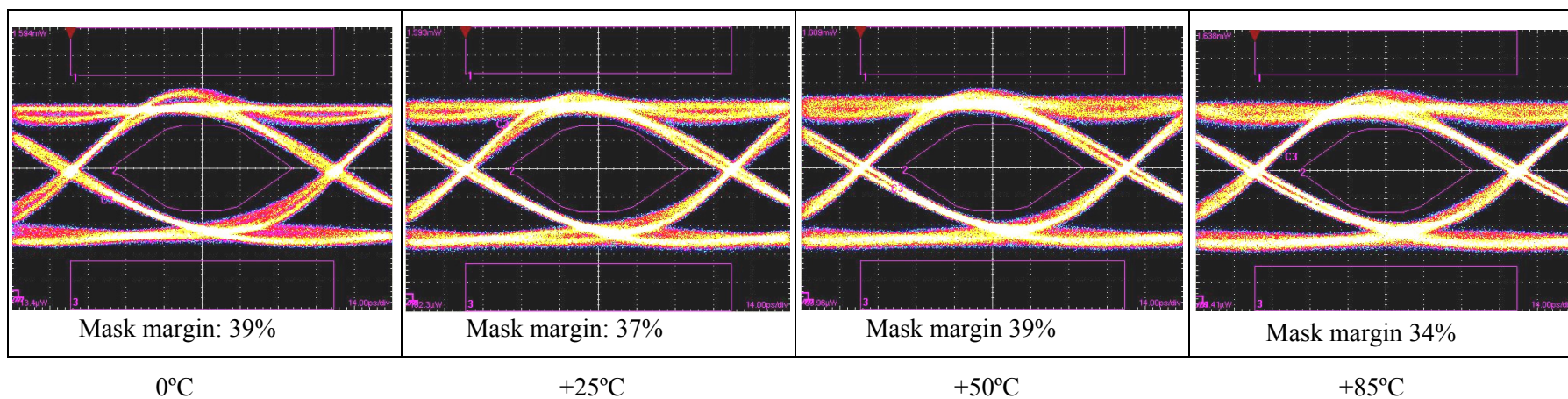

Peaking adjustment: none (0) Pad: 4dB Modulation level: manually adjusted to maintain relatively constant extinction ratio

4.3 Additional Transmitter Data (shown for the Finisar VCSEL)

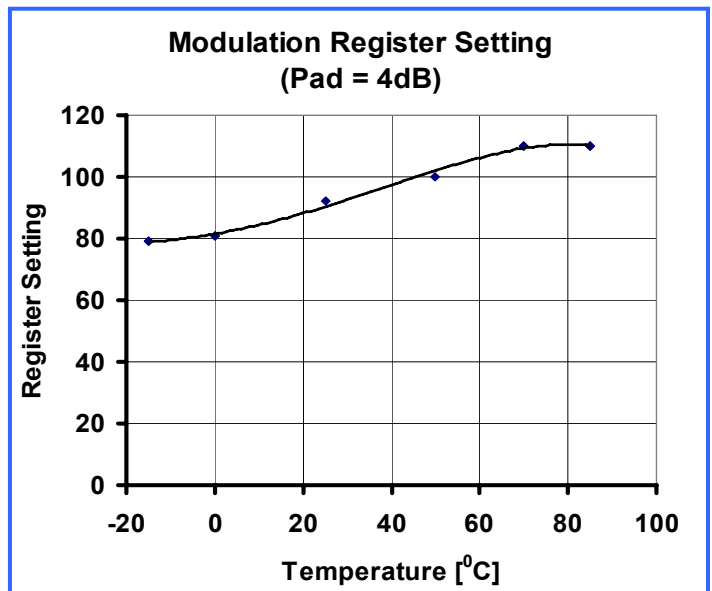
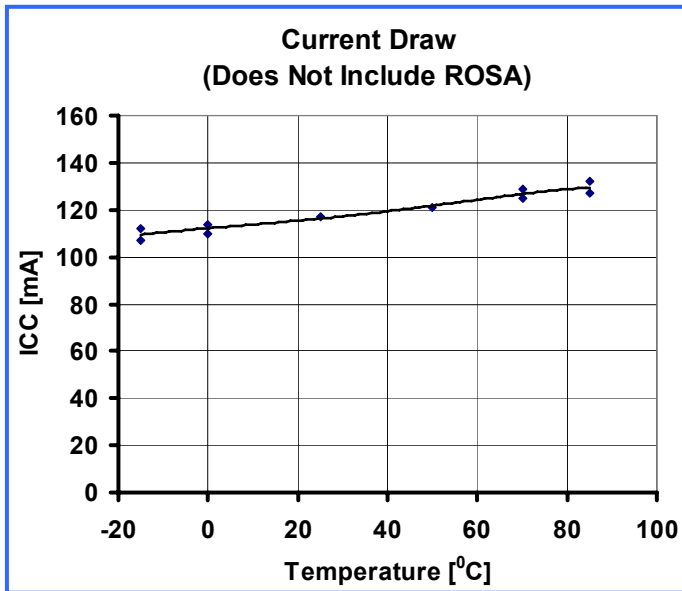
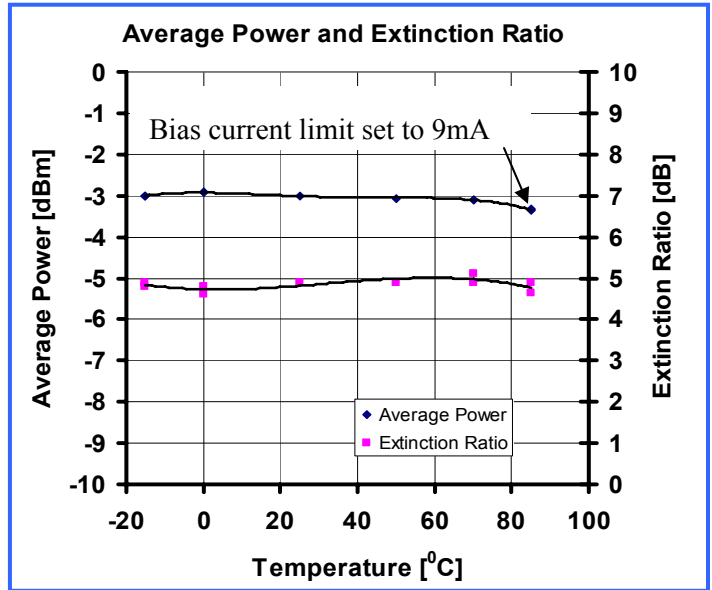
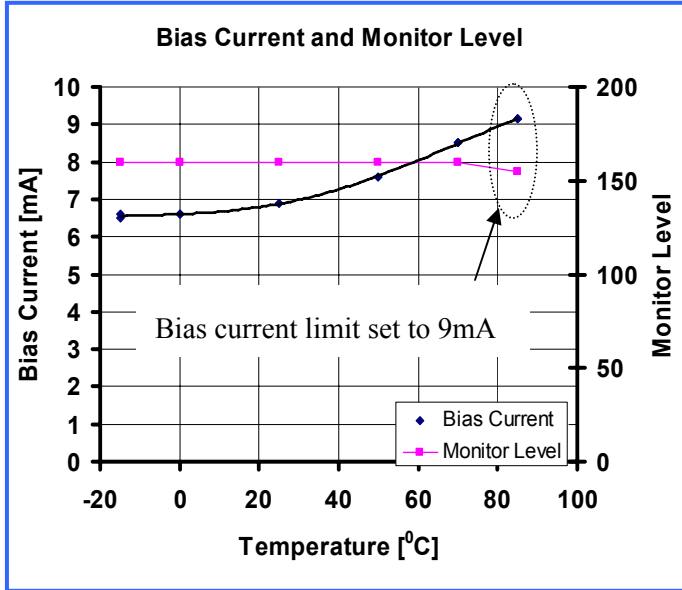

4.4 Filtered Transmit Eye Diagrams at Lower Data Rates (JDSU VCSEL shown)

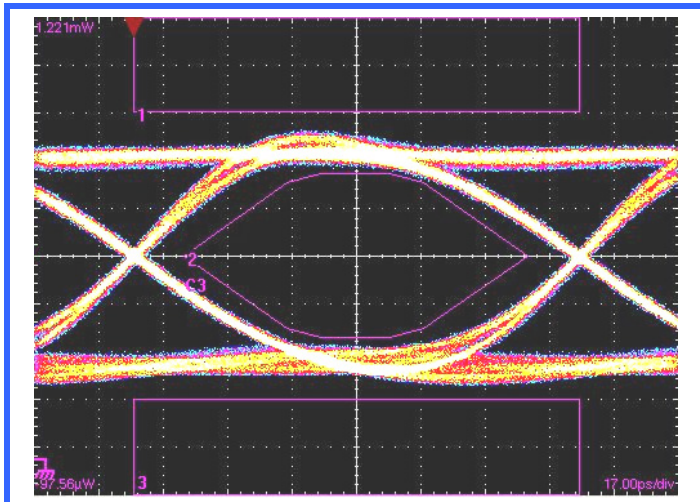

8.5Gbps (2^7-1 PRBS)

Mask margin: 54%

Average power: -2.7dBm

Extinction ratio: 5dB

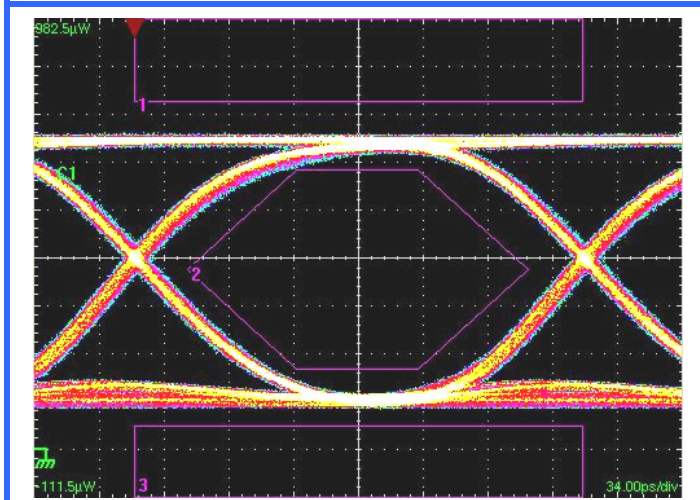

4.25Gbps (2^7-1 PRBS)

Mask margin: 46%

Average power: -3.9dBm

Extinction ratio: 7.9dB

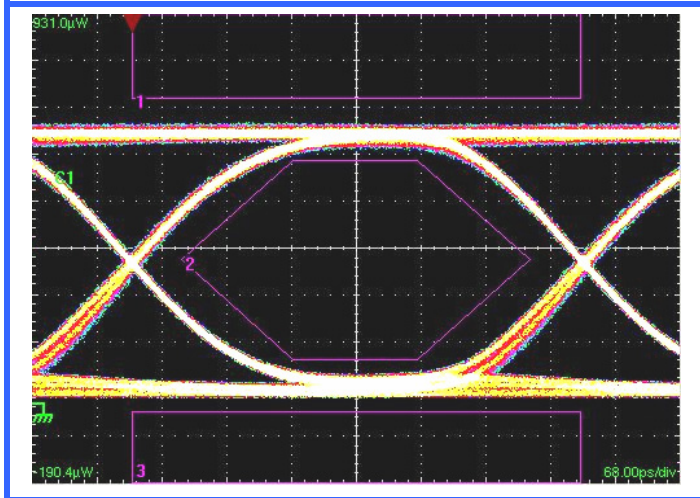

2.125Gbps (2^7-1 PRBS)

Mask margin: 50%

Average power: -4.7dBm

Extinction ratio: 12dB

5 Receiver Performance Data

5.1 Receiver Output Eye Diagrams at 10.3125Gbps, 2³¹-1 PRBS, -11dBm Input OMA, Nonstressed Source

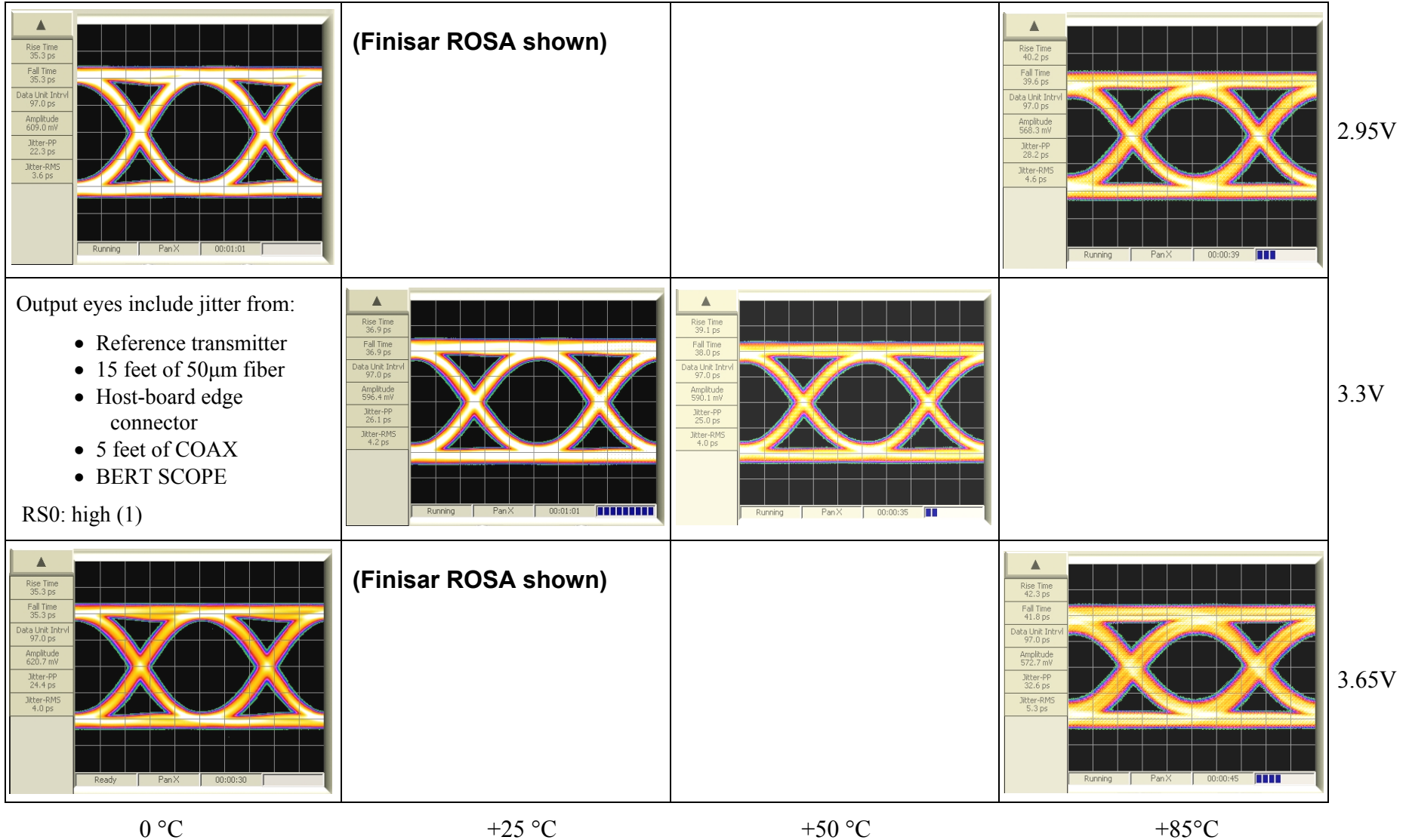

5.2 Receiver Sensitivity, 10.3125Gbps, Nonstressed, (Finisar ROSA shown)

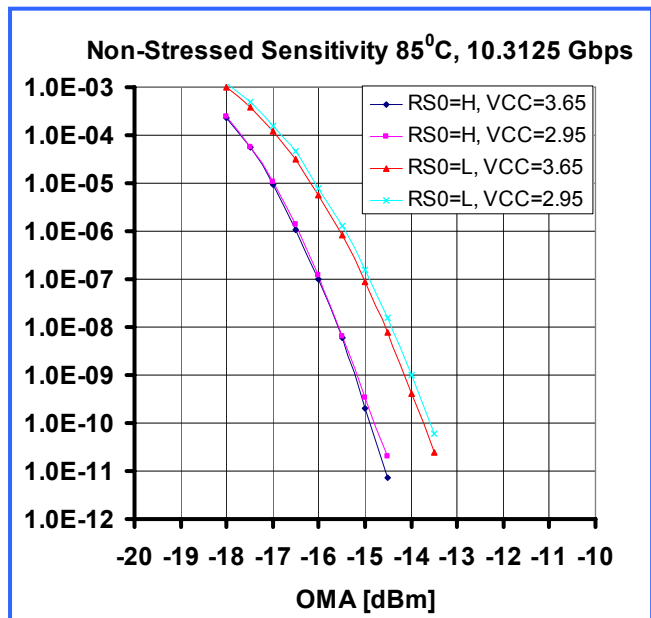
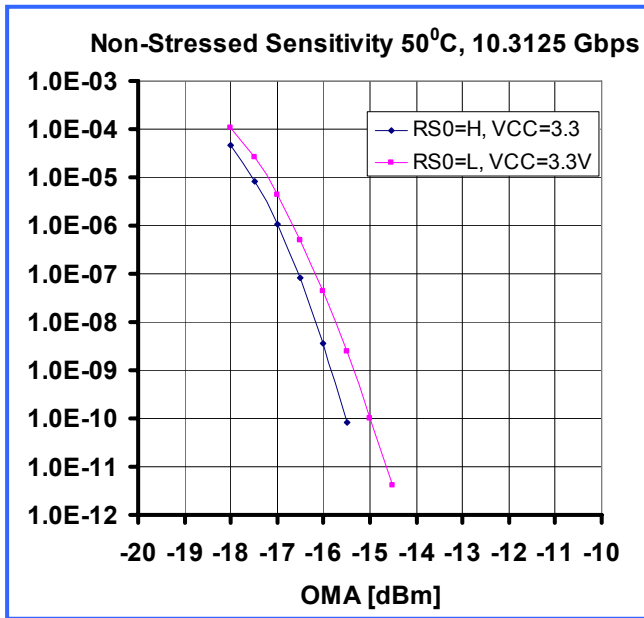
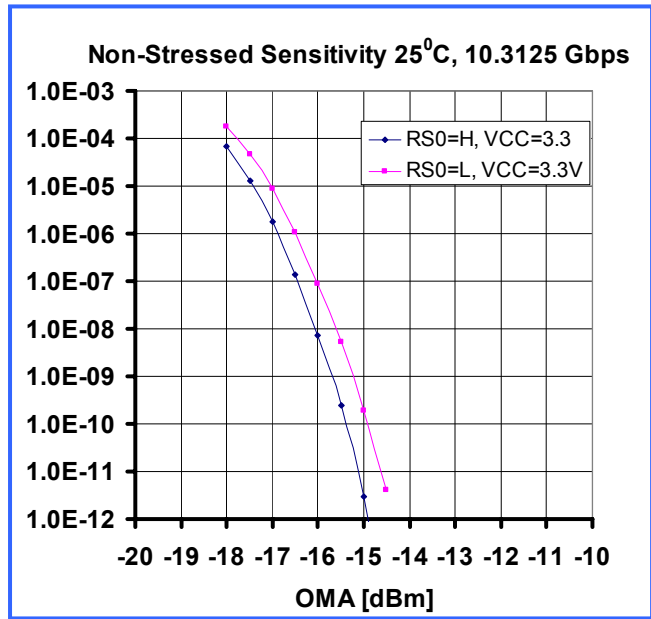
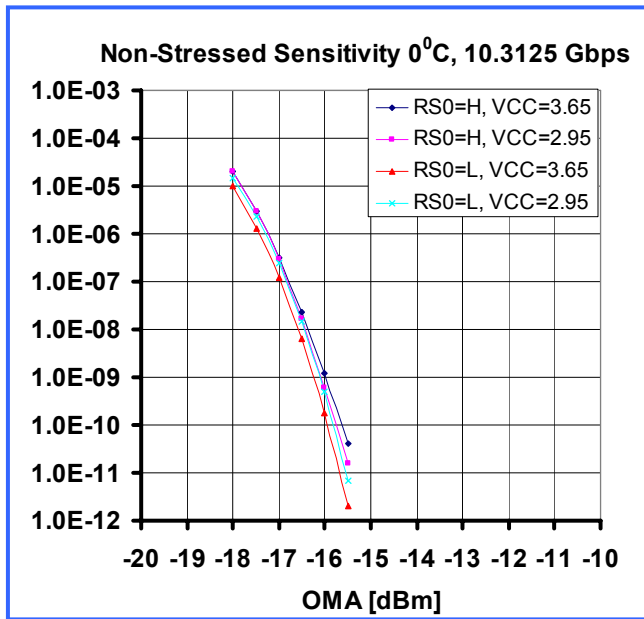

Data pattern: $2^{31}-1$ PRBS

5.3 Stressed Receiver Sensitivity, 10.3125Gbps and 8.5Gbps

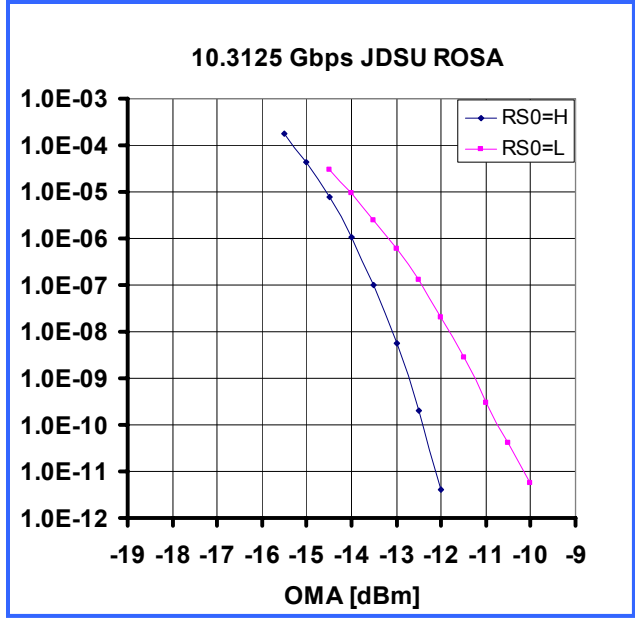
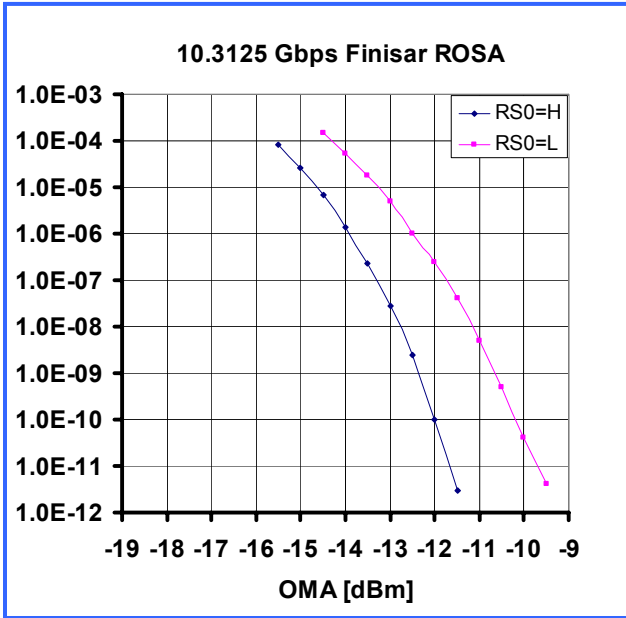

Data pattern: $2^{31}-1$ PRBS

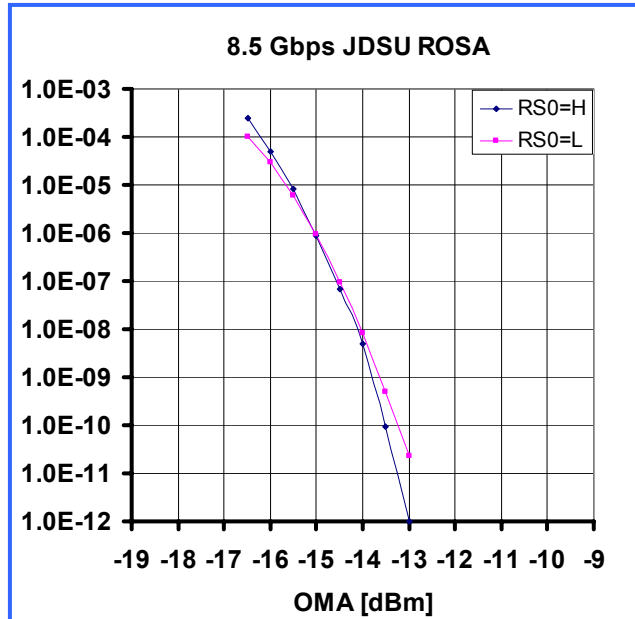
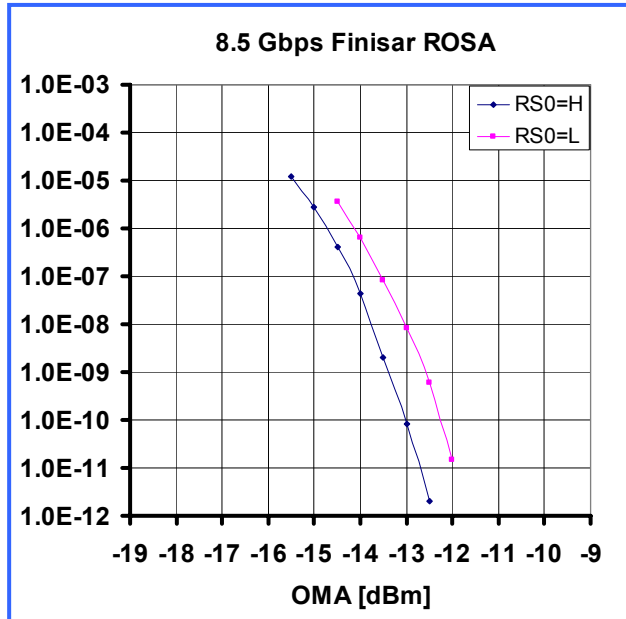

Data pattern: 2^7-1 PRBS

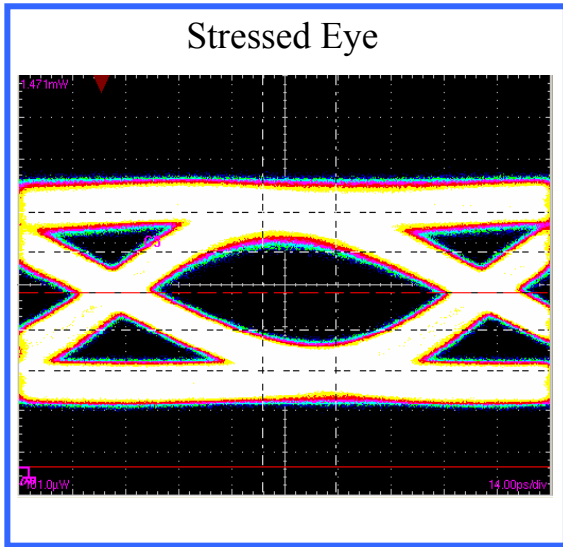

Optical stressed eye input to HFRD-29.7
(2^{31} -1PRBS, -7.5dBm)

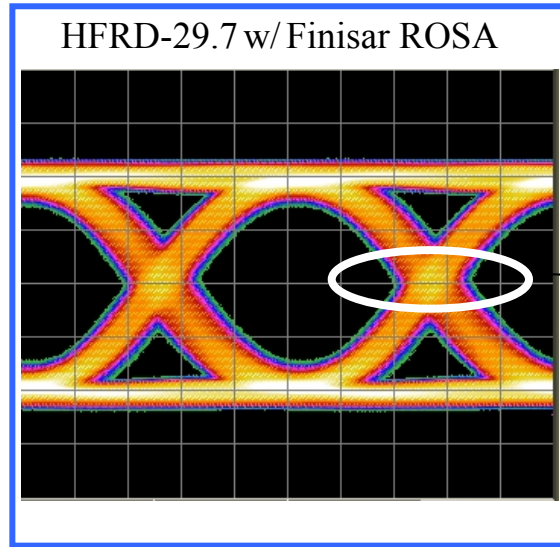

HFRD-29.7 output
(RS0 = H, De-emphasis = On)

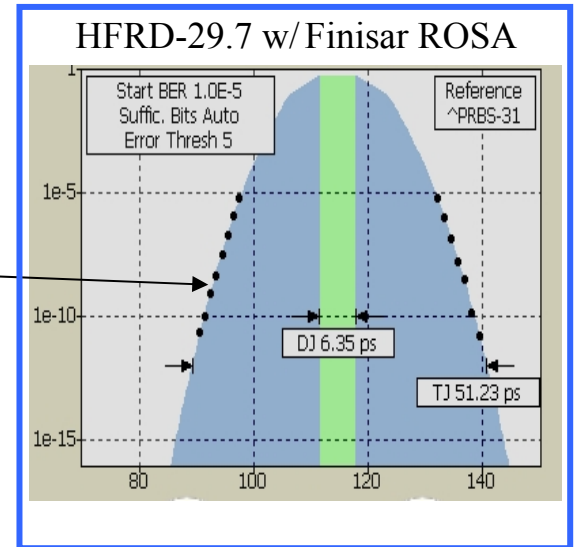

Jitter bath-tub curve

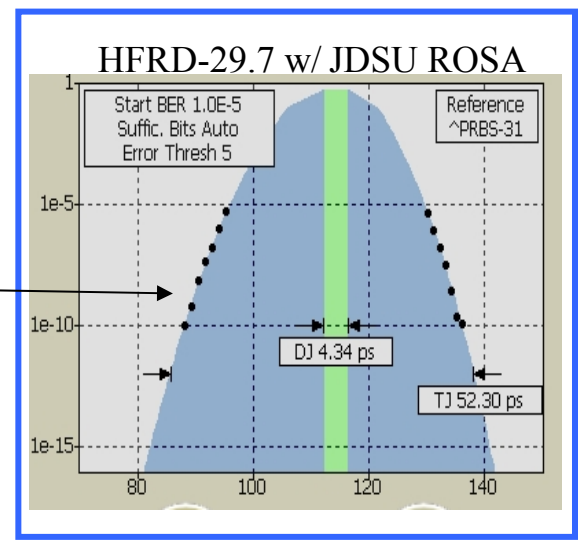
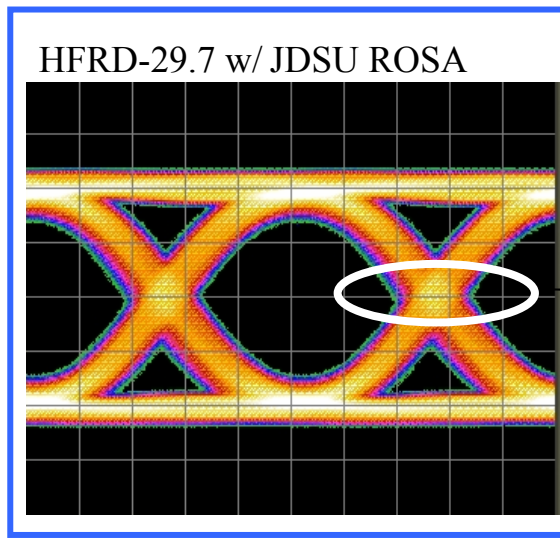
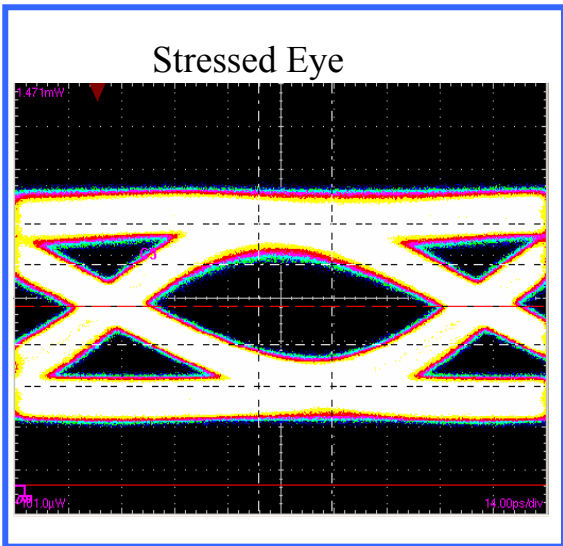

5.4 Receiver Sensitivity, Lower Data Rates, nonstressed

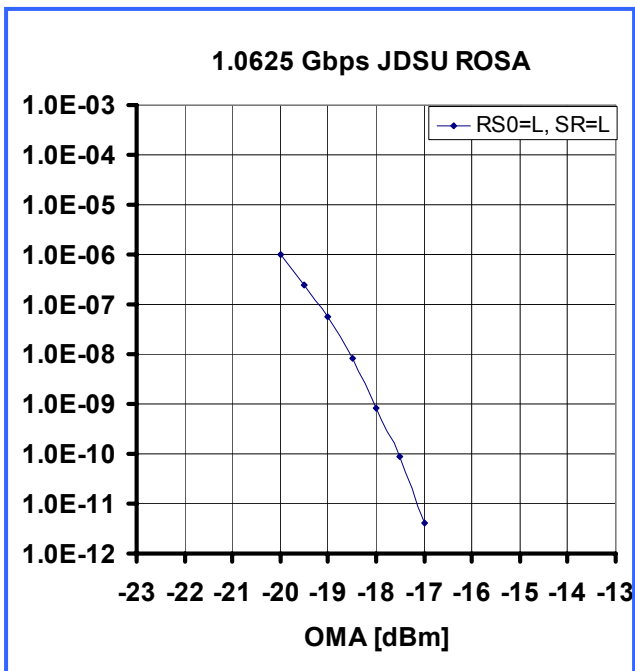
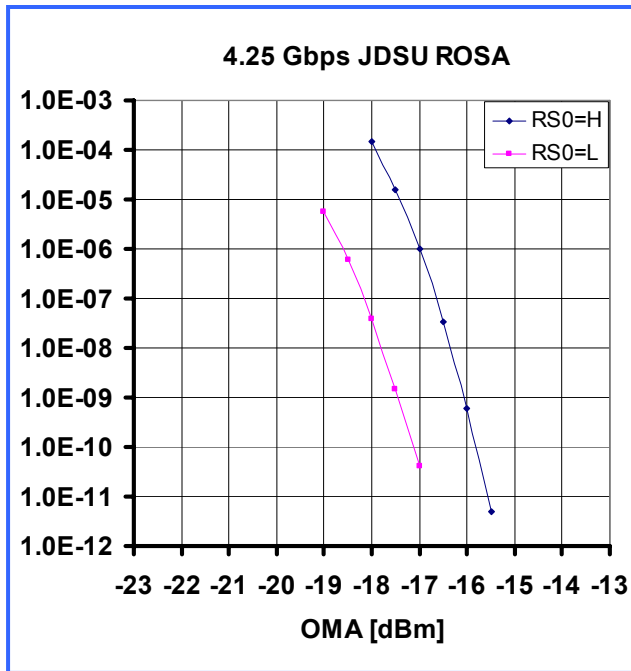
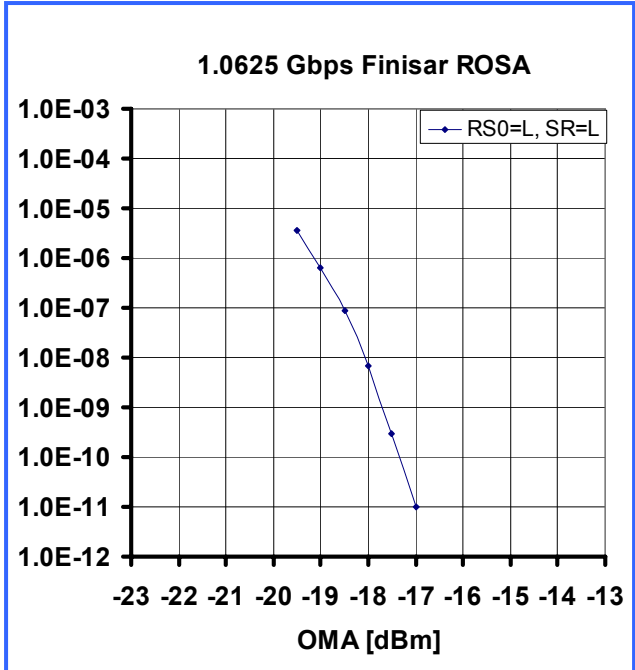
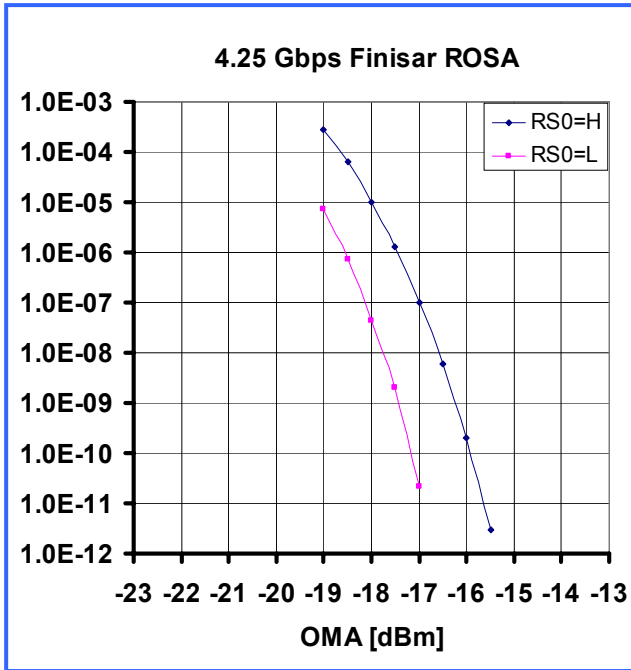

Data pattern: 2^7-1 PRBS

5.5 Receiver LOS and RSSI, Finisar ROSA, 10.3125Gbps

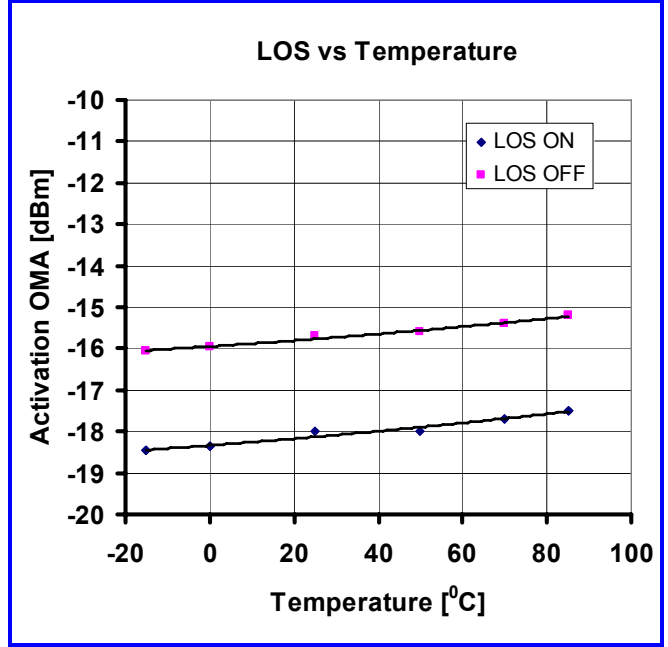
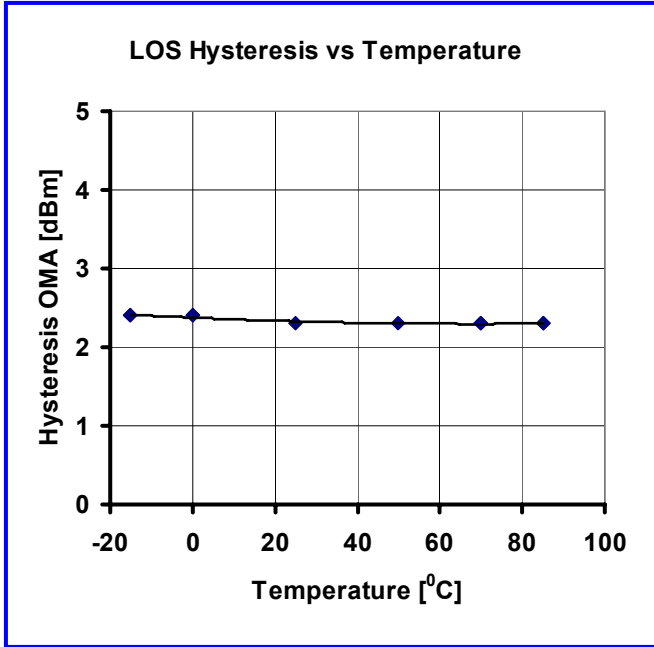

LOS level: 63 (Decimal); VCC: 3.3V

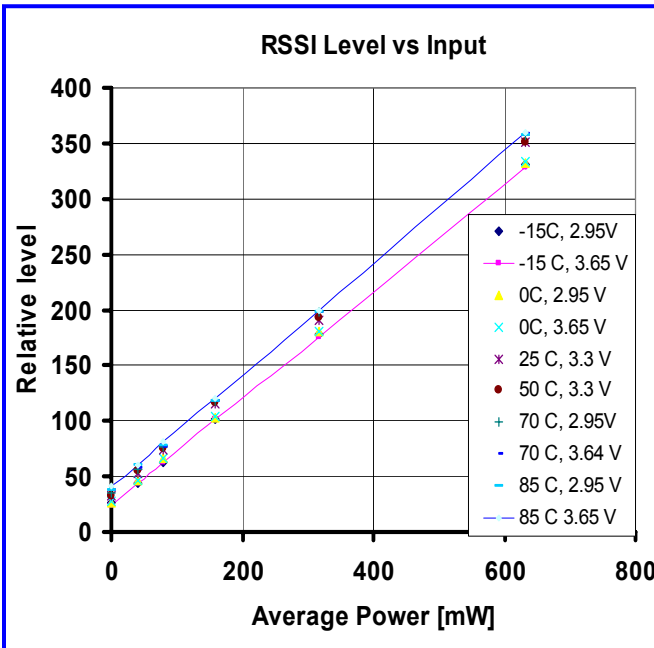

6 Applications Information

6.1 Small Form-Factor Pluggable Transceivers

The HFRD-29.7 transceiver design was specifically engineered to meet the requirements of the small form-factor pluggable (SFP+) Transceiver Multisource Agreement (MSA). This MSA sets guidelines for the package outline, pin function, and other aspects of the module design. By complying with the standard, modules are mechanically and functionally interchangeable.

6.2 Monitor Functions

HFRD-29.7 provides monitor outputs for RSSI, bias current, temperature, VCC, and VCSEL monitor diode power level. The uncalibrated data is displayed in the Maxim-supplied GUI discussed below. To convert to an internally-calibrated format, the user can write additional microcontroller code to perform this function.

6.3 Microcontroller Firmware

This reference design is provided with basic microcontroller firmware. The firmware contains the following functions:

- Automatic power control (APC)
- Tx disable
- Tx fault indicator
- LOS indicator
- Uncalibrated monitor outputs
- I²C connection to host
- 3-wire interface to MAX3798

Additional code will be required to make the unit fully MSA compliant. It is the responsibility of the module designer to ensure that the code has been thoroughly reviewed. Maxim can provide a copy of the basic firmware used in the design to serve as a general guideline for implementing the APC control function and 3-wire interface.

6.4 Layout Considerations

Differential and single-ended transmission lines are designed on the HFRD-29.7 PC board. Changing the PCB layer profile can affect the impedance of these transmission lines and the performance of the reference design. If the layer profile is changed, the transmission line dimensions should be recalculated. Additional details are provided in sections 12 and 13.

6.5 Host-Board Requirements

To fully evaluate the HFRD-29.7, a Maxim Host Board HFRD-30.1 is recommended. The HFRD-30.1 provides: the controlled impedance interface between the reference design and user's high-speed test equipment such as the oscilloscope; and the Bit Error Ratio Tester (BERT). In addition, the host board permits the user to run the Maxim-provided GUI software through a standard USB connection. More details on this are provided in section 7 titled, "Getting Started."

6.6 Operating Data Rates

The HFRD-29.7 is specified to operate at data rates ranging from 1.0625Gbps (8B10B coding) up to 10.3125Gbps (64/66 coding). The output power and extinction ratio for the optical signal are dependent on the data rate selected. When a module sample is shipped to a customer, it is configured for the highest data rate. The extinction ratio is set in the range of 4.5dB to 5dB. Optical power is set in the range of -1dBm to -3dBm. The customer can test the part at lower data rates, but will need to adjust the modulation and APC levels for the desired extinction ratio and output power.

6.7 Operating Temperature

The operating temperatures of the MAX3798, is from -40°C to +85°C. The recommended operating temperature of the TOSAs and ROSAs varies from one manufacturer to the next. Maximum VCSEL case temperature is generally specified as +85°C. Minimum VCSEL case temperature varies from -40°C to 0°C. The suggested operating temperature range for the HFRD-29.7 is 0°C to +85°C.

6.8 Gerber Files

The Gerber files for this reference design are available by contacting Maxim support at 800-988-9872 between 8 a.m. and 5 p.m. Pacific Time or access our customer support through the web site at: <https://support.maxim-ic.com/>. While Gerber files can be provided, it is still the module designer's responsibility to ensure that the layout meets all of their mechanical and thermal requirements.

6.9 TOSA and ROSA Options

At the time of this publication, there are three TOSA options and two ROSA options for HFRD-29.7. These options are outlined in sections 3.1.3 and 3.1.4. When a sample request is made, the customer should indicate which TOSA and ROSA are required. At special request, Maxim may also install a customer's custom TOSA or ROSA, provided that they meet the correct mechanical and electrical specifications.

7 Getting Started

The HFRD-29.7 can be evaluated on any host board. However, to utilize the added benefit of the Maxim-supplied GUI, Maxim's host board HFRD30.1 is recommended. (Please refer to Reference Design HFRD30.1 for complete details on the host board.) http://www.maxim-ic.com/products/optical/reference_designs/

Figure 2 shows the host board and associated connections. Precautions must be taken to ensure safe operation when using a device with a laser diode. Laser-light emissions can be harmful and may cause eye damage. Maxim assumes no responsibility for harm or injury as a result of the use of this reference design. The safe operation of this design is the sole responsibility of the user.

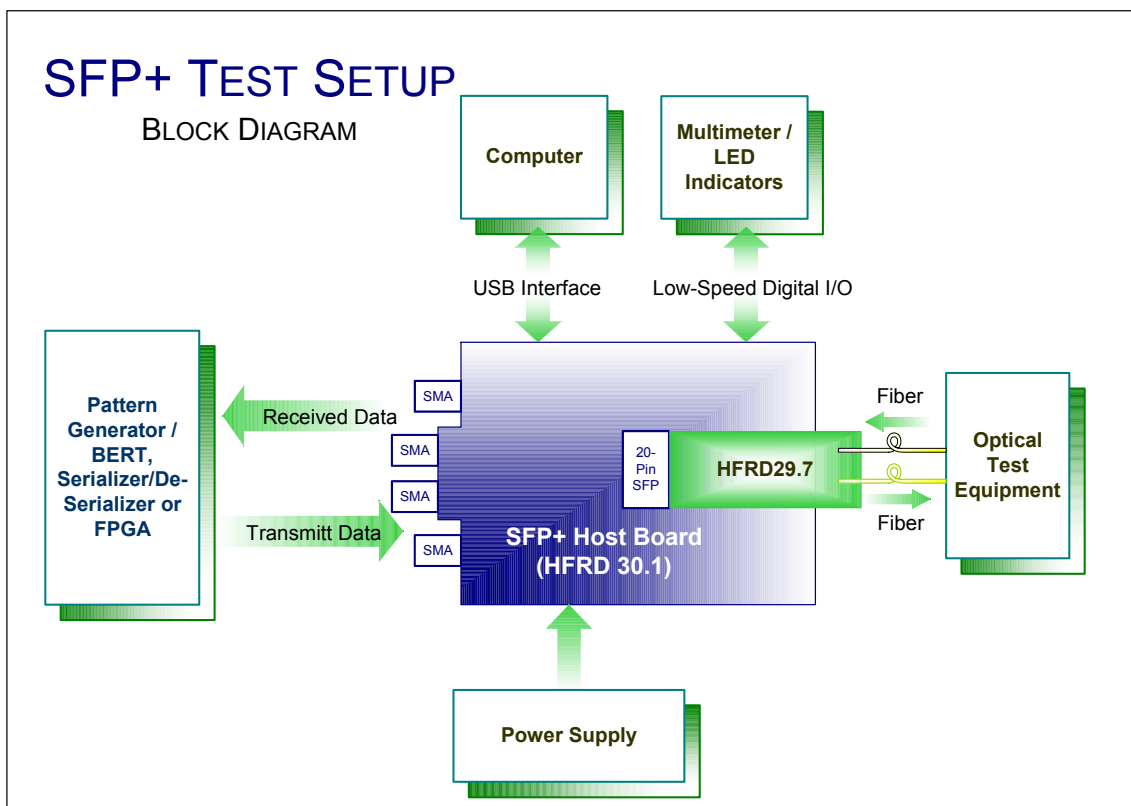

Figure 2. HFRD-29.7 with HFRD-30.1 host PCB.

- 1) Start with the host board. Attach a differential source such as a pattern generator to the Tx data inputs using equal lengths of high-speed SMA coax cable. The output level of the pattern generator should be set to a nominal level of 1V differential.
 - 2) Connect the Rx data SMA outputs on the host PCB to either an oscilloscope or BERT which is triggered by the pattern generator.
 - 3) Connect a computer to the USB port on the host PCB. The GUI software provided with this reference design should be installed in this computer.
 - 4) Connect a power supply to the 3.3V terminal on the host board. Set the power-supply current limit to 250mA. Do not apply power.
 - 5) Insert the HFRD-29.7 into the host board.
 - 6) Carefully insert an LC multimode fiber-optic cable into the TOSA barrel; take care not to strain the TOSA flex. The optical cable should be secured to prevent damage to the TOSA if the fiber is accidentally moved.
 - 7) Connect the other end of the fiber-optic cable to a high-speed oscilloscope through an optical-to-electrical converter or an optical plug-in module. The optical-to-electrical conversion should have a bandwidth sufficiently large for the operating bit rate and should be able to detect 850nm wavelengths.
- Note: The laser supplied with the reference design may be capable of delivering more than 1mW of power. Attenuation may be required if the optical power exceeds the optical-to-electrical device's input power rating.**
- 8) To view the receiver output, attach equal length high-speed SMA coaxial cables to the differential outputs from the host board to the oscilloscope.
 - 9) Connect a multimode fiber with an LC-type ferrule to the ROSA. Follow the same precautions outlined in step 6 above.

10) Connect the other end of the fiber to a high-speed 850nm optical source through an optical attenuator.

11) Apply power to the host board. Current draw should be less than 200mA.

12) The transceiver registers are preset to permit operation without running the GUI. To enable the optical output without running the GUI, connect the Tx disable test point on the host board to ground. The optical transmit eye should be observable on the scope.

13) The receiver output and LOS will also be operational. If an external reference transmitter is used as an optical source to test the receiver, the output electrical eye will be active. The RS0 is pulled high on the host board (wide bandwidth, low gain).

8 SFP+ Evaluation Software

Running the GUI allows the user to access and modify the settings within the MAX3798. The GUI also displays several monitor functions:

- Temperature
- VCC
- VCSEL monitor level
- Bias current
- RSSI level

In the firmware provided with this reference design, all functions except the bias current (mA) are displayed in the GUI in an uncalibrated format.

8.1. Running the GUI

Activate the GUI. The screen shown below should appear.

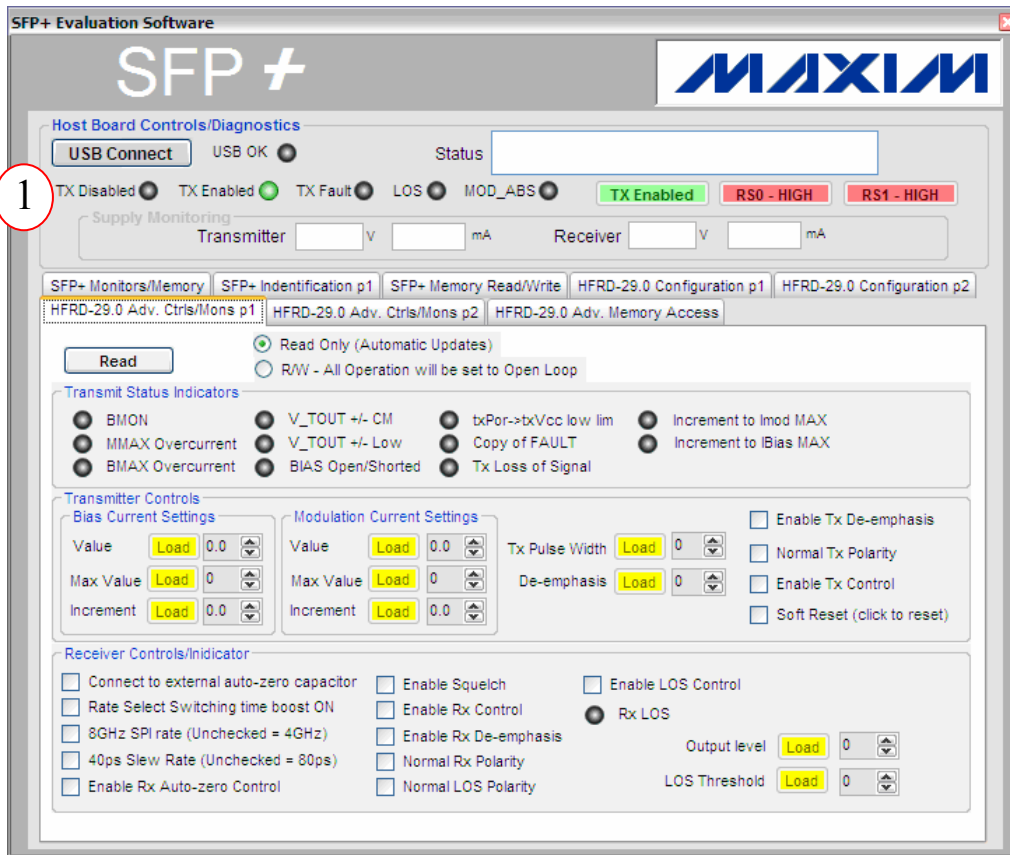

1. USB Connect. Pressing this button initializes the test communication. This button resets the GUI interface and initializes a test sequence to determine if the HFRD-30.1 is connected to the computer. The software then scans the I²C bus to determine if any I²C-addressable modules are connected to the HFRD-30.1 host board.

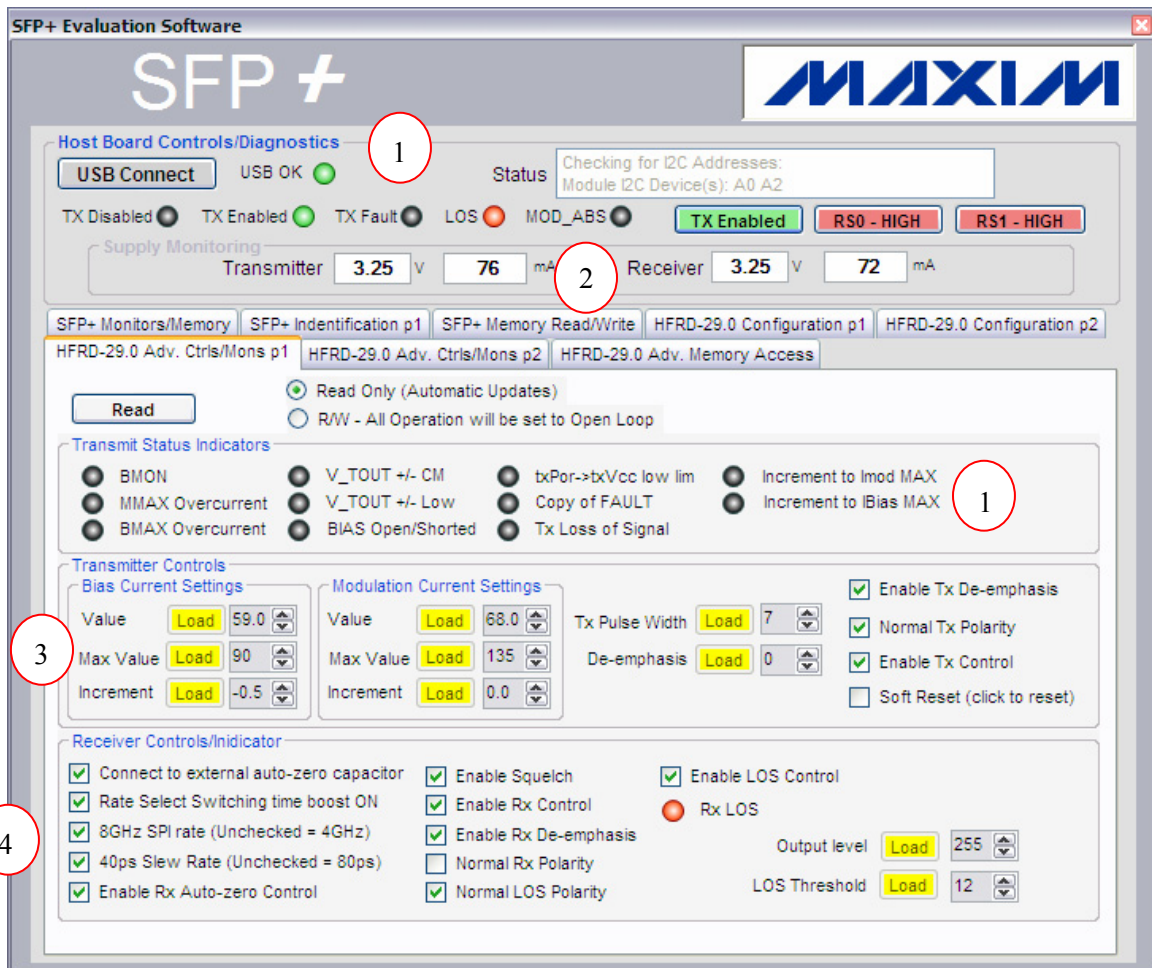

1. Status LEDs and Controls. Pressing **TX Enabled** or **TX Disabled** enables or disables the transmitter. Pressing **RS0** or **RS1** will toggle the output high or low. Transmit status indicators are also displayed.

2. Supply Monitoring. This section displays the voltage and current for the SFP+ module. The transmitter and receiver VCC are connected together inside the SFP+ module. The SFP+ host board splits the current-draw reading, so the total current draw for the module is the sum of the transmit and receiver current.

3. Transmitter Controls. The majority of transmitter control registers are handled here. Toggle settings are provided for bias current and modulation current registers, as well as pulse-width selection and de-emphasis. When the APC loop is in operation, the bias current is automatically controlled and set by the microprocessor.

4. Receiver Controls/Indicator. The receiver control functions are handled in this section. Output level and LOS threshold are adjustable. An Rx LOS indicator replicates the indicator located on the host board. **Note:** To allow the option of selecting the low-bandwidth high-gain setting (8GHz is unchecked), the RS0 test point on the host board must be connected to ground. Otherwise the bandwidth will remain in the high condition.

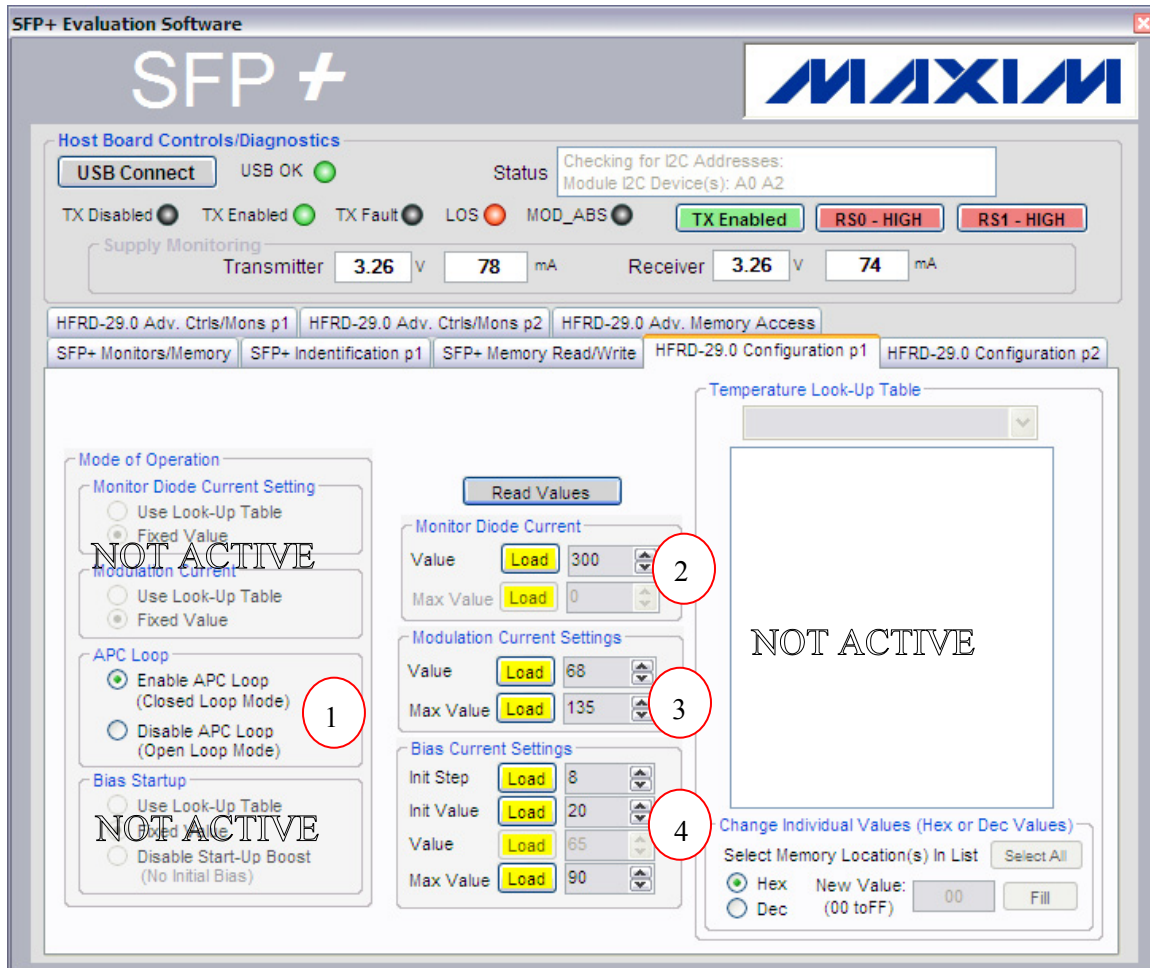

1. APC Loop. The APC loop function is enabled or disabled depending upon the setting selected.

2. Monitor Diode Current. This function selects the level of monitor diode current (arbitrary units) that is maintained by the APC loop. If the APC loop is disabled, then this setting has no effect.

3. Modulation Current Settings. This is a duplicate function also provided in the “Transmitter Controls” section above.

4. Bias Current Settings. These settings control the initial value and initial step size used by the APC algorithm when the TX Enabled is activated. A larger initial starting value and step size reduces the APC loop convergence time. Entering too large an initial value for bias can result in the optical output overshooting during TX Enabled. The Max Value is a duplicate entry, also provided in the “Transmitter Controls” section.

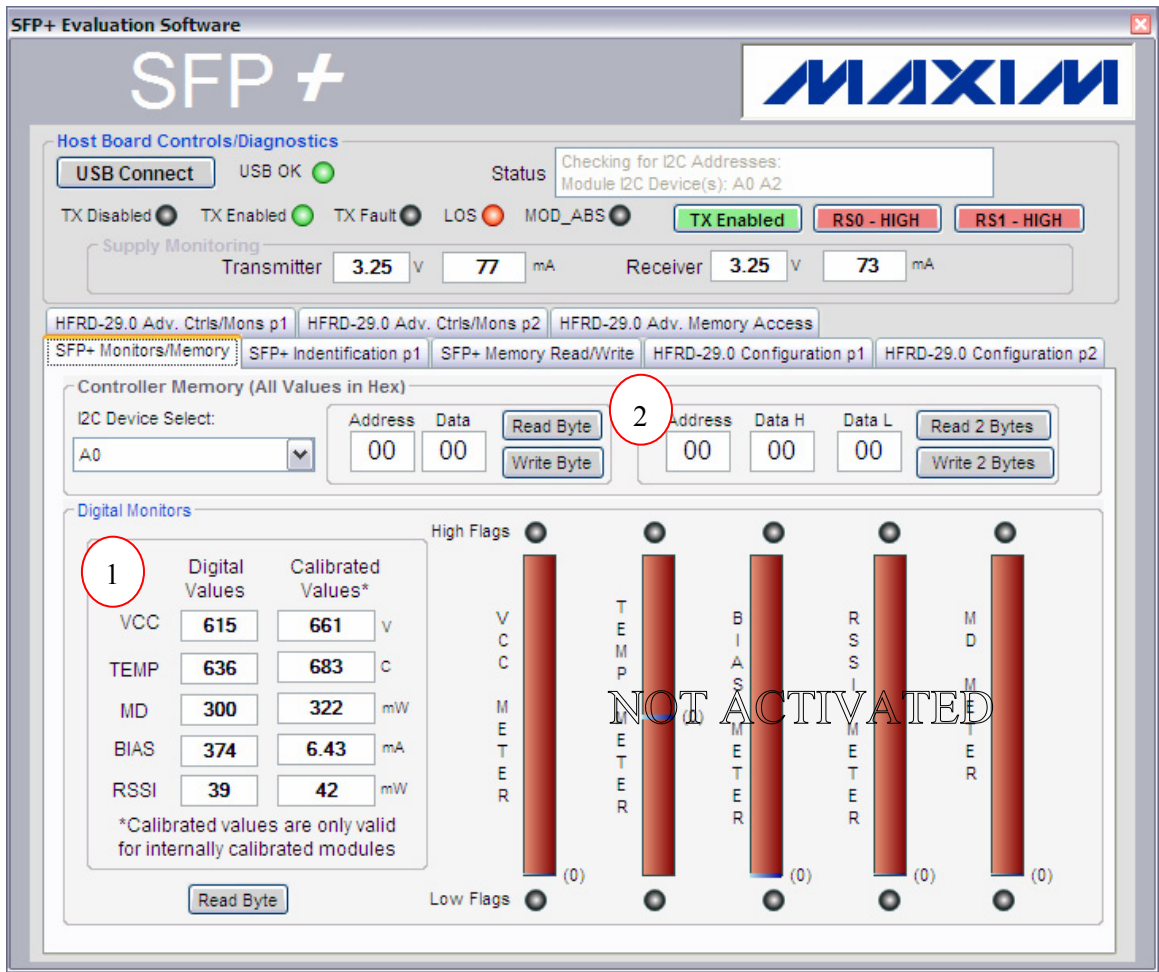

1. Digital Monitors. All values displayed are uncalibrated except for bias current.

2. Controller Memory. This section allows the user to read and write to the controller memory.

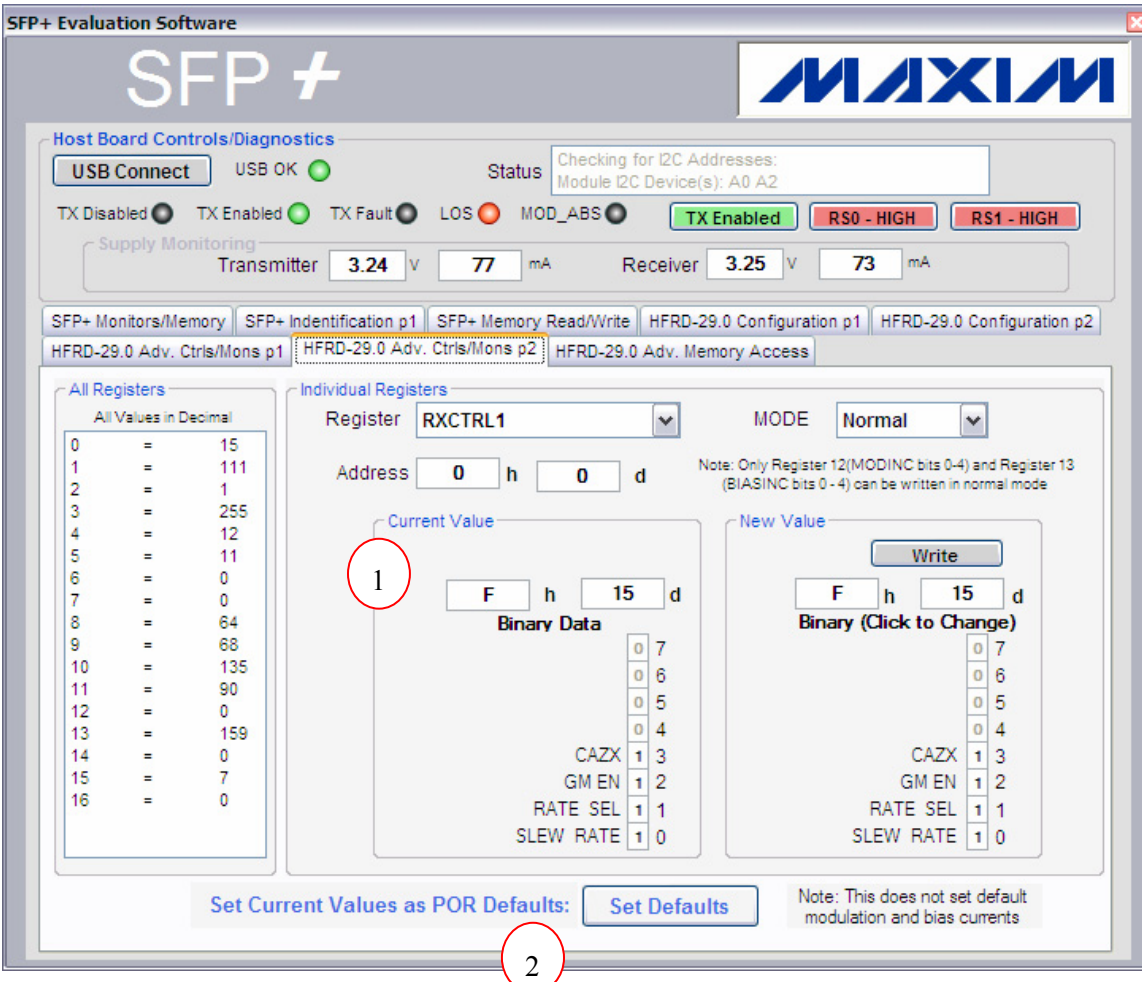

1. Individual Registers. This section provides an alternate way to set specific control bits. Select the desired register from the pulldown, toggle the desired bits in the New Value section, and press **write**. The newly written values should appear in the Current Value section.

2. Set Defaults. Prior to removing power from the module, press the Set Defaults button to save the latest changes to transmitter and receiver settings. Otherwise, upon activation of power the previous default values will be loaded.

9 Signal Definitions

Connector Pin	I/O Type	NAME	Definition
1, 17, 20		VEET	Module transmitter ground (Note 4)
2	LVTTTL OUTPUT	TX_FAULT	Transmitter fault output (Note 1); the transmitter is disabled when TX_FAULT is asserted.
3	LVTTTL INPUT	TX_DISABLE	Transmitter disable input; the transmitter is disabled when TX_DISABLE is asserted.
4	LVTTTL INPUT / OUTPUT	MOD-DEF2	2-wire serial interface, bidirectional data line (Note 1)
5	LVTTTL INPUT	MOD-DEF1	2-Wire serial interface clock line (Note 1)
6	LVTTTL OUTPUT	MOD-DEF0	Pin is pulled low by the SFP+ module to indicate to the host controller that a module is present (Note 1).
7	LVTTTL INPUT	RATE SEL1	Optional bandwidth selection input (not used in HFRD-29.7)
8	LVTTTL OUTPUT	LOS	Receiver loss-of-signal output (Note 1); output is high when receiver input signal is below the set threshold (Note 2).
9	LVTTTL INPUT	RS0	Sets receiver input mode (0 = high gain, low BW; 1= low gain, high BW).
10, 11, 14		VEER	Module receiver ground (Note 4)
12	OUTPUT	RD-	Inverted received data output, AC-coupled inside the SFP+ module
13	OUTPUT	RD+	Noninverted received data output, AC-coupled inside the SFP+ module
15		VCCR	+3.3V receiver power-supply connection; may be internally connected to VCCT inside the SFP+ module (Note: 3).
16		VCCT	+3.3V transmitter power-supply connection; may be internally connected to VCCR inside the SFP+ module (Note: 3).
18	INPUT	TD+	Inverted transmit data input, AC-coupled inside the SFP+ module
19	INPUT	TD-	Noninverted transmit data input, AC-coupled inside the SFP+ module

Note 1: Open collector output. These pins must be pulled high (+2.95V to +3.65V) on the host board through a 4.7k Ω to 10k Ω resistor.

Note 2: LOS function can be inverted, if desired, in the HFRD-29.7.

Note 3: VCCR and VCCT are connected together inside HFRD-29.7.

Note 4: VEER and VEET are connected together inside HFRD-29.7

10 Component List

Reference	Qty	Value	Description
C1 C3 C8 C11-12	5	0.1 μ F	CAPACITOR (0201)
C10 C37	2	0.001 μ F	CAPACITOR (0402)
C13	1	680pF	CAPACITOR (0201)
C15 C19 C31 C36	4	1.0 μ F	CAPACITOR (0402)
C16 C30 C34 C40-42	6	0.01 μ F	CAPACITOR (0201)
C2 C14 C17 C22-23 C25 C27-29 C33 C35 C38	12	0.01 μ F	CAPACITOR (0402)
C4 C20-21	3	680pF	CAPACITOR (0402)
C5-6	2	20pF	CAPACITOR (0201)
C7 C9 C18 C24 C26 C32 C39	7	0.1 μ F	CAPACITOR (0402)
D1	1		DIODE, ROHM RB521CS-30
JU1	1		SOLDER JUMPER (0201)
L1-2 L11	3		BEAD, MURATA BLM15BD601SN1
L12-13	2	47 μ H	INDUCTOR (0603) TAIYO YUDEN LBMF1608T470K
L4 L10	2		BEAD, MURATA BLM15HB121SN1
L5 L8	2		BEAD, MURATA BLM18GG601SN1
L7 L9 L6 L3	4		BEAD, MURATA BLM15HG102SN1
R10	1	4.99K	RESISTOR (0402)
R11-12 R14 R20 R22	5	8.06K	RESISTOR (0402)
R1-3 R7 R15 R17	6	10.0K	RESISTOR (0402)
R16	1	49.9	RESISTOR (0402)
R18	1	4.75K	RESISTOR (0402)
R19	1	511	RESISTOR (0402)
R23 R26	2	DNI	RESISTOR (0402) Note 1
R24-25	2	0	RESISTOR (0402) Note 1
R27-28	2	DNI	RESISTOR (0201) Note 2
R29-30	2	0	RESISTOR (0201) Note 2
R4	1	1.0K	RESISTOR (0402)
R5	1	6.81K	RESISTOR (0402)
R6 R13	2	30.1	RESISTOR (0201)
R8 R21	2	1.0K	RESISTOR (0402)
R9	1	20.0K	RESISTOR (0402)
U1	1		ATMEL ATMEGA88V-10MU MICROCONTROLLER
U2	1		MAX3798
U3	1		TOSA w FLEX
U4	1		ROSA w FLEX
U5	1		PMOS TRANSISTOR FAIRCHILD FDN302P
U6	1		LM20BIM71NOPB, NATIONAL TEMP SENSOR
U7	1		MAX4073TAXK-T IN SC70-5
U8	1		NC7WZ07P6X, BUFFER IC NON-INVERTING

Note 1: For ground reference RSSI operation: R26 = 1k Ω , R23 = 0 Ω , R24-25 = DNI, U7 = DNI. Jumper pin 1 to pin 4 at U7 location.

Note 2: To increase buffer attenuator from 0dB to 4dB, R29 to R30 = 24 Ω , R27 to R28 = 440 Ω .

11 Schematic

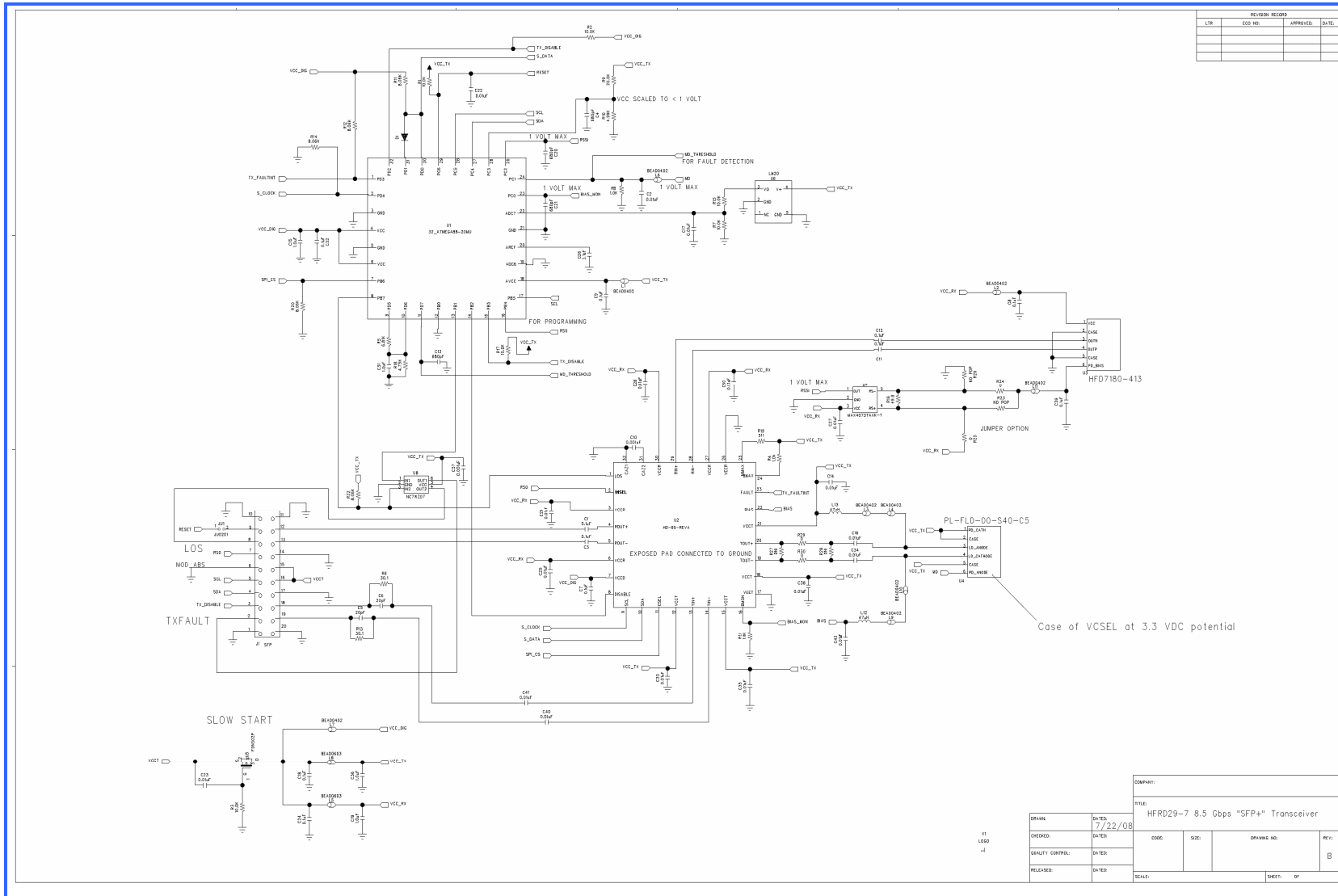

Figure 3. HFRD-29.7 schematic.

12 Board Layout

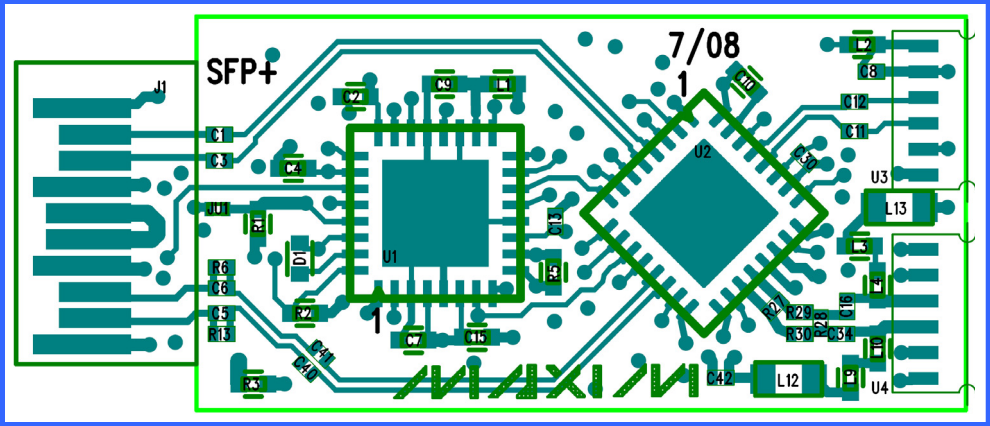

Figure 4. Board layout, component side—Layer 1

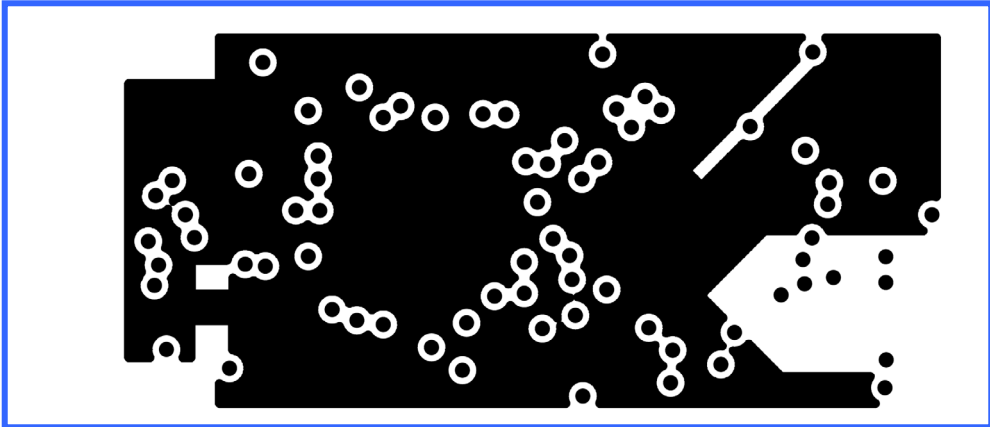

Figure 5. Board layout, ground plane—Layer 2.

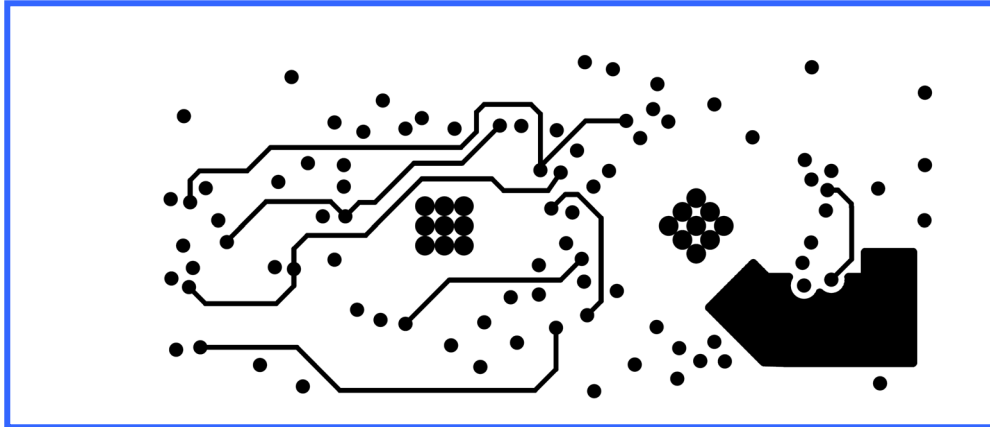

Figure 6. Board layout, miscellaneous routing and VCC—Layer 3.

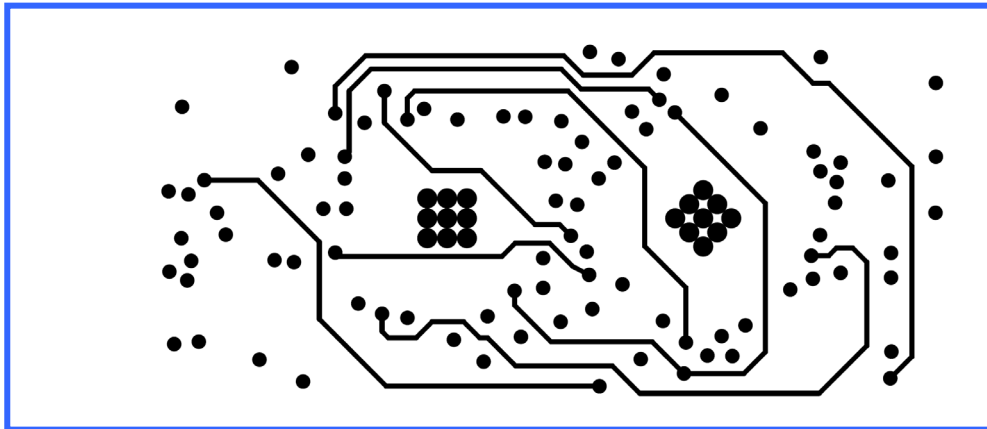

Figure 7. Board layout, miscellaneous routing—Layer 4.

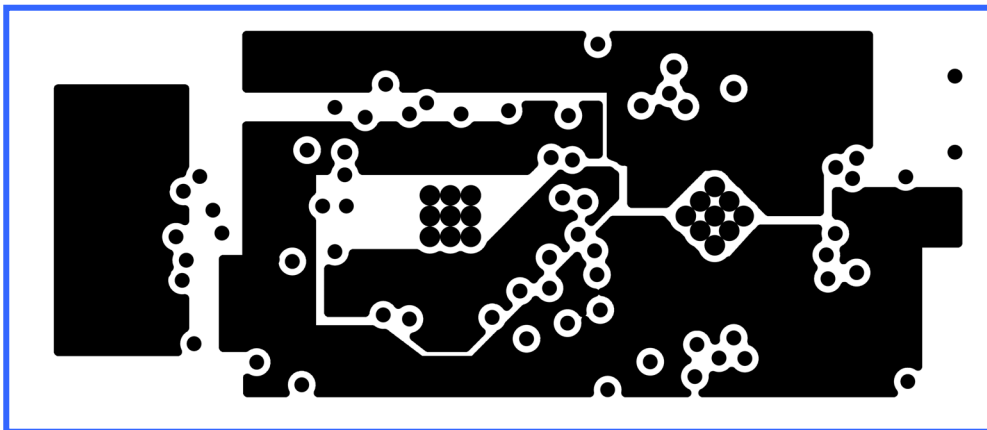

Figure 8. Board layout, VCC plane—Layer 5.

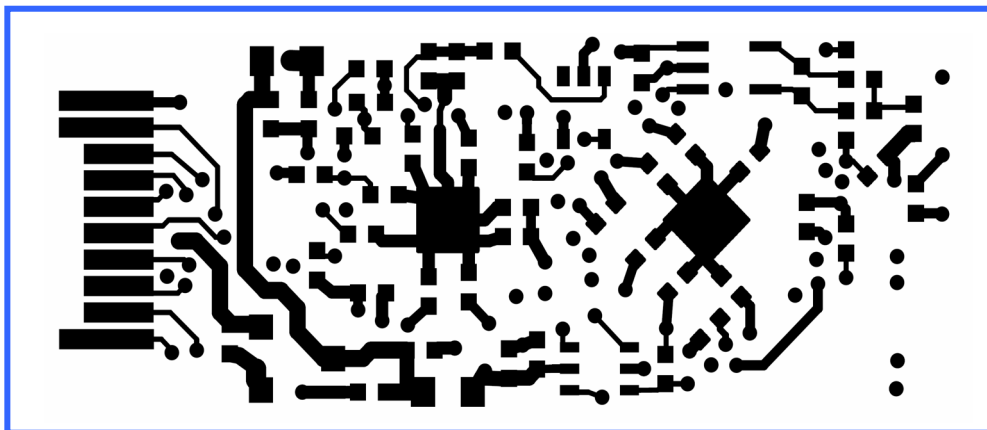

Figure 9. Board layout, solder side—Layer 6.

13 Layer Profile

The HFRD-29.7 includes controlled-impedance transmission lines. The layer profile is shown in Figure 10. The controlled-impedance transmission line connecting the output of the MAX3798 to the TOSA Flex is between layer 1 and layer 3. A dielectric constant of 4.3 is assumed.

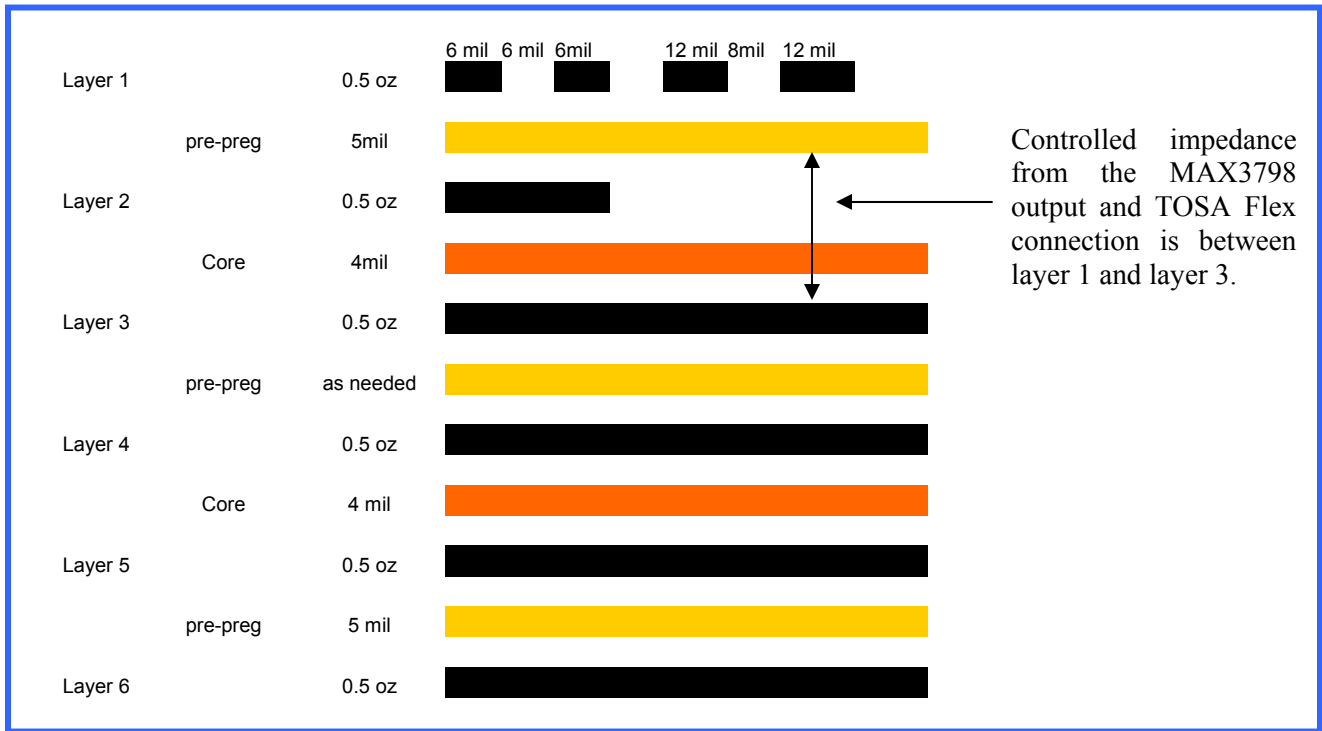

Figure 10. Layer Profile for HFRD-29.7

EMCORE is a registered trademark of EMCORE Corp.

Finisar is a registered trademark of Finisar Corp.

JDSU is a trademark of JDS Uniphase Corporation.