



### FEATURES

- UL 60950 recognised
- Efficiency from 80%
- Wide temperature performance at full 2 Watt load, -40°C to 85°C
- Industry standard pinout
- 1kVDC isolation 'Hi Pot Test'
- 5V, 12V, 15V & 24V input
- 5V, 9V, 12V, & 15V output
- Internal SMD construction
- No external components required
- MTF up to 3.9 million hours
- Pin compatible with CMR, CRR1, NMR & MER1 series
- No electrolytic or tantalum capacitors

### PRODUCT OVERVIEW

The NMG series of DC/DC Converters is particularly suited to isolating and/or converting DC power rails. The galvanic isolation allows the device to be configured to provide an isolated negative rail in systems where only positive rails exist. The wide temperature range guarantees startup from -40°C and full 2 watt output at 85°C.

### SELECTION GUIDE

Order Code	Nominal Input Voltage	Output Voltage	Output Current	Input Current at Rated Load	Load Regulation (Typ)	Load Regulation (Max)	Ripple & Noise (Typ) <sup>1</sup>	Ripple & Noise (Max) <sup>1</sup>	Efficiency (Min.)	Efficiency (Typ.)	Isolation Capacitance	MTTF <sup>2</sup>
	V	V	mA	mA	%	%	mVp-p	mVp-p	%	%	pF	kHrs
NMG0505SC	5	5	400	470	5.7	7.3	28	35	81	83	33	3956
NMG0509SC	5	9	222	455	4.2	5.9	20	25	84	86.5	40	3682
NMG0512SC	5	12	167	450	3.8	5.1	18	25	84	87.5	40	3299
NMG0515SC	5	15	133	450	3.4	4.5	16	25	84	87.5	40	2833
NMG0524SC	5	24	83	465	4.3	6	35	60	82	85	35	2189
NMG1205SC	12	5	400	200	4.2	4.9	22	35	81	83.5	40	2519
NMG1209SC	12	9	222	190	2.6	3.1	16	25	83	87	61	2405
NMG1212SC	12	12	167	190	2.4	2.9	13	25	85	88	74	2235
NMG1215SC	12	15	133	185	2.0	2.4	12	25	85	88	68	2011
NMG1224SC	12	24	83	190	2.6	4	25	40	84	86.5	60	2189
NMG1505SC	15	5	400	160	4.3	6	40	60	80	83	40	3963
NMG1509SC	15	9	222	155	2.9	4.5	25	40	82	86.5	55	3176
NMG1512SC	15	12	167	150	2.4	3.5	25	40	84	87.5	65	2875
NMG1515SC	15	15	133	150	2.3	3.5	25	40	84	88	75	2483
NMG2405SC	24	5	400	100	4.1	6	40	70	80	84	45	3659
NMG2409SC	24	9	222	95	2.6	4	30	50	84	87.5	55	2496
NMG2412SC	24	12	167	95	2.1	3.5	25	50	84	88	75	3824
NMG2415SC	24	15	133	95	2	3.5	30	50	85	88.5	85	3500

When operated with additional external load capacitance the rise time of the input voltage will determine the maximum external capacitance value for guaranteed start up. The slower the rise time of the input voltage the greater the maximum value of the additional external capacitance for reliable start up.

### INPUT CHARACTERISTICS

Parameter	Conditions	Min.	Typ.	Max.	Units
Voltage range	Continuous operation, 5V input types	4.5	5	5.5	V
	Continuous operation, 12V input types	10.8	12	13.2	
	Continuous operation, 15V input types	13.5	15	16.5	
	Continuous operation, 24V input types	21.6	24	26.4	
Reflected ripple current			7.5	15	mA p-p

### ABSOLUTE MAXIMUM RATINGS

Lead temperature 1.5mm from case for 10 seconds	260°C
Input voltage V <sub>IN</sub> , NMG05 types	7V
Input voltage V <sub>IN</sub> , NMG12 types	15V
Input voltage V <sub>IN</sub> , NMG15 types	18V
Input voltage V <sub>IN</sub> , NMG24 types	28V

### OUTPUT CHARACTERISTICS

Parameter	Conditions	Min.	Typ.	Max.	Units
Rated Power	T <sub>A</sub> = -40°C to 85°C			2	W
Voltage Set Point Accuracy	See tolerance envelope				
Line regulation	High V <sub>IN</sub> to low V <sub>IN</sub>		1.05	1.2	%/%



For full details go to [www.murata-ps.com/rohs](http://www.murata-ps.com/rohs)



1. See Ripple & Noise characterisation method.

2. Calculated using MIL-HDBK-217F FN2 with nominal input voltage at full load.

All specifications typical at T<sub>A</sub> = 25°C, nominal input voltage and rated output current unless otherwise specified.

### ISOLATION CHARACTERISTICS

Parameter	Conditions	Min.	Typ.	Max.	Units
Isolation test voltage	Flash tested for 1 second	1000			VDC
Resistance	Viso= 1000VDC	10			GΩ

### GENERAL CHARACTERISTICS

Parameter	Conditions	Min.	Typ.	Max.	Units
Switching frequency	24V output types		70		kHz
	All other types		60		

### TEMPERATURE CHARACTERISTICS

Parameter	Conditions	Min.	Typ.	Max.	Units
Specification	All output types	-40		85	°C
Storage		-50		125	
Case Temperature above ambient	5V input types and 5V output types All other types			30 25	
Cooling	Free air convection				

### EFFICIENCY VS LOAD

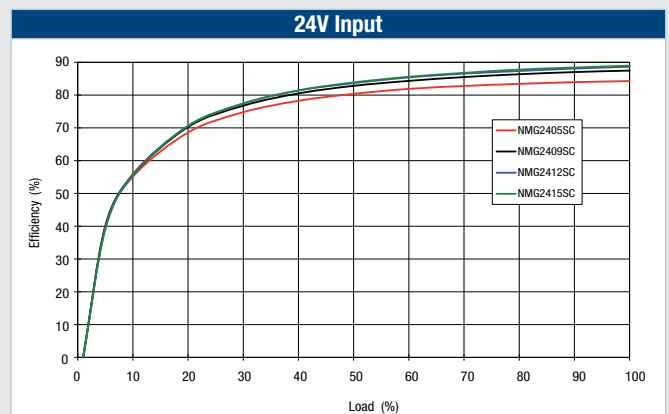
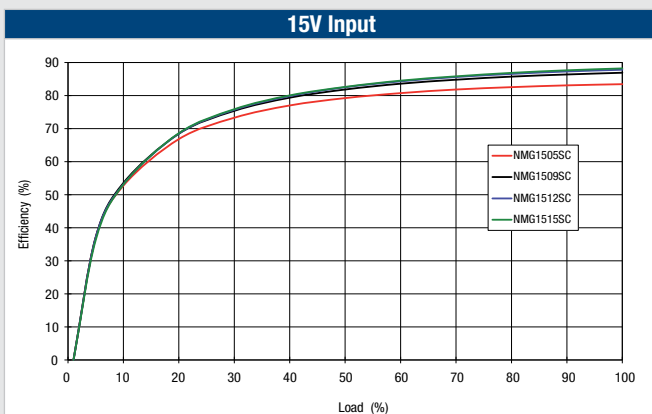
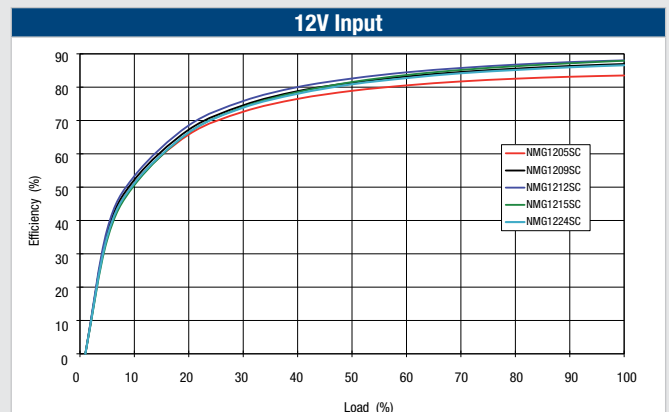
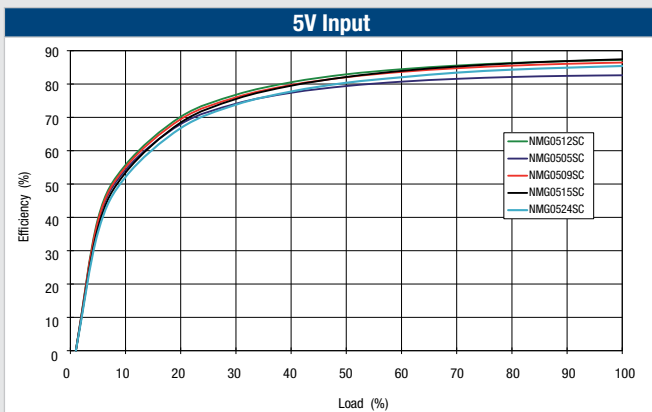

**TEMPERATURE DERATING GRAPH**

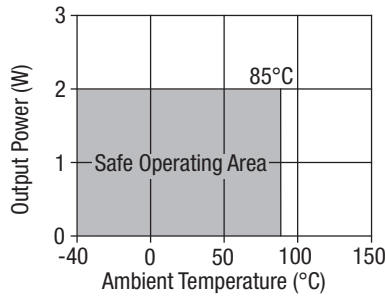

**TECHNICAL NOTES**

**ISOLATION VOLTAGE**

'Hi Pot Test', 'Flash Tested', 'Withstand Voltage', 'Proof Voltage', 'Dielectric Withstand Voltage' & 'Isolation Test Voltage' are all terms that relate to the same thing, a test voltage, applied for a specified time, across a component designed to provide electrical isolation, to verify the integrity of that isolation.

Murata Power Solutions NMG series of DC/DC converters are all 100% production tested at their stated isolation voltage. This is 1kVDC for 1 minute.

A question commonly asked is, "What is the continuous voltage that can be applied across the part in normal operation?"

The NMG series has been recognized by Underwriters Laboratory for functional insulation. Both input and output should normally be maintained within SELV limits i.e. less than 42.4V peak, or 60VDC. The isolation test voltage represents a measure of immunity to transient voltages and the part should never be used as an element of a safety isolation system. The part could be expected to function correctly with several hundred volts offset applied continuously across the isolation barrier; but then the circuitry on both sides of the barrier must be regarded as operating at an unsafe voltage and further isolation/insulation systems must form a barrier between these circuits and any user-accessible circuitry according to safety standard requirements.

**REPEATED HIGH-VOLTAGE ISOLATION TESTING**

It is well known that repeated high-voltage isolation testing of a barrier component can actually degrade isolation capability, to a lesser or greater degree depending on materials, construction and environment. The NMG series has toroidal isolation transformers, with no additional insulation between primary and secondary windings of enameled wire. While parts can be expected to withstand several times the stated test voltage, the isolation capability does depend on the wire insulation. Any material, including this enamel (typically polyurethane) is susceptible to eventual chemical degradation when subject to very high applied voltages thus implying that the number of tests should be strictly limited. We therefore strongly advise against repeated high voltage isolation testing, but if it is absolutely required, that the voltage be reduced by 20% from specified test voltage.

This consideration equally applies to agency recognized parts rated for better than functional isolation where the wire enamel insulation is always supplemented by a further insulation system of physical spacing or barriers.

**SAFETY APPROVAL**

The NMG series has been recognised by Underwriters Laboratory (UL) to UL 60950 for functional insulation in a maximum ambient temperature of 85°C and/or case temperature limit of 130°C. Case temperature measured on the face opposite the pins. File number E151252 applies.

The NMG Series of converters are not internally fused so to meet the requirements of UL 60950 an input line fuse should always be used. An anti-surge 2A should be used for NMG05xxSC models, and an anti-surge 0.75A should be used for NMG12xxSC models. All fuses should be UL approved and rated to at least the maximum allowable DC input voltage.

**RoHS COMPLIANCE INFORMATION**



This series is compatible with RoHS soldering systems with a peak wave solder temperature of 260°C for 10 seconds. The pin termination finish is Tin Plate, Hot Dipped over Matte Tin with Nickel Preplate. This series are backward compatible with Sn/Pb soldering systems. For further information, please visit [www.murata-ps.com/rohs](http://www.murata-ps.com/rohs)

**APPLICATION NOTES**

**Minimum load**

The minimum load to meet datasheet specification is 10% of the full rated load across the specified input voltage range. Lower than 10% minimum loading will result in an increase in output voltage, which may rise to typically double the specified output voltage if the output load falls to less than 5%.

**Capacitive loading and start up**

Typical start up times for this series, with a typical input voltage rise time of 2.2µs and output capacitance of 10µF, are shown in the table below. The product series will start into a capacitance of 47µF with an increased start time, however, the maximum recommended output capacitance is 10µF.

	Start-up time µs		Start-up time µs
NMG0505SC	444	NMG1505SC	100
NMG0509SC	1120	NMG1509SC	170
NMG0512SC	1930	NMG1512SC	300
NMG0515SC	3470	NMG1515SC	450
NMG1205SC	409	NMG2405SC	80
NMG1209SC	1320	NMG2409SC	130
NMG1212SC	1320	NMG2412SC	220
NMG1215SC	2270	NMG2415SC	330
NMG0524SC	2200		
NMG1224SC	1400		

Typical Start-Up Wave Form

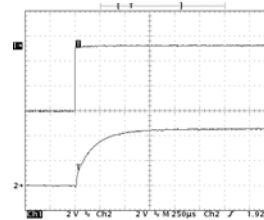

**Ripple & Noise Characterisation Method**

All measurement to be taken with the following components connected to the UUT as detailed below. 50 Ohm coax cable, solder connections one end, BNC plug at the other end.

C1	1µF X7R multilayer ceramic capacitor rated at minimum 3 x the output voltage of the UUT
C2	10µF tantalum capacitor rated at minimum 1.5 x the output voltage of the UUT with ESR of less than 100 milliohms at 100 kHz e.g. AVX TPS series.
C3	100nF multilayer ceramic capacitor, general purpose
R1	450 Ohm resistor, carbon film, ±1%
R2	50 Ohm BNC termination
T1	3T of the coax cable through a ferrite toroid eg Ferroxcube TN32/19/13-3E25
RLOAD	Resistive load at the UUT maximum rating. Connections via twisted wires.

Measured values are multiplied by 10 to obtain the specified values.

**Differential Mode Noise Test Schematic**

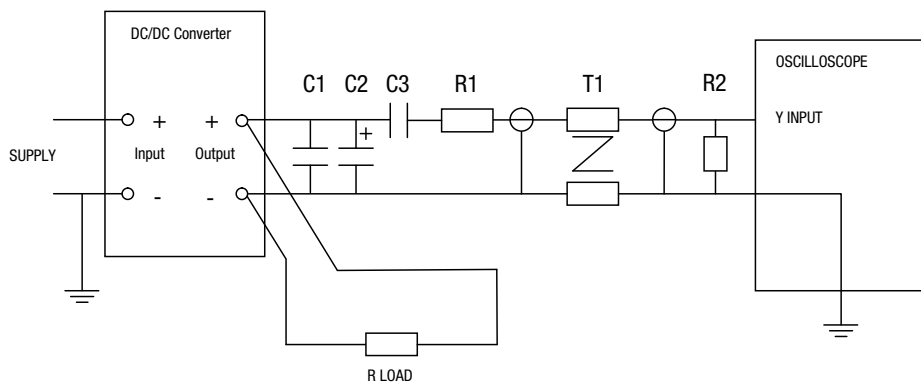

**APPLICATION NOTES (continued)**

**Output Ripple Reduction**

By using the values of inductance and capacitance stated, the output ripple at the rated load is lowered to 5mV p-p max.

**Component selection**

**Capacitor:** It is required that the ESR (Equivalent Series Resistance) should be as low as possible, ceramic types are recommended.

The voltage rating should be at least twice (except for 15V output), the rated output voltage of the DC/DC converter.

**Inductor:** The rated current of the inductor should not be less than that of the output of the DC/DC converter. At the rated current, the DC resistance of the inductor should be such that the voltage drop across the inductor is <2% of the rated voltage of the DC/DC converter. The SRF (Self Resonant Frequency) should be >20MHz.

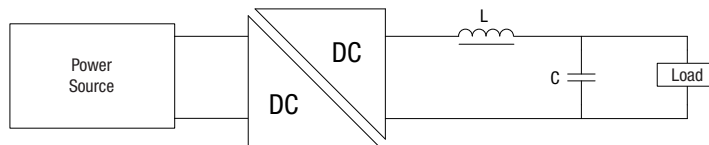

	Inductor			Capacitor
	L, $\mu$ H	SMD	Through Hole	C, $\mu$ F
NMG0505SC	4.7	82472C	11R472C	10
NMG0509SC	10	82103C	11R103C	4.7
NMG0512SC	22	82223C	11R223C	2.2
NMG0515SC	47	82473C	11R473C	1
NMG0524SC	47	82473C	11R473C	1
NMG1205SC	4.7	82472C	11R472C	10
NMG1209SC	10	82103C	11R103C	4.7
NMG1212SC	22	82223C	11R223C	2.2
NMG1215SC	47	82473C	11R473C	1
NMG1224SC	47	82473C	11R473C	1
NMG1505SC	4.7	82472C	11R472C	10
NMG1509SC	10	82103C	11R103C	4.7
NMG1512SC	22	82223C	11R223C	2.2
NMG1515SC	47	82473C	11R473C	1
NMG2405SC	4.7	82472C	11R472C	10
NMG2409SC	10	82103C	11R103C	4.7
NMG2412SC	22	82223C	11R223C	2.2
NMG2415SC	47	82473C	11R473C	1

**TOLERANCE ENVELOPES**

The voltage tolerance envelopes show typical load regulation characteristics for this product series. The tolerance envelope is the maximum output voltage variation due to changes in output loading and set point accuracy.

**1224, 1515, 2412, 2415**

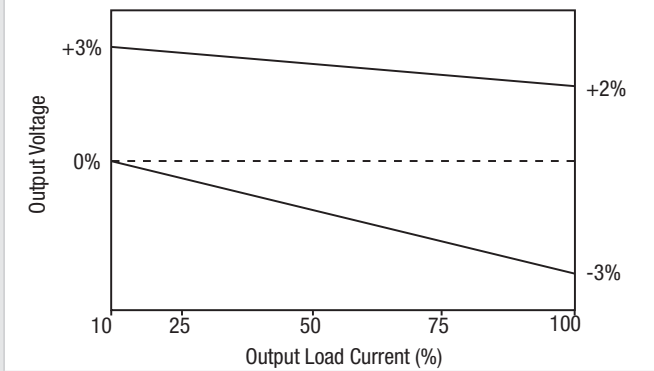

**2405**

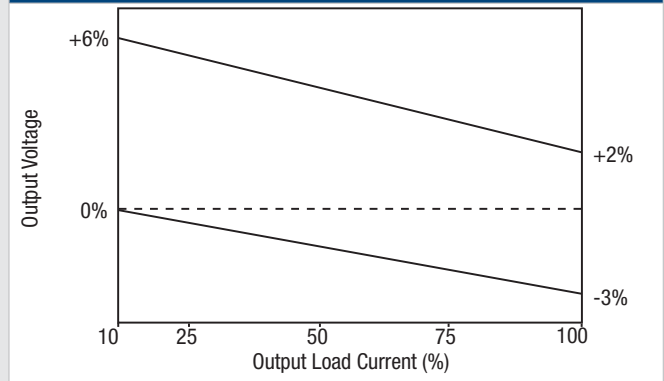

**05XX, 1205, 1209, 1212, 1215, 1505, 1509, 1512, 2409**

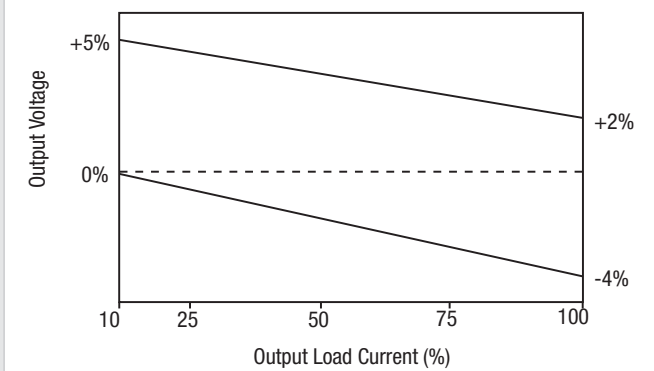

**PACKAGE SPECIFICATIONS**

**MECHANICAL DIMENSIONS**

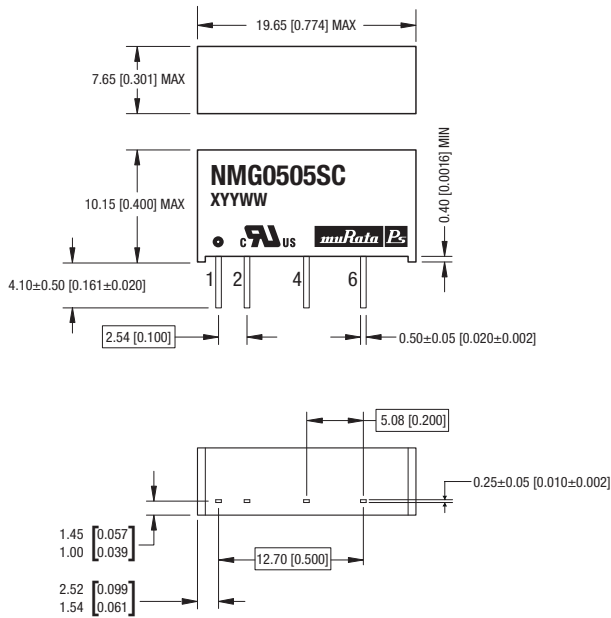

Unless otherwise stated all dimensions in mm (inches)  
 Controlling dimension is mm.  
 All pins on a 2.54mm (0.100") pitch and within 0.25mm (0.010") of true position. Weight: 2.8g

**PIN CONNECTIONS - 4 PIN SIP**

Pin	Function
1	+VIN
2	-VIN
4	-VOUT
6	+VOUT

**TUBE OUTLINE DIMENSIONS**

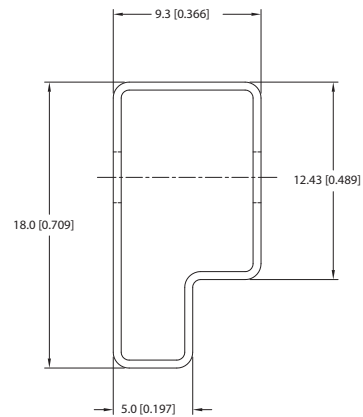

Unless otherwise specified all dimensions in mm [inches] ±0.55mm [0.022].  
 Tube Length : 520mm [20.472] ±2.0 [0.079]. Tube Quantity : 25

**RECOMMENDED FOOTPRINT DETAILS**

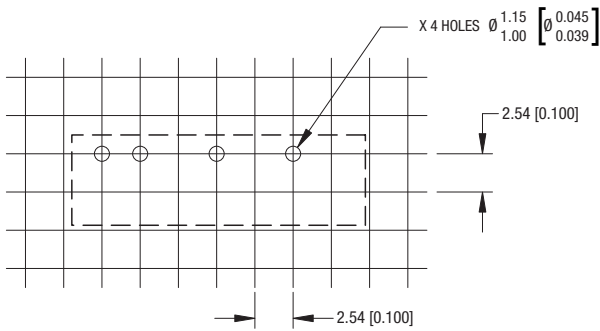

Murata Power Solutions, Inc.  
 11 Cabot Boulevard, Mansfield, MA 02048-1151 U.S.A.  
 ISO 9001 and 14001 REGISTERED



This product is subject to the following **operating requirements** and the **Life and Safety Critical Application Sales Policy**:  
 Refer to: <http://www.murata-ps.com/requirements/>

Murata Power Solutions, Inc. makes no representation that the use of its products in the circuits described herein, or the use of other technical information contained herein, will not infringe upon existing or future patent rights. The descriptions contained herein do not imply the granting of licenses to make, use, or sell equipment constructed in accordance therewith. Specifications are subject to change without notice. © 2017 Murata Power Solutions, Inc.