

SM24CANB Series 500W TVS Diode Array

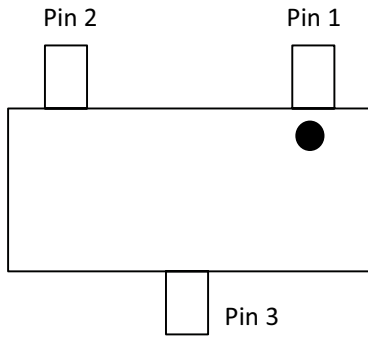

Pinout and Functional Block Diagram



Functional Block Diagram

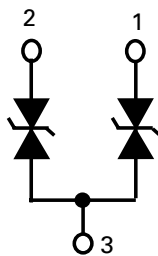

Additional Information



Life Support Note:
Not Intended for Use in Life Support or Life Saving Applications
The products shown herein are not designed for use in life sustaining or life saving applications unless otherwise expressly indicated.

Description

The SM24CANB TVS Diode Array is designed to protect automotive Controller Area Network (CAN) lines from damage due to electrostatic discharge (ESD), electrical fast transient (EFT), and other overvoltage transients.

The SM24CANB Series can absorb repetitive ESD strikes above the maximum level specified in the IEC 61000-4-2 international standard without performance degradation and safely dissipate 10A of 8/20µs surge current (IEC 61000-4-5 2nd Edition) with very low clamping voltages.

Features

- ESD, IEC 61000-4-2, $\pm 30\text{kV}$ contact, $\pm 30\text{kV}$ air (tp=8/20µs)
- EFT, IEC 61000-4-4, 50A (5/50ns)
- RoHS compliant and Lead-free
- Lightning, IEC 61000-4-5 2nd edition, 10A
- Low clamping voltage
- Low leakage current
- AEC-Q101 qualified
- Moisture Sensitivity Level (MSL-1)

Applications

- CAN Bus Protection
- Automotive Networks
- On-Board Diagnostics
- Sensors, Actuators
- EnergyBus
- Industrial Control Networks
- Device Net
- Safety BUS
- CAN open

Application Example

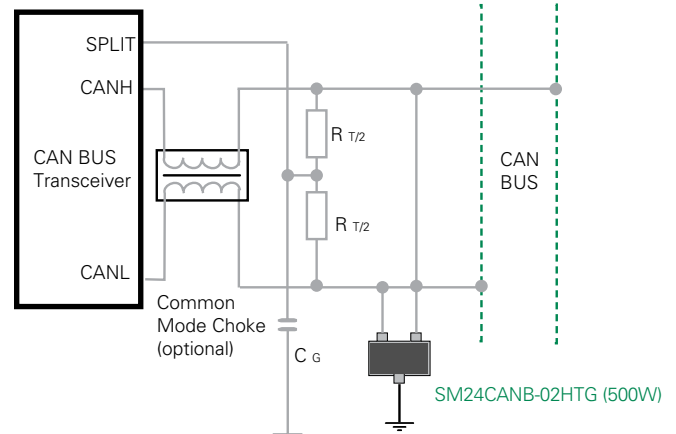

Absolute Maximum Ratings

Symbol	Parameter	Value	Units
P_{PK}	Peak Pulse Power ($t_p=8/20\mu s$)	500	W
I_{PP}	Peak Pulse Current ($t_p=8/20\mu s$)	10.0	A
T_{OP}	Operating Temperature	-40 to 125	°C
T_{STOR}	Storage Temperature	-55 to 150	°C

Notes:

CAUTION: Stresses above those listed in "Absolute Maximum Ratings" may cause permanent damage to the component. This is a stress only rating and operation of the component at these or any other conditions above those indicated in the operational sections of this specification is not implied.

Electrical Characteristics ($T_{OP}=25^\circ C$)

Parameter	Symbol	Test Conditions	Min	Typ	Max	Units
Reverse Standoff Voltage	V_{RWM}	$I_R \leq 1\mu A$, Pin 1 or Pin 2 to Pin 3			24.0	V
Reverse Breakdown Voltage	V_{BR}	$I_T=1mA$, Pin 1 or Pin 2 to Pin 3	26.7			V
Leakage Current	I_{LEAK}	$V_R=24V$, Pin 1 or Pin 2 to Pin 3			0.1	μA
Clamp Voltage ¹	V_C	$I_{PP}=1A$, $t_p=8/20\mu s$, Pin 1 or Pin 2 to Pin 3			34.0	V
		$I_{PP}=8A$, $t_p=8/20\mu s$, Pin 1 or Pin 2 to Pin 3			46.0	V
		$I_{PP}=10A$, $t_p=8/20\mu s$, Pin 1 or Pin 2 to Pin 3			50	V
Dynamic Resistance ²	R_{DYN}	TLP, $t_p=100ns$, Pin 1 or Pin 2 to Pin 3		0.6		Ω
ESD Withstand Voltage ¹	V_{ESD}	IEC 61000-4-2 (Contact Discharge)	± 30			kV
		IEC 61000-4-2 (Air Discharge)	± 30			kV
Diode Capacitance ¹	$C_{I/O-GND}$	Reverse Bias=0V, $f=1MHz$; Pin 1 or Pin 2 to Pin 3		30		pF

Note:

¹ Parameter is guaranteed by design and/or device characterization.

² Transmission Line Pulse (TLP) test setting : Std.TDR(50 Ω), $t_p=100ns$, $t_r=0.2ns$ ITLP and VTLP averaging window: star $t_1=70ns$ to end $t_2=80ns$

Pulse Waveform

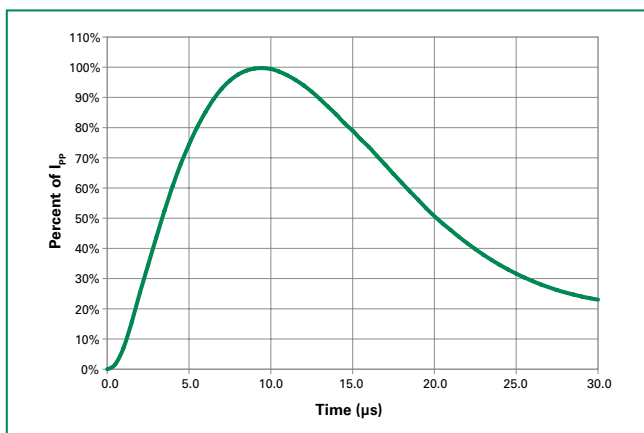

Capacitance vs. Reverse Bias (Pin1 or Pin2 to Pin3)

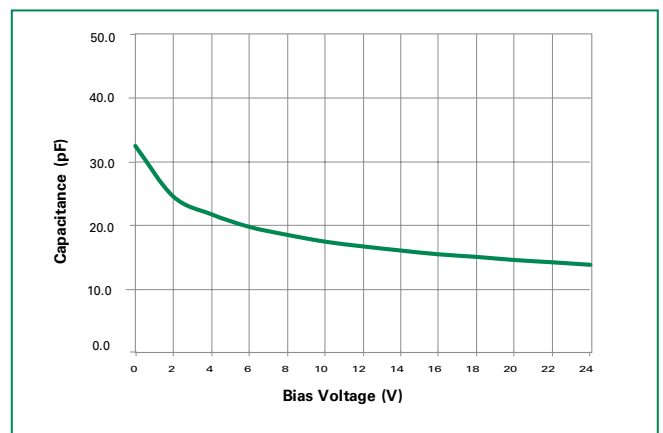

Clamping Voltage vs. Peak Pulse Current (Pin1 or Pin2 to Pin3)

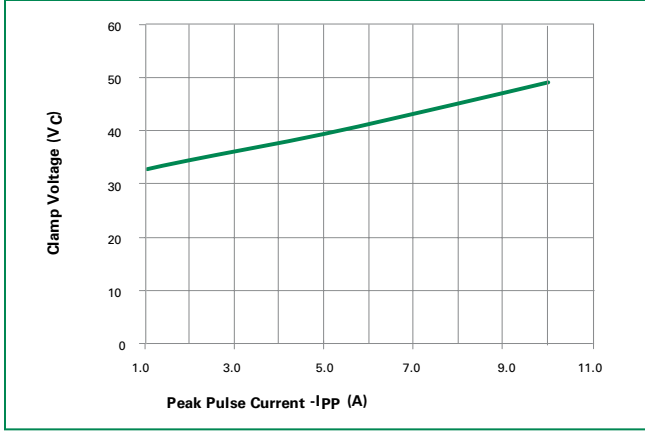

Transmission Line Pulsing (TLP) Plot (Pin1 or Pin2 to Pin3)

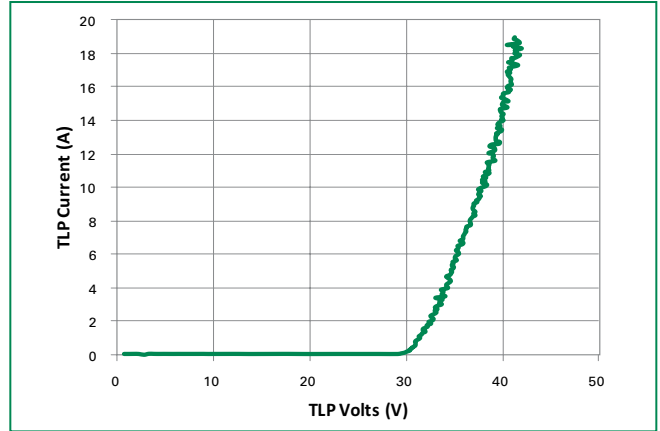

Soldering Parameters

Reflow Condition		Pb – Free assembly
Pre Heat	- Temperature Min ($T_{s(min)}$)	150°C
	- Temperature Max ($T_{s(max)}$)	200°C
	- Time (min to max) (t_s)	60 – 180 secs
Average ramp up rate (Liquidus) Temp (T_L) to peak		3°C/second max
$T_{s(max)}$ to T_L - Ramp-up Rate		3°C/second max
Reflow	- Temperature (T_L) (Liquidus)	217°C
	- Temperature (t_L)	60 – 150 seconds
Peak Temperature (T_p)		260 ^{+0/-5} °C
Time within 5°C of actual peak Temperature (t_p)		20 – 40 seconds
Ramp-down Rate		6°C/second max
Time 25°C to peak Temperature (T_p)		8 minutes Max.
Do not exceed		260°C

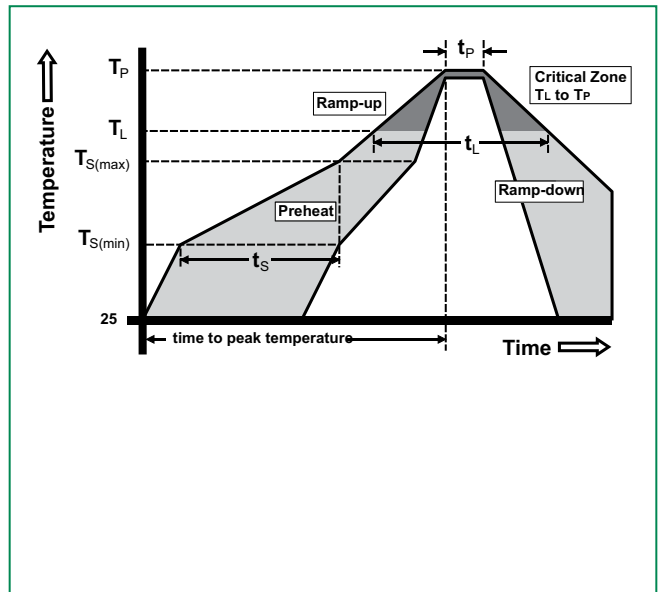

Part Marking System

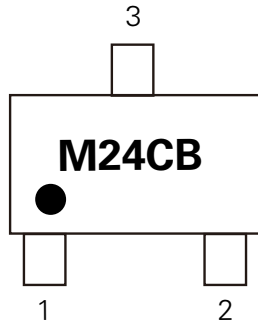

Part Numbering System

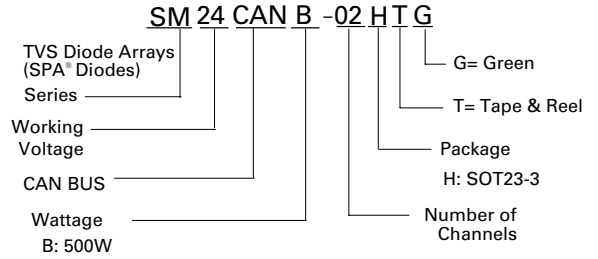

Part Number	Package	Marking	Min. Order Qty.	Packaging Option	P/P0	Packaging Specification
SM24CANB-02HTG	SOT23-3	M24CB	3000	Tape & Reel – 8mm tape/7" reel	4mm/4mm	EIA RS-481

Package Dimensions – SOT23-3

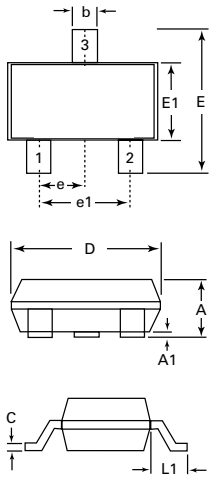

Recommended Pad Layout

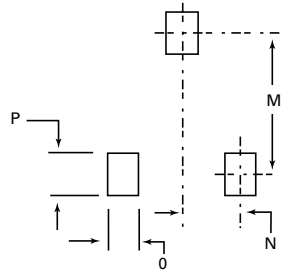

Package	SOT23-3			
Pins	3			
JEDEC	TO-236			
	Millimeters		Inches	
	Min	Max	Min	Max
A	0.89	1.12	0.035	0.044
A1	0.01	0.10	0.0004	0.004
b	0.30	0.50	0.012	0.020
c	0.08	0.2	0.003	0.008
D	2.80	3.04	0.110	0.120
E	2.10	2.64	0.083	0.104
E1	1.20	1.40	0.047	0.055
e	0.95 BSC		0.038 BSC	
e1	1.90 BSC		0.075 BSC	
L1	0.54 REF		0.021 REF	
M		2.29		0.090
N		0.95		0.038
O		0.78		0.030TYP
P		0.78		0.030TYP

Embossed Carrier Tape & Reel Specification – SOT23-3

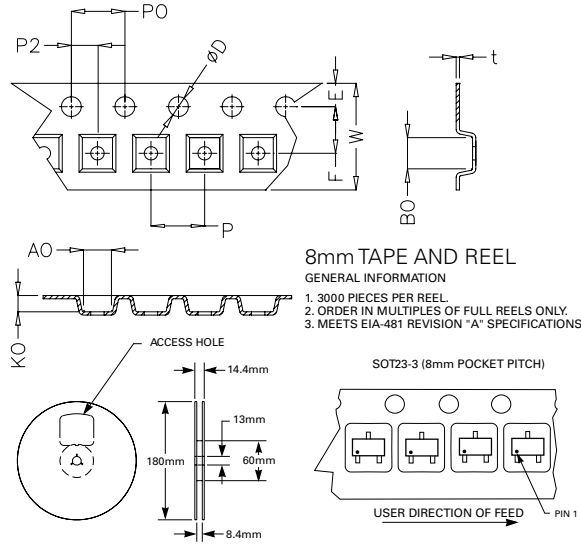

Symbol	Millimetres		Inches	
	Min	Max	Min	Max
E	1.65	1.85	0.065	0.073
F	3.40	3.60	0.134	0.142
P2	1.90	2.10	0.075	0.083
D	1.40	1.60	0.055	0.063
P0	3.90	4.10	0.154	0.161
W	7.70	8.30	0.303	0.327
P	3.90	4.10	0.154	0.161
A0	3.05	3.25	0.120	0.128
B0	2.67	2.87	0.105	0.113
K0	1.12	1.32	0.044	0.052
t	0.22	0.24	0.009	0.009

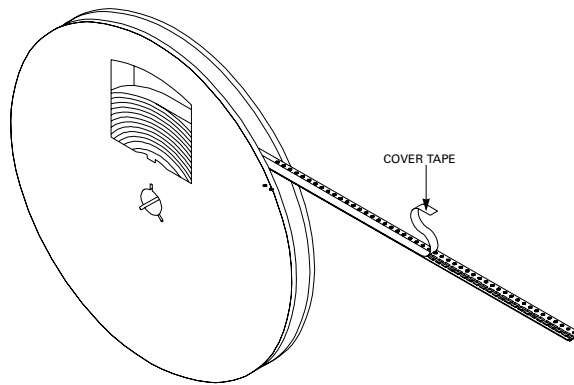

Disclaimer Notice - Information furnished is believed to be accurate and reliable. However, users should independently evaluate the suitability of and test each product selected for their own applications. Littelfuse products are not designed for, and may not be used in, all applications. Read complete Disclaimer Notice at www.littelfuse.com/disclaimer-electronics.