

ON Semiconductor

Is Now

onsemi™

To learn more about onsemi™, please visit our website at
www.onsemi.com

onsemi and **onsemi** and other names, marks, and brands are registered and/or common law trademarks of Semiconductor Components Industries, LLC dba "**onsemi**" or its affiliates and/or subsidiaries in the United States and/or other countries. **onsemi** owns the rights to a number of patents, trademarks, copyrights, trade secrets, and other intellectual property. A listing of **onsemi** product/patent coverage may be accessed at www.onsemi.com/site/pdf/Patent-Marking.pdf. **onsemi** reserves the right to make changes at any time to any products or information herein, without notice. The information herein is provided "as-is" and **onsemi** makes no warranty, representation or guarantee regarding the accuracy of the information, product features, availability, functionality, or suitability of its products for any particular purpose, nor does **onsemi** assume any liability arising out of the application or use of any product or circuit, and specifically disclaims any and all liability, including without limitation special, consequential or incidental damages. Buyer is responsible for its products and applications using **onsemi** products, including compliance with all laws, regulations and safety requirements or standards, regardless of any support or applications information provided by **onsemi**. "Typical" parameters which may be provided in **onsemi** data sheets and/or specifications can and do vary in different applications and actual performance may vary over time. All operating parameters, including "Typicals" must be validated for each customer application by customer's technical experts. **onsemi** does not convey any license under any of its intellectual property rights nor the rights of others. **onsemi** products are not designed, intended, or authorized for use as a critical component in life support systems or any FDA Class 3 medical devices or medical devices with a same or similar classification in a foreign jurisdiction or any devices intended for implantation in the human body. Should Buyer purchase or use **onsemi** products for any such unintended or unauthorized application, Buyer shall indemnify and hold **onsemi** and its officers, employees, subsidiaries, affiliates, and distributors harmless against all claims, costs, damages, and expenses, and reasonable attorney fees arising out of, directly or indirectly, any claim of personal injury or death associated with such unintended or unauthorized use, even if such claim alleges that **onsemi** was negligent regarding the design or manufacture of the part. **onsemi** is an Equal Opportunity/Affirmative Action Employer. This literature is subject to all applicable copyright laws and is not for resale in any manner. Other names and brands may be claimed as the property of others.



Is Now Part of



ON Semiconductor®

To learn more about ON Semiconductor, please visit our website at
www.onsemi.com

Please note: As part of the Fairchild Semiconductor integration, some of the Fairchild orderable part numbers will need to change in order to meet ON Semiconductor's system requirements. Since the ON Semiconductor product management systems do not have the ability to manage part nomenclature that utilizes an underscore (_), the underscore (_) in the Fairchild part numbers will be changed to a dash (-). This document may contain device numbers with an underscore (_). Please check the ON Semiconductor website to verify the updated device numbers. The most current and up-to-date ordering information can be found at www.onsemi.com. Please email any questions regarding the system integration to Fairchild_questions@onsemi.com.

ON Semiconductor and the ON Semiconductor logo are trademarks of Semiconductor Components Industries, LLC dba ON Semiconductor or its subsidiaries in the United States and/or other countries. ON Semiconductor owns the rights to a number of patents, trademarks, copyrights, trade secrets, and other intellectual property. A listing of ON Semiconductor's product/patent coverage may be accessed at www.onsemi.com/site/pdf/Patent-Marking.pdf. ON Semiconductor reserves the right to make changes without further notice to any products herein. ON Semiconductor makes no warranty, representation or guarantee regarding the suitability of its products for any particular purpose, nor does ON Semiconductor assume any liability arising out of the application or use of any product or circuit, and specifically disclaims any and all liability, including without limitation special, consequential or incidental damages. Buyer is responsible for its products and applications using ON Semiconductor products, including compliance with all laws, regulations and safety requirements or standards, regardless of any support or applications information provided by ON Semiconductor. "Typical" parameters which may be provided in ON Semiconductor data sheets and/or specifications can and do vary in different applications and actual performance may vary over time. All operating parameters, including "Typicals" must be validated for each customer application by customer's technical experts. ON Semiconductor does not convey any license under its patent rights nor the rights of others. ON Semiconductor products are not designed, intended, or authorized for use as a critical component in life support systems or any FDA Class 3 medical devices or medical devices with a same or similar classification in a foreign jurisdiction or any devices intended for implantation in the human body. Should Buyer purchase or use ON Semiconductor products for any such unintended or unauthorized application, Buyer shall indemnify and hold ON Semiconductor and its officers, employees, subsidiaries, affiliates, and distributors harmless against all claims, costs, damages, and expenses, and reasonable attorney fees arising out of, directly or indirectly, any claim of personal injury or death associated with such unintended or unauthorized use, even if such claim alleges that ON Semiconductor was negligent regarding the design or manufacture of the part. ON Semiconductor is an Equal Opportunity/Affirmative Action Employer. This literature is subject to all applicable copyright laws and is not for resale in any manner.

FAN2012

1.5 A Low-Voltage, Current-Mode Synchronous PWM Buck Regulator

Features

- 95% Efficiency, Synchronous Operation
- Adjustable Output Voltage from 0.8 V to 3.5 V
- 4.5 V to 5.5 V Input Voltage Range
- Up to 1.5 A Output Current
- Fixed-Frequency 1.3 MHz PWM Operation
- Soft Start
- Excellent Load Transient Response
- 3 x 3 mm, 6-Lead, MLP

Applications

- Hard Disk Drive
- Set-Top Box
- Point-of-Load Power
- Notebook Computer
- Communications Equipment

Description

The FAN2012 is a high-efficiency, low-noise, synchronous Pulse Width Modulated (PWM) current-mode DC-DC converter designed for low-voltage applications. It provides up to 1.5 A continuous-load current from the 4.5 V to 5.5 V input. The output voltage is adjustable over a wide range of 0.8 V to 3.5 V by means of an external voltage divider.

The FAN2012 has an “Enable Input” and the device can be put in shutdown mode, in which the ground current falls below 1 μ A.

A current-mode control loop with a fast transient response ensures excellent line and load regulation. The fixed 1.3 MHz switching frequency enables designers to choose a small, inexpensive external inductor and capacitor. Filtering is easily accomplished with very small components.

Protection features include input under-voltage lockout, short-circuit protection, and thermal shutdown. Soft-start limits inrush current during start-up conditions.

The device is available in a 3x3 mm 6-lead molded leadless package (MLP), making it possible to build a 1.5 A complete DC-DC converter in limited space on the printed circuit board (PCB).

Ordering Information

Part Number	Output Voltage	Operating Temperature Range	Package
FAN2012MPX	Adjustable	0°C to 85°C	3x3 mm 6-Lead MLP
FAN2012EMPX	Adjustable	-40°C to 85°C	3x3 mm 6-Lead MLP

Typical Application

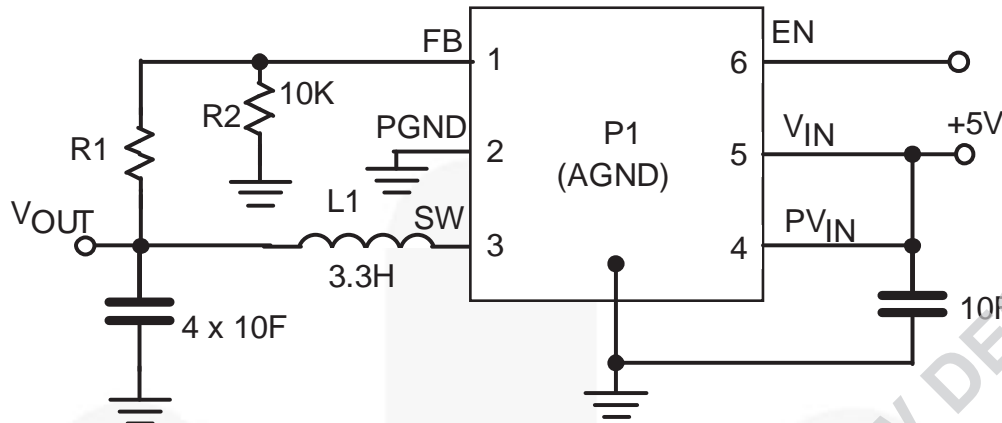

Figure 1. Typical Application

Pin Configuration

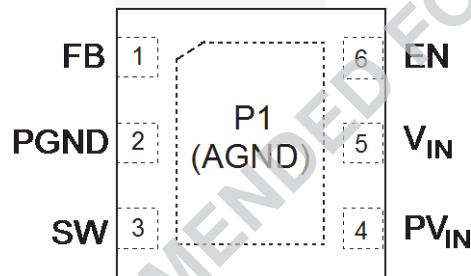

Figure 2. Pin Assignments

Pin Definitions

Pin #	Name	Description
P1	AGND	Analog Ground. P1 must be soldered to the PCB ground.
1	FB	Feedback Input. Adjustable voltage option; connect this pin to the resistor divider.
2	PGND	Power Ground. This pin is connected to the internal MOSFET switches. This pin must be externally connected to AGND.
3	SW	Switching Node. This pin is connected to the internal MOSFET switches.
4	PVIN	Supply Voltage Input. This pin is connected to the internal MOSFET switches.
5	VIN	Supply Voltage Input.
6	EN	Enable Input. Logic HIGH enables the chip and logic LOW disables the chip, reducing the supply current to less than 1 μ A. Do not float this pin.

Absolute Maximum Ratings

Stresses exceeding the absolute maximum ratings may damage the device. The device may not function or be operable above the recommended operating conditions and stressing the parts to these levels is not recommended. In addition, extended exposure to stresses above the recommended operating conditions may affect device reliability. The absolute maximum ratings are stress ratings only.

Symbol	Parameter	Min.	Max.	Unit
V _{IN}	Input Voltage	-0.3	6.5	V
V _{IN}	Input Voltage on PVIN and Any Other Pin	-0.3	V _{IN}	V
θ _{JC}	Thermal Resistance-Junction to Tab ⁽¹⁾		8	°C/W
T _L	Lead Soldering Temperature (10 Seconds)		260	°C
T _{STG}	Storage Temperature	-65	150	°C
T _J	Junction Temperature	-40	150	°C
ESD	Electrostatic Discharge Protection Level ⁽²⁾	HBM	4	kV
		CDM	2	

Notes:

- Junction-to-ambient thermal resistance, θ_{JA}, is a strong function of PCB material, board thickness, thickness and number of copper planes, number of via used, diameter of via used, available copper surface, and attached heat sink characteristics.
- Using Mil Std. 883E, method 3015.7 (Human Body Model) and EIA/JESD22C101-A (Charged Device Model).

Recommended Operating Conditions

The Recommended Operating Conditions table defines the conditions for actual device operation. Recommended operating conditions are specified to ensure optimal performance to the datasheet specifications. Fairchild does not recommend exceeding them or designing to Absolute Maximum Ratings.

Symbols	Parameter	Min.	Typ.	Max.	Unit
V _{IN}	Supply Voltage Range	4.5		5.5	V
V _{OUT}	Output Voltage Range, Adjustable Version	0.8		3.5	V
I _{OUT}	Output Current			1.5	A
L	Inductor ⁽³⁾		3.3		μH
C _{IN}	Input Capacitor ⁽³⁾		10		μF
C _{OUT}	Output Capacitor ⁽³⁾		4 x 10		μF
T _A	Operating Ambient Temperature Range	FAN2012MPX	0	+85	°C
		FAN2012EMPX	-40	+85	°C

Notes:

- Refer to the *Applications* section for details.

Electrical Characteristics

$V_{IN} = 4.5\text{ V to }5.5\text{ V}$, $V_{OUT} = 1.2\text{ V}$, $I_{OUT} = 200\text{ mA}$, $C_{IN} = 10\text{ }\mu\text{F}$, $C_{OUT} = 4 \times 10\text{ }\mu\text{F}$, $L = 3.3\text{ }\mu\text{H}$, $T_A = 0^\circ\text{C to }+85^\circ\text{C}$, unless otherwise noted. Typical values are at $T_A = 25^\circ\text{C}$.

Symbol	Parameter	Conditions	Min.	Typ.	Max.	Units
V_{IN}	Input Voltage		4.5		5.5	V
I_Q	Quiescent Current	$I_{OUT} = 0\text{ mA}$		7	10	mA
V_{UVLO}	UVLO Threshold	V_{IN} Rising	3.4	3.7	4.0	V
		Hysteresis		150		mV
R_{ON_PMOS}	PMOS On Resistance	$V_{IN} = V_{GS} = 5\text{ V}$		150	290	$\text{m}\Omega$
R_{ON_NMOS}	NMOS On Resistance	$V_{IN} = V_{GS} = 5\text{ V}$		150	290	$\text{m}\Omega$
I_{LIMIT}	P-Channel Current Limit	$4.5\text{ V} < V_{IN} < 5.5\text{ V}$	2.2	2.6	3.5	A
T_{OVP}	Over-Temperature Protection	Rising Temperature		150		$^\circ\text{C}$
		Hysteresis		20		$^\circ\text{C}$
f_{SW}	Switching Frequency		1000	1300	1600	kHz
R_{LINE}	Line Regulation	$V_{IN} = 4.5\text{ to }5.5\text{ V}$, $I_{OUT} = 100\text{ mA}$		0.16		%/V
R_{LOAD}	Load Regulation	$0\text{ mA} \leq I_{OUT} \leq 1500\text{ mA}$		0.2	0.5	%
V_{OUT}	Output Voltage During Load Transition ⁽⁴⁾	I_{OUT} from 700 mA to 100 mA			5	%
		I_{OUT} from 100 mA to 700 mA	-5			%
I_{LEAK}	Reverse Leakage Current into Pin SW	$V_{IN} = \text{Open}$, $EN = \text{GND}$, $V_{SW} = 5.5\text{ V}$		0.1	1.0	μA
V_{REF}	Reference Voltage			0.8		V
V_{OUT}	Output Voltage Accuracy	$V_{IN} = 4.5\text{ to }5.5\text{ V}$, $0\text{ mA} \leq I_{OUT} \leq 1500\text{ mA}$	FAN2012MPX	-2	2	%
			FAN2012EMPX	-3	3	%
I_{SD}	Shutdown Mode Supply Current	$V_{EN} = 0\text{ V}$		0.1	1.0	μA
I_{BIAS}	EN Bias Current				0.1	μA
V_{ENH}	EN HIGH Voltage		1.3			V
V_{ENL}	EN LOW Voltage				0.4	V

Notes:

4. Please refer to the load transient response test waveform shown in Figure 3.

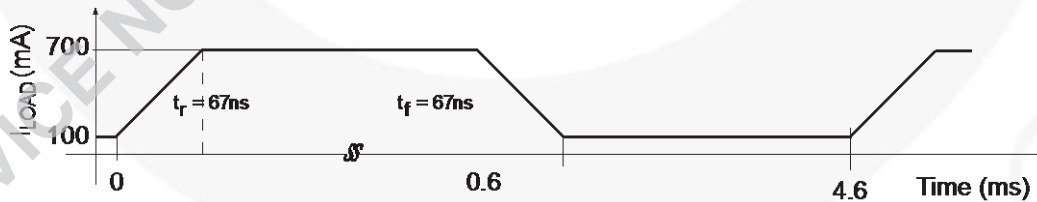

Figure 3. Load Transient Response Test Waveform

Typical Performance Characteristics

$T_A = 25^\circ\text{C}$, $C_{IN} = 10\ \mu\text{F}$, $C_{OUT} = 40\ \mu\text{F}$, $L = 3.3\ \mu\text{H}$, $V_{IN} = 5\ \text{V}$; unless otherwise noted.

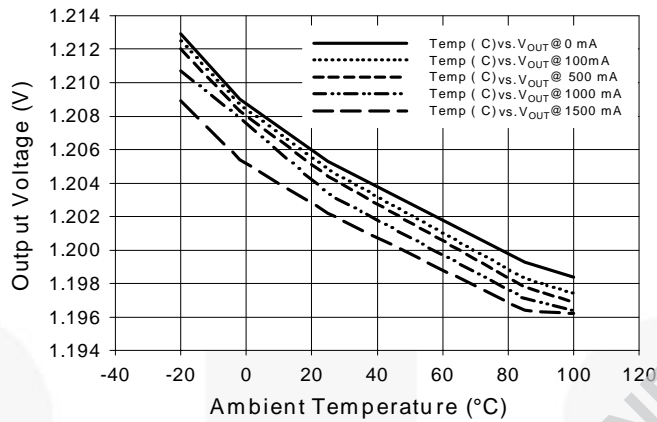

Figure 4. Output Voltage vs. Ambient Temperature

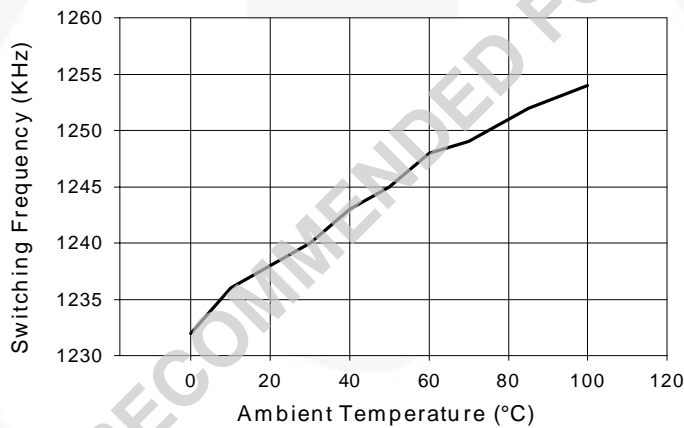

Figure 5. Switching Frequency vs. Ambient Temperature

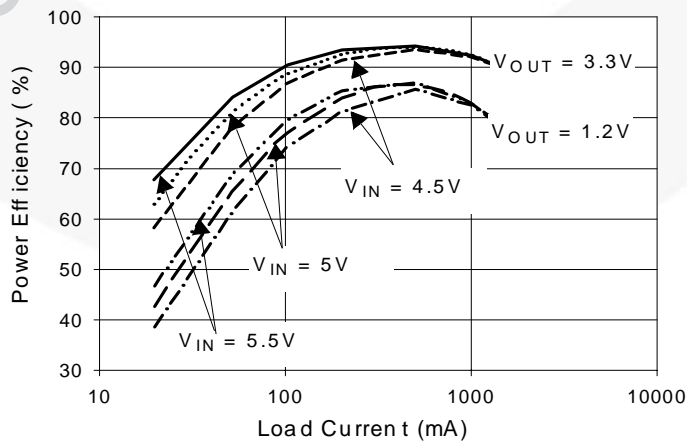

Figure 6. Efficiency vs. Load Current

Typical Performance Characteristics (Continued)

$T_A = 25^\circ\text{C}$, $C_{IN} = 10\ \mu\text{F}$, $C_{OUT} = 40\ \mu\text{F}$, $L = 3.3\ \mu\text{H}$, $V_{IN} = 5\ \text{V}$; unless otherwise noted.

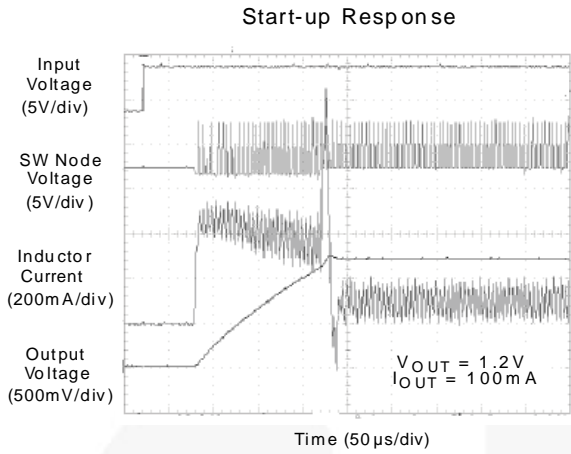

Figure 7. Startup Response

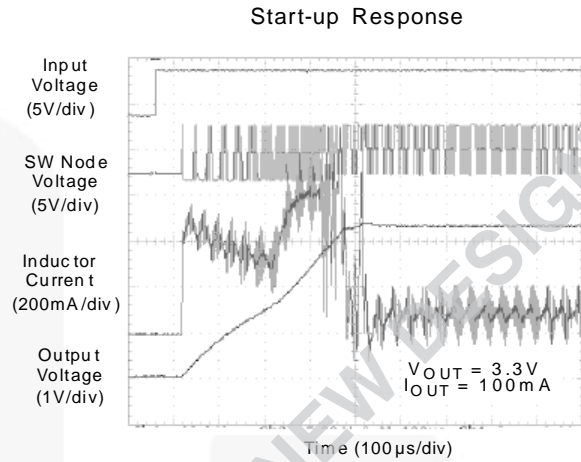

Figure 8. Startup Response

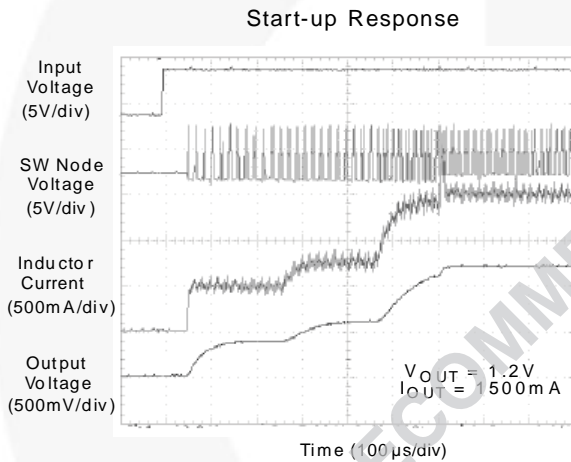

Figure 9. Startup Response

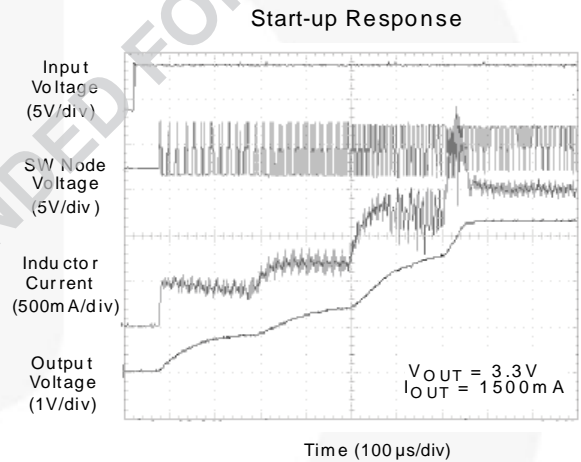

Figure 10. Startup Response

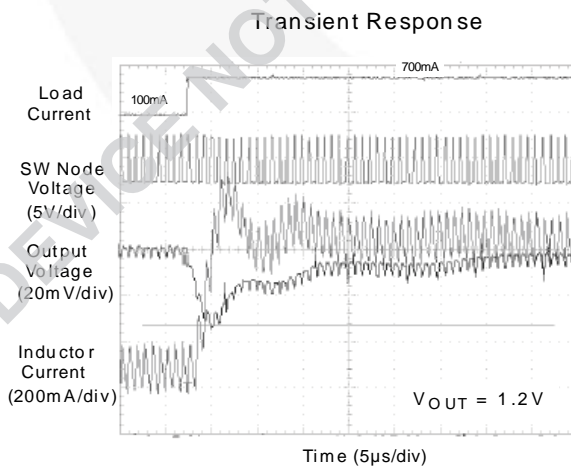

Figure 11. Transient Response

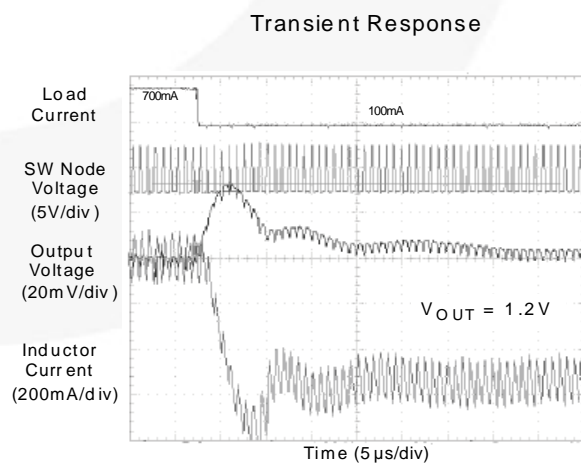

Figure 12. Transient Response

Block Diagram

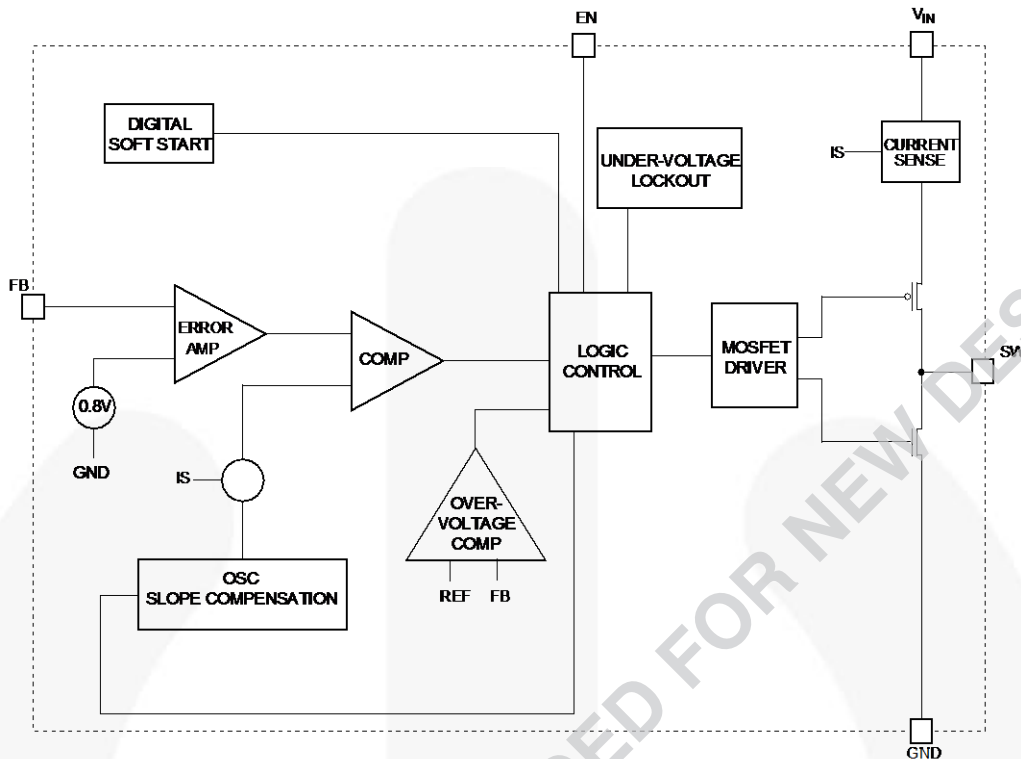

Figure 13. Block Diagram

Detailed Operation Description

The FAN2012 is a step-down pulse width modulated (PWM) current mode converter with a typical switching frequency of 1.3 MHz. At the beginning of each clock cycle, the P-channel transistor is turned on. The inductor current ramps up and is monitored via an internal circuit. The P-channel switch is turned off when the sensed current causes the PWM comparator to trip when the output voltage is in regulation or when the inductor current reaches the current limit (set internally, typically 2600 mA). After a minimum dead time, the N-channel transistor is turned on and the inductor current ramps down. As the clock cycle is completed, the N-channel switch is turned off and the next clock cycle starts. The duty cycle is solely given by the ratio of output voltage and input voltage. Therefore, the converter runs with a minimum duty cycle when output voltage is at minimum and input voltage is at maximum.

UVLO and Soft Start

The reference and the circuit remain reset until the V_{IN} crosses its UVLO threshold.

The FAN2012 has an internal soft-start circuit that limits the in-rush current during start-up. This prevents

possible voltage drops of the input voltage and eliminates the output voltage overshoot. The soft-start is implemented as a digital circuit, increasing the switch current in four steps to the P-channel current limit (2600 mA). Typical start-up time for a 40 μ F output capacitor and a load current of 1500 mA is 800 μ s.

Short-Circuit Protection

The switch peak current is limited cycle by cycle to a typical value of 2600 mA. In the event of an output voltage short circuit, the device operates with a frequency of 400 kHz and minimum-duty cycle, therefore the average input current is typically 350 mA.

Thermal Shutdown

When the die temperature exceeds 150°C, a reset occurs and remains in effect until the die cools to 130°C, at which point, the circuit restarts.

Applications Information

Setting the Output Voltage

The internal voltage reference is 0.8 V. The output is divided down by a voltage divider, R1 and R2 to the FB pin. The output voltage is:

$$V_{OUT} = V_{REF} \left(1 + \frac{R_1}{R_2} \right) \quad \text{EQ. 2}$$

According to this equation, and assuming desired output voltage of 1.5096 V, and given R2 = 10 kΩ, the calculated value of R1 is 8.87 kΩ.

Inductor Selection

The inductor parameters directly related to device performance are saturation current and DC resistance. The FAN2012 operates with a typical inductor value of 3.3 μH. The lower the DC resistance, the higher the efficiency. For saturation current, the inductor should be rated higher than the maximum load current, plus half of the inductor ripple current calculated as follows:

$$\Delta I_L = V_{OUT} \times \frac{1 - (V_{OUT}/V_{IN})}{L \times f} \quad \text{EQ. 3}$$

where:

ΔI_L = Inductor Ripple Current

f = Switching Frequency

L = Inductor Value

Some recommended inductors are suggested in the table below:

Table 1. Recommended Inductors

Inductor Value	Vendor	Part Number
3.3 μH	Panasonic	ELL6PM3R3N
3.3 μH	Murata	LQS66C3R3M04
3.3 μH	Coiltronics	SD-3R3-R

Capacitors Selection

For best performances, a low-ESR input capacitor is required. A ceramic capacitor of at least 10 μF, placed as close to the VIN and AGND pins of the device is recommended. The output capacitor determines the output ripple and the transient response.

Table 2. Recommended Capacitors

Capacitor Value	Vendor	Part Number
10 μF	Taiyo Yuden	JMK212BJ106MG
		JMK316BJ106KL
	TDK	C2012X5ROJ106K
		C3216X5ROJ106M
	Murata	GRM32ER61C106K

PCB Layout Recommendations

The inherently high peak currents and switching frequency of power supplies require a careful PCB layout design. For best results, use wide traces for high-current paths and place the input capacitor, the inductor, and the output capacitor as close as possible to the integrated circuit terminals. To minimize voltage stress to the device resulting from ever-present switching spikes, use an input bypass capacitor with low ESR. Use of an external Schottky diode, with its anode connected to SW node and cathode connected to PVIN, further reduces switching spikes. Note that the peak amplitude of the switching spikes depends upon the load current; the higher the load current, the higher the switching spikes.

The resistor divider that sets the output voltage should be routed away from the inductor to avoid RF coupling. The ground plane at the bottom side of the PCB acts as an electromagnetic shield to reduce EMI. The recommended PCB layout is shown below in Figure 14.

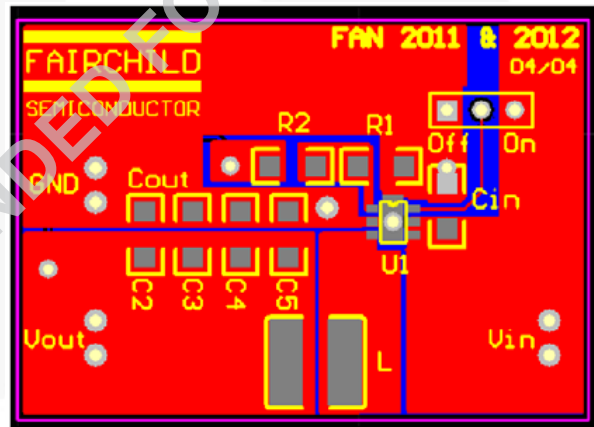
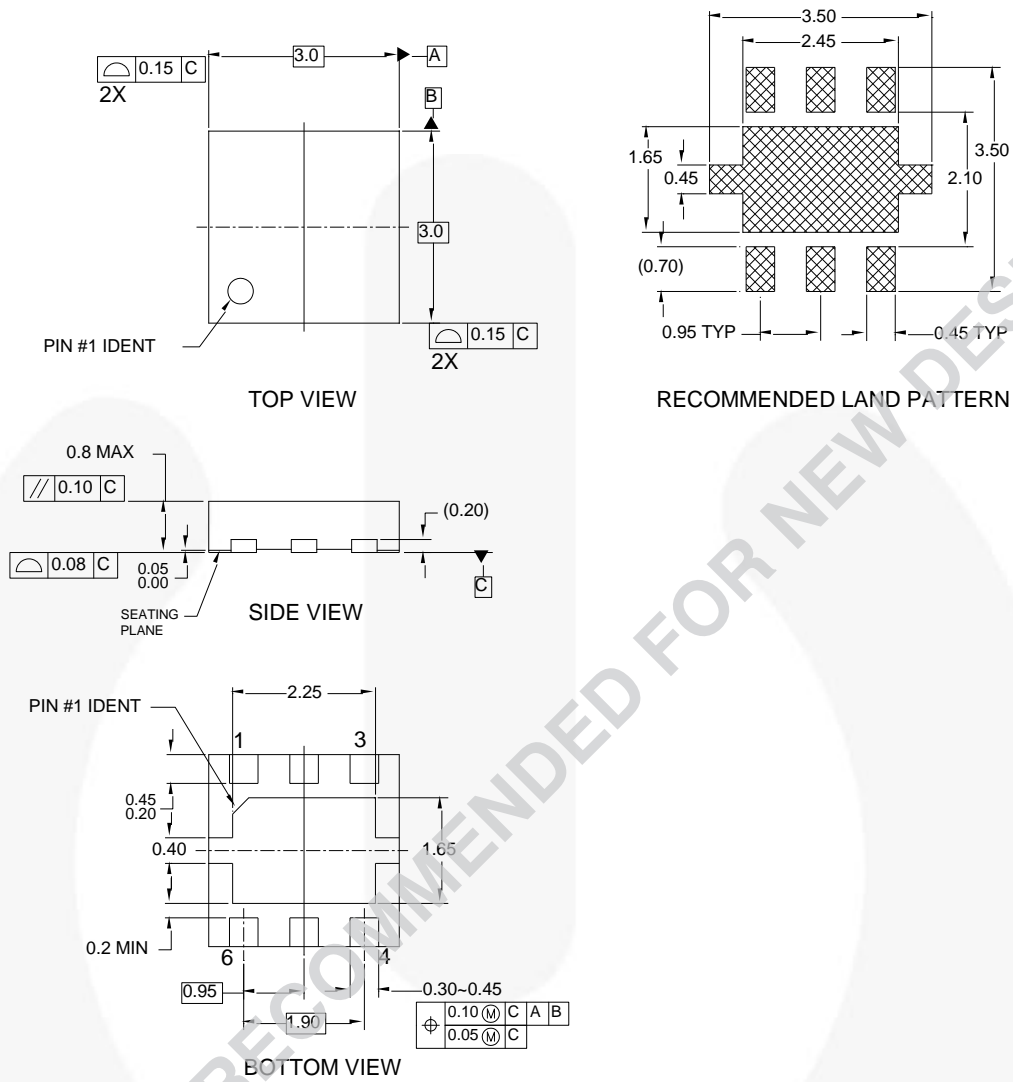

Figure 14. Recommended PCB Layout

Physical Dimensions



NOTES:

- A. CONFORMS TO JEDEC REGISTRATION MO-229, VARIATION WEEA, DATED 11/2001 EXCEPT FOR DAP EXTENSION TABS
- B. DIMENSIONS ARE IN MILLIMETERS.
- C. DIMENSIONS AND TOLERANCES PER ASME Y14.5M, 1994

MLP06FrevA

Figure 15. 3x3 mm, 6-Lead, Molded Leadless Package (MLP)





Package drawings are provided as a service to customers considering Fairchild components. Drawings may change in any manner without notice. Please note the revision and/or date on the drawing and contact a Fairchild Semiconductor representative to verify or obtain the most recent revision. Package specifications do not expand the terms of Fairchild's worldwide terms and conditions, specifically the warranty therein, which covers Fairchild products.

Always visit Fairchild Semiconductor's online packaging area for the most recent package drawings:
<http://www.fairchildsemi.com/dwg/ML/MLP06F.pdf>.



TRADEMARKS

The following includes registered and unregistered trademarks and service marks, owned by Fairchild Semiconductor and/or its global subsidiaries, and is not intended to be an exhaustive list of all such trademarks.

- | | | |
|---|--|---|
| AccuPower™ | F-PFS™ | Sync-Lock™ |
| AX-CAP®* | FRFET® |  SYSTEM GENERAL® |
| BitSiC™ | Global Power Resource™ | TinyBoost® |
| Build it Now™ | GreenBridge™ | TinyBuck® |
| CorePLUS™ | Green FPS™ | TinyCalc™ |
| CorePOWER™ | Green FPS™ e-Series™ | TinyLogic® |
| CROSSVOLT™ | Gmax™ | TINYOPTO™ |
| CTL™ | GTO™ | TinyPower™ |
| Current Transfer Logic™ | IntelliMAX™ | TinyPWM™ |
| DEUXPEED® | ISOPLANAR™ | TinyWire™ |
| Dual Cool™ | Making Small Speakers Sound Louder and Better™ | TransiC™ |
| EcoSPARK® | MegaBuck™ | TriFault Detect™ |
| EfficientMax™ | MICROCOUPLER™ | TRUECURRENT®* |
| ESBC™ | MicroFET™ | µSerDes™ |
|  | MicroPak™ |  SerDes™ |
| Fairchild® | MicroPak2™ | UHC® |
| Fairchild Semiconductor® | MillerDrive™ | Ultra FRFET™ |
| FACT Quiet Series™ | MotionMax™ | UniFET™ |
| FACT® | mWSaver® | VCX™ |
| FAST® | OptoHit™ | VisualMax™ |
| FastvCore™ | OPTOLOGIC® | VoltagePlus™ |
| FETBench™ | OPTOPLANAR® | XSTM |
| FPS™ | | |
| | | PowerTrench® |
| | | PowerXS™ |
| | | Programmable Active Droop™ |
| | | QFET® |
| | | QS™ |
| | | Quiet Series™ |
| | | RapidConfigure™ |
| | |  Saving our world, 1mW/W/kW at a time™ |
| | | SignalWise™ |
| | | SmartMax™ |
| | | SMART START™ |
| | | Solutions for Your Success™ |
| | | SPM® |
| | | STEALTH™ |
| | | SuperFET® |
| | | SuperSOT™-3 |
| | | SuperSOT™-6 |
| | | SuperSOT™-8 |
| | | SupreMOS® |
| | | SyncFET™ |

* Trademarks of System General Corporation, used under license by Fairchild Semiconductor.

DISCLAIMER

FAIRCHILD SEMICONDUCTOR RESERVES THE RIGHT TO MAKE CHANGES WITHOUT FURTHER NOTICE TO ANY PRODUCTS HEREIN TO IMPROVE RELIABILITY, FUNCTION, OR DESIGN. FAIRCHILD DOES NOT ASSUME ANY LIABILITY ARISING OUT OF THE APPLICATION OR USE OF ANY PRODUCT OR CIRCUIT DESCRIBED HEREIN; NEITHER DOES IT CONVEY ANY LICENSE UNDER ITS PATENT RIGHTS, NOR THE RIGHTS OF OTHERS. THESE SPECIFICATIONS DO NOT EXPAND THE TERMS OF FAIRCHILD'S WORLDWIDE TERMS AND CONDITIONS, SPECIFICALLY THE WARRANTY THEREIN, WHICH COVERS THESE PRODUCTS.

LIFE SUPPORT POLICY

FAIRCHILD'S PRODUCTS ARE NOT AUTHORIZED FOR USE AS CRITICAL COMPONENTS IN LIFE SUPPORT DEVICES OR SYSTEMS WITHOUT THE EXPRESS WRITTEN APPROVAL OF FAIRCHILD SEMICONDUCTOR CORPORATION.

As used herein:

- Life support devices or systems are devices or systems which, (a) are intended for surgical implant into the body or (b) support or sustain life, and (c) whose failure to perform when properly used in accordance with instructions for use provided in the labeling, can be reasonably expected to result in a significant injury of the user.
- A critical component in any component of a life support, device, or system whose failure to perform can be reasonably expected to cause the failure of the life support device or system, or to affect its safety or effectiveness.

ANTI-COUNTERFEITING POLICY

Fairchild Semiconductor Corporation's Anti-Counterfeiting Policy. Fairchild's Anti-Counterfeiting Policy is also stated on our external website, www.fairchildsemi.com, under Sales Support.

Counterfeiting of semiconductor parts is a growing problem in the industry. All manufacturers of semiconductor products are experiencing counterfeiting of their parts. Customers who inadvertently purchase counterfeit parts experience many problems such as loss of brand reputation, substandard performance, failed applications, and increased cost of production and manufacturing delays. Fairchild is taking strong measures to protect ourselves and our customers from the proliferation of counterfeit parts. Fairchild strongly encourages customers to purchase Fairchild parts either directly from Fairchild or from Authorized Fairchild Distributors who are listed by country on our web page cited above. Products customers buy either from Fairchild directly or from Authorized Fairchild Distributors are genuine parts, have full traceability, meet Fairchild's quality standards for handling and storage and provide access to Fairchild's full range of up-to-date technical and product information. Fairchild and our Authorized Distributors will stand behind all warranties and will appropriately address any warranty issues that may arise. Fairchild will not provide any warranty coverage or other assistance for parts bought from Unauthorized Sources. Fairchild is committed to combat this global problem and encourage our customers to do their part in stopping this practice by buying direct or from authorized distributors.

PRODUCT STATUS DEFINITIONS

Definition of Terms

Datasheet Identification	Product Status	Definition
Advance Information	Formative / In Design	Datasheet contains the design specifications for product development. Specifications may change in any manner without notice.
Preliminary	First Production	Datasheet contains preliminary data; supplementary data will be published at a later date. Fairchild Semiconductor reserves the right to make changes at any time without notice to improve design.
No Identification Needed	Full Production	Datasheet contains final specifications. Fairchild Semiconductor reserves the right to make changes at any time without notice to improve the design.
Obsolete	Not In Production	Datasheet contains specifications on a product that is discontinued by Fairchild Semiconductor. The datasheet is for reference information only.

Rev. 166

ON Semiconductor and  are trademarks of Semiconductor Components Industries, LLC dba ON Semiconductor or its subsidiaries in the United States and/or other countries. ON Semiconductor owns the rights to a number of patents, trademarks, copyrights, trade secrets, and other intellectual property. A listing of ON Semiconductor's product/patent coverage may be accessed at www.onsemi.com/site/pdf/Patent-Marking.pdf. ON Semiconductor reserves the right to make changes without further notice to any products herein. ON Semiconductor makes no warranty, representation or guarantee regarding the suitability of its products for any particular purpose, nor does ON Semiconductor assume any liability arising out of the application or use of any product or circuit, and specifically disclaims any and all liability, including without limitation special, consequential or incidental damages. Buyer is responsible for its products and applications using ON Semiconductor products, including compliance with all laws, regulations and safety requirements or standards, regardless of any support or applications information provided by ON Semiconductor. "Typical" parameters which may be provided in ON Semiconductor data sheets and/or specifications can and do vary in different applications and actual performance may vary over time. All operating parameters, including "Typicals" must be validated for each customer application by customer's technical experts. ON Semiconductor does not convey any license under its patent rights nor the rights of others. ON Semiconductor products are not designed, intended, or authorized for use as a critical component in life support systems or any FDA Class 3 medical devices or medical devices with a same or similar classification in a foreign jurisdiction or any devices intended for implantation in the human body. Should Buyer purchase or use ON Semiconductor products for any such unintended or unauthorized application, Buyer shall indemnify and hold ON Semiconductor and its officers, employees, subsidiaries, affiliates, and distributors harmless against all claims, costs, damages, and expenses, and reasonable attorney fees arising out of, directly or indirectly, any claim of personal injury or death associated with such unintended or unauthorized use, even if such claim alleges that ON Semiconductor was negligent regarding the design or manufacture of the part. ON Semiconductor is an Equal Opportunity/Affirmative Action Employer. This literature is subject to all applicable copyright laws and is not for resale in any manner.

PUBLICATION ORDERING INFORMATION

LITERATURE FULFILLMENT:

Literature Distribution Center for ON Semiconductor
19521 E. 32nd Pkwy, Aurora, Colorado 80011 USA
Phone: 303-675-2175 or 800-344-3860 Toll Free USA/Canada
Fax: 303-675-2176 or 800-344-3867 Toll Free USA/Canada
Email: orderlit@onsemi.com

N. American Technical Support: 800-282-9855 Toll Free
USA/Canada
Europe, Middle East and Africa Technical Support:
Phone: 421 33 790 2910
Japan Customer Focus Center
Phone: 81-3-5817-1050

ON Semiconductor Website: www.onsemi.com
Order Literature: <http://www.onsemi.com/orderlit>
For additional information, please contact your local
Sales Representative