

Features

- 75 Ω Impedance
- Integrated TTL/CMOS Compatible Driver
- Parallel & Serial (P/S) Control with power-up state selection
- 0.5-dB Attenuation Steps to 31.5 dB
- Low DC Power Consumption
- Lead-Free 4 mm PQFN-24LD Plastic Package
- Halogen-Free “Green” Mold Compound
- RoHS* Compliant and 260°C Re-flow Compatible

Description

The MAAD-008866 is a 6-bit, 0.5-dB step GaAs digital attenuator in a lead-free 4 mm PQFN-24LD surface mount plastic package.

This device is ideally suited for use where high accuracy, very low power consumption and low intermodulation products are required. This part can be used in all 75 Ω systems operating up to 1.218 GHz.

Functional Schematic³

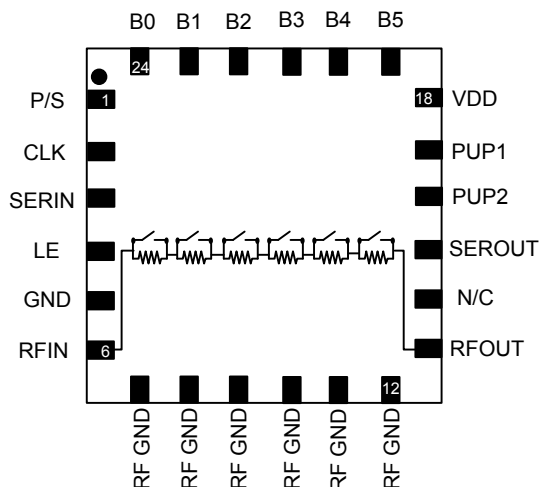

3. Blocking capacitors are required on all RF ports

Pin Configuration

Pin #	Function	Pin #	Function
1	Parallel / Serial Select	16	Power Up State 2
2	Clock	17	Power Up State 1
3	Serial Data In	18	Bias Voltage
4	Latch Enable	19	B5
5	Ground	20	B4
6	RF Input	21	B3
7 - 12	RF Ground	22	B2
13	RF Output	23	B1
14	No Connection	24	B0
15	Serial Data Out	25	Paddle ⁴

4. The exposed pad centered on the package bottom must be connected to the RF and DC ground.

Ordering Information^{1,2}

Part Number	Package
MAAD-008866-TR3000	3000 piece reel
MAAD-008866-001SMB	Sample Board

1. Reference Application Note M513 for reel size information.
2. All sample boards include 5 loose parts.

* Restrictions on Hazardous Substances, European Union Directive 2011/65/EU.

75 Ω Digital Attenuator, 6-Bit, Serial / Parallel Control 31.5 dB, 0.005 - 1.218 GHz

Rev. V4

Electrical Specifications^{5,6}: $T_A = 25^\circ\text{C}$, $Z_0 = 75\ \Omega$, $V_{DD} = 5\ \text{V}$, $V_C = 5\ \text{V}$

Parameter	Test Conditions	Units	Min.	Typ.	Max.
Reference Insertion Loss	5 MHz	dB	—	1.3	—
	50 MHz		—	1.35	—
	500 MHz		—	1.6	—
	1000 MHz		—	1.8	2.3
Attenuation Accuracy	Any Bit or combination 5 - 1000 MHz	± (0.15 dB + 4% of attenuation setting in dB)			
Return Loss	5 - 1000 MHz	dB	—	18	—
T_{RISE} , T_{FALL}	10% to 90% RF, 90% to 10% RF	ns	—	320	—
T_{ON} , T_{OFF}	50% Control to 90 / 10% RF	ns	—	340	—
Transients	In Band	mV	—	88	—
Input P1dB	50 MHz	dBm	—	12	—
	1000 MHz			25.6	
IIP3	0 dBm/tone at Input, 6 MHz Spacing	dBm	—	33	—
	50 MHz			43	
	1000 MHz			—	
IIP2	0 dBm/tone at Input, 6 MHz Spacing	dBm	—	51	—
	50 MHz			74	
	1000 MHz			—	
Composite Triple Beat, CTB	132 channels, +30 dBmV/channel at the input	dBc	—	-88	—
Composite Second Order, CSO	132 channels, +30 dBmV/channel at the input	dBc	—	-69	—
Steady State I_{DD}	$V_{DD} = +5\ \text{V}$	μA	—	4	—

5. External DC blocking capacitors are required on all RF ports. Loss varies at 0.003 dB/°C.

6. Low frequency is determined by DC block and RF GND capacitor value.

Absolute Maximum Ratings^{7,8}

Parameter	Absolute Maximum
Input Power 50 MHz 1000 MHz	+15 dBm +27 dBm
Operating Voltage	+8.5 V
Control Voltage	$-0.5\ \text{V} \leq V_C \leq 5.5\ \text{V}$
Operating Temperature	-40°C to $+85^\circ\text{C}$
Storage Temperature	-65°C to $+150^\circ\text{C}$

7. Exceeding any one or combination of these limits may cause permanent damage to this device.

8. MACOM does not recommend sustained operation near these survivability limits.

Truth Table⁹

B5	B4	B3	B2	B1	B0	Attenuation (dB)
1	1	1	1	1	1	Reference IL
1	1	1	1	1	0	0.5
1	1	1	1	0	1	1
1	1	1	0	1	1	2
1	1	0	1	1	1	4
1	0	1	1	1	1	8
0	1	1	1	1	1	16
0	0	0	0	0	0	31.5

9. Logic "0" = 0 to +0.8 V, Logic "1" = +2 to +5 V.

Recommended PCB

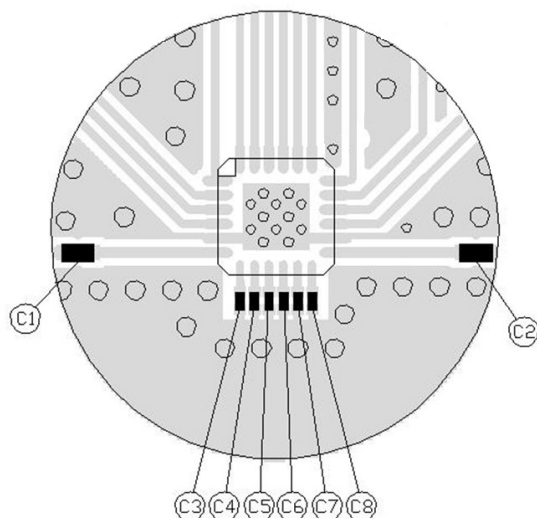

Application¹⁰

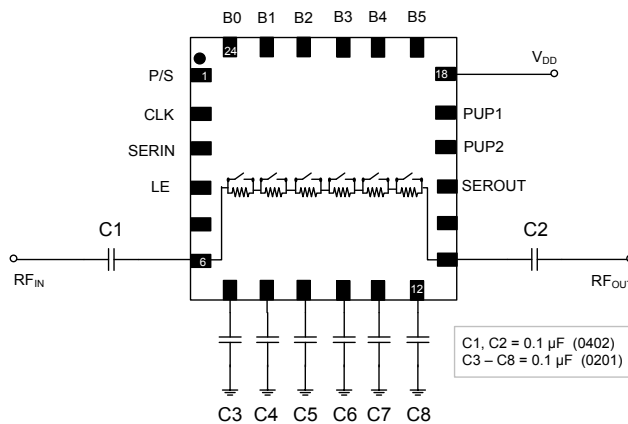

10. Capacitors C3 - C8 should be as close to package pins as possible.

Off-Chip Component Values

Component	Value	Package
C1 & C2	0.1 μ F	0402
C3 - C8	0.1 μ F	0201

Handling Procedures

Please observe the following precautions to avoid damage:

Static Sensitivity

Gallium Arsenide Integrated Circuits are sensitive to electrostatic discharge (ESD) and can be damaged by static electricity. Proper ESD control techniques should be used when handling these devices. An external protection circuit using an inexpensive anti-parallel diode pair can be used to protect the IC.

Please reference application note AN3028 for further detail.

Typical Performance Curves

Insertion Loss

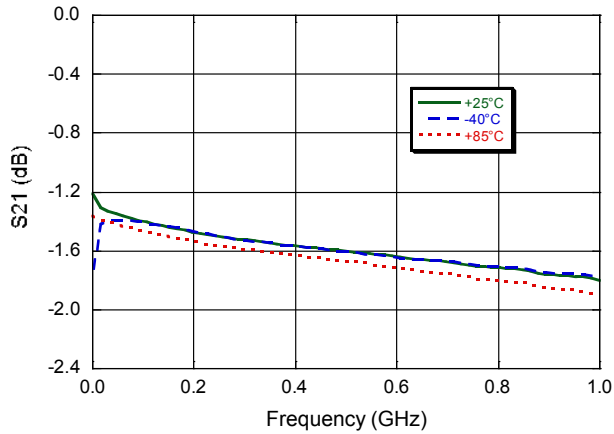

Relative Attenuation across all major states

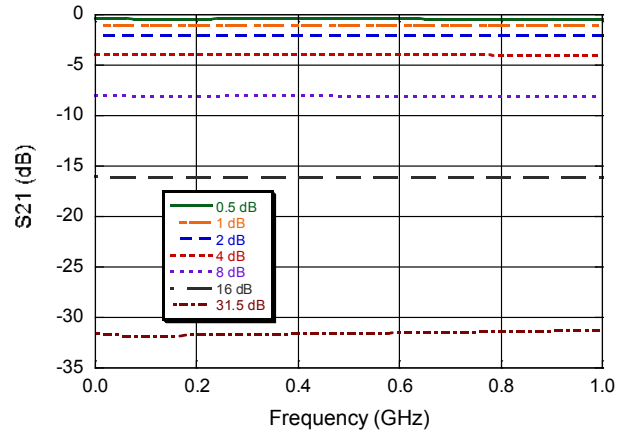

Input Return Loss, across all attenuation states

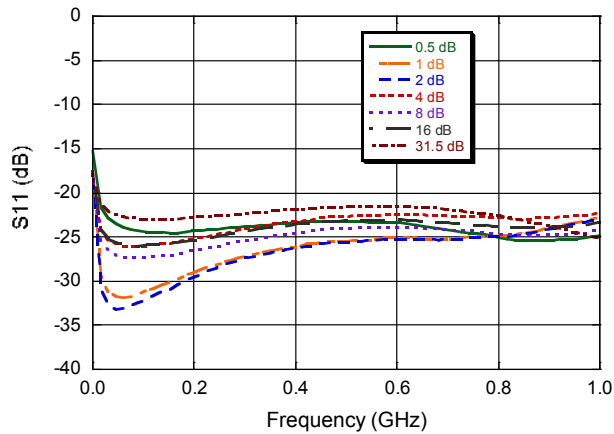

Output Return Loss, across all attenuation states

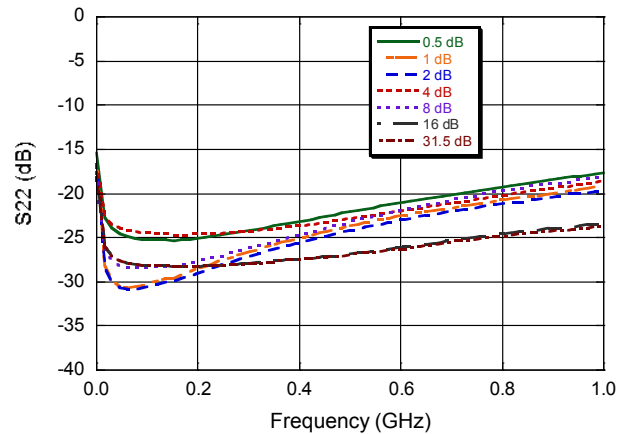

Typical Performance Curves @ 5 Volts

Step Error vs. State over Frequency

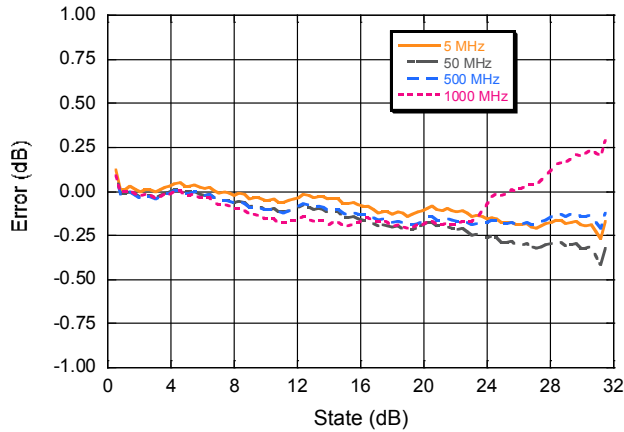

Step Error vs. State over Temp @ 5 MHz

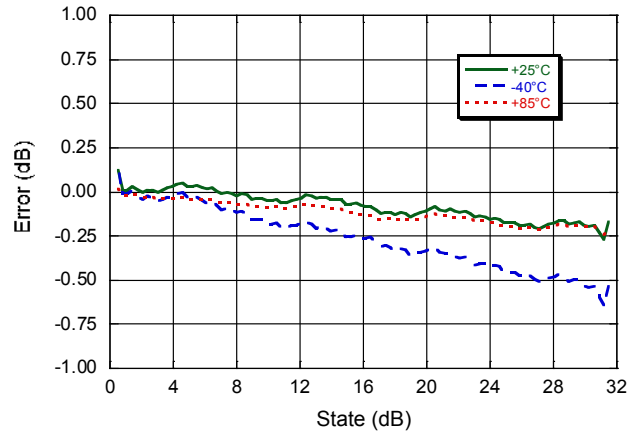

Step Error vs. State over Temp @ 500 MHz

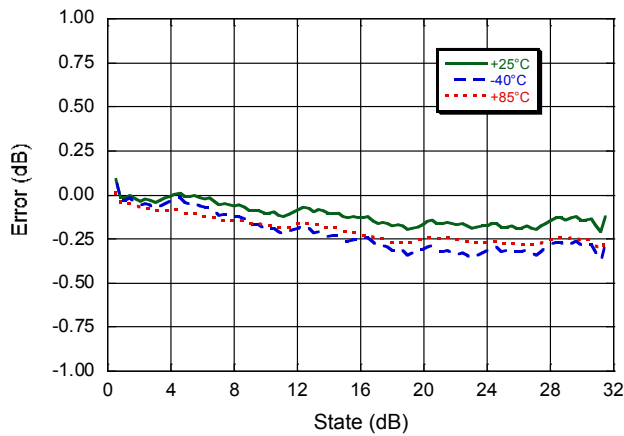

Step Error vs. State over Temp @ 1000 MHz

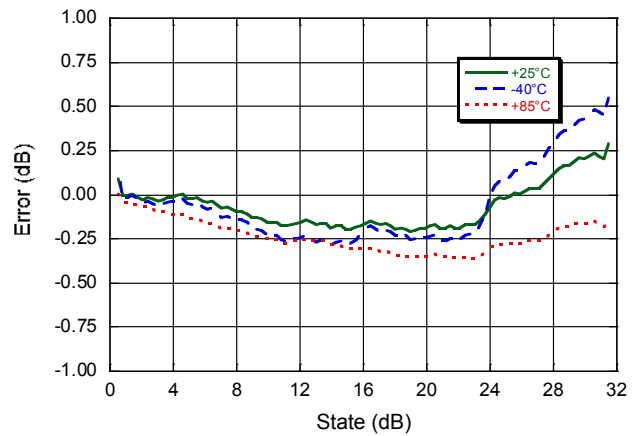

Typical Performance Curves @ 5 Volts

IIP3 vs. Frequency @ 25°C

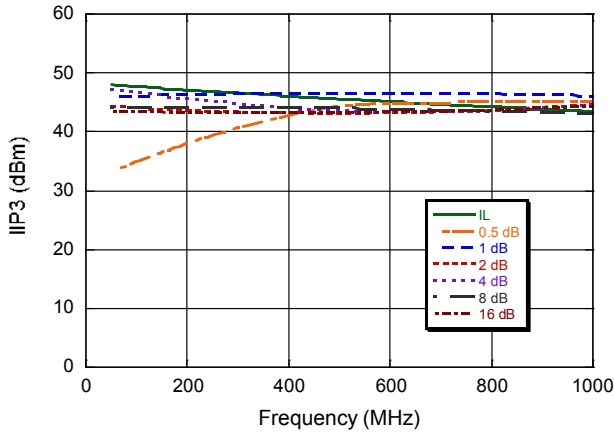

IIP2 vs. Frequency @ 25°C

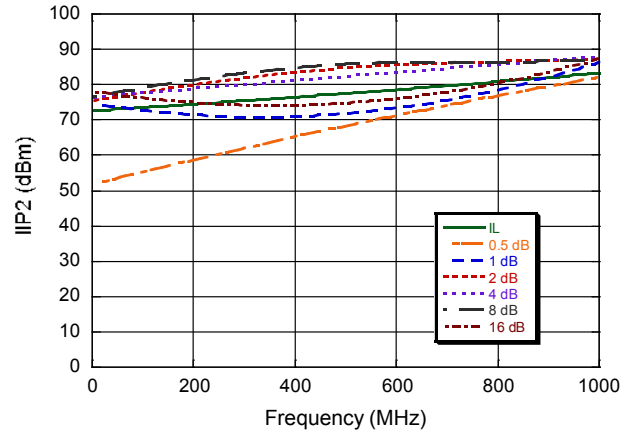

IIP3 vs. Frequency @ -40°C

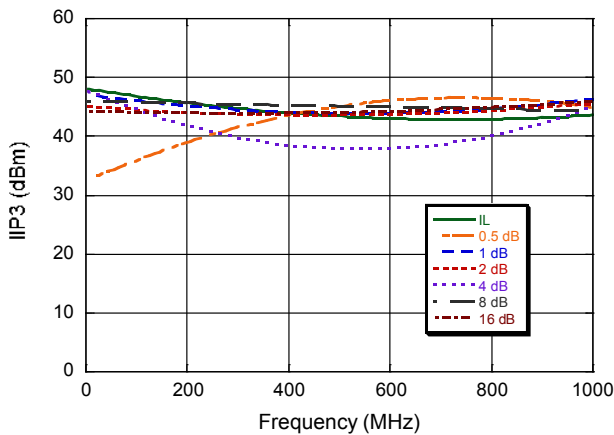

IIP2 vs. Frequency @ -40°C

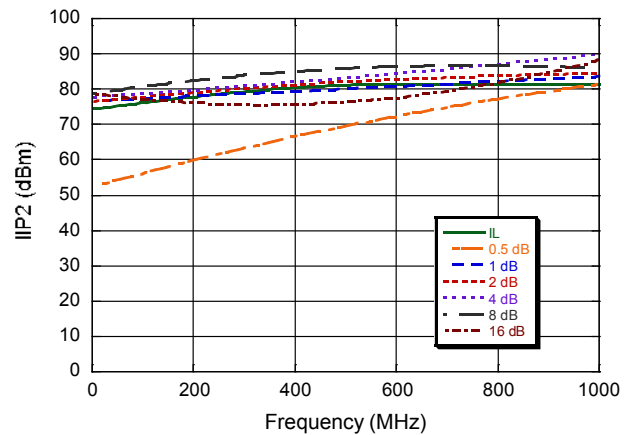

IIP3 vs. Frequency @ +85°C

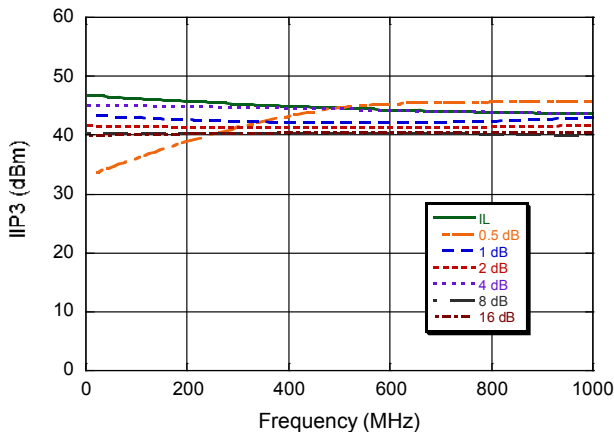

IIP2 vs. Frequency @ +85°C

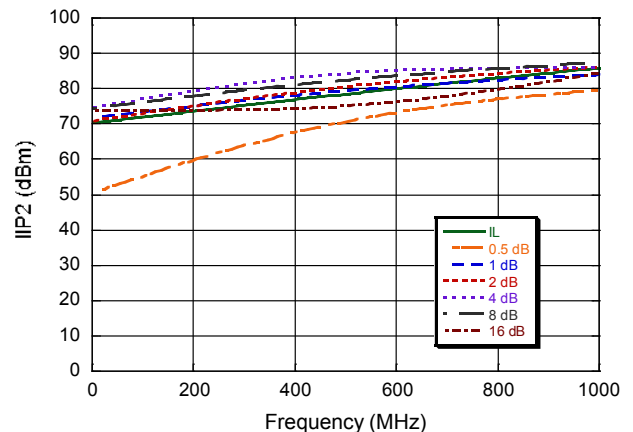

Functionality
Modes of Operation: Serial, Direct Parallel, and Latched Parallel

Mode Truth Table

P/S	LE	Mode
1	X	Serial
0	Constant High	Direct Parallel
0	Pulsed	Latched Parallel

Serial Mode

The serial control interface (SERIN, CLK, LE, SEROUT) is compatible with the SPI protocol. SPI mode is activated when P/S is kept high. The 6-bit serial word must be loaded with MSB first. After shifting in the 6 bit word, bringing LE high will set the attenuator to the desired state. While LE is high the CLK is masked to protect the data while implementing the change. SEROUT is the SERIN delayed by 6 clock cycles.

When P/S is low, the serial control interface is disabled and the serial input register is loaded asynchronously with parallel digital inputs.

Direct Parallel Mode

The parallel mode is enabled when P/S is set to low. In the direct parallel mode, the attenuator is controlled by the parallel control inputs directly. The LE must be at logic high to control the attenuator in this mode.

Latched Parallel Mode

In the latched parallel mode, the parallel control inputs will be buffered by registers, and loaded to the outputs when LE is high. The outputs shall not change states when LE is low.

Power-up States

The power-up (PUP) states will work in both serial and parallel modes, and initiate the attenuator according to the PUP truth table. During power up, the digital inputs shall be held constant for at least 1 μ s after V_{DD} reaches 90% of final value. For serial mode, the PUP states will only work when LE is held low. The PUP state shall be locked out after the first LE pulse.

Functionality
Modes of Operation: Serial, Direct Parallel, and Latched Parallel

PUP Truth Table*

Inputs				Gain Relative to Max. Gain	Notes
PS	LE	PUP2	PUP1		
0	0	0	0	-31.5 dB	Parallel Mode
0	0	0	1	-24 dB	
0	0	1	0	-16 dB	
0	0	1	1	Insertion Loss	
0	1	X	X	0 to -31.5 dB (Set VC0.5 - VC16)	Serial Mode
1	0	X	X	0 to -31.5 dB (Set VC0.5 - VC16)	
1	1	X	X	No Definition	

*V_{DD} T_{RISE} must be <= 125 ns

Serial Interface Timing Characteristics

Symbol	Parameter	Typical Performance			Units
		-40°C	25°C	+85°C	
t _{SCK}	Min. Serial Clock Period	100	100	100	ns
t _{CS}	Min. Control Set-up Time	20	20	20	ns
t _{CH}	Min. Control Hold Time	20	20	20	ns
t _{LS}	Min. LE Set-up Time	10	10	10	ns
t _{LEW}	Min. LE Pulse Width	10	10	10	ns
t _{LH}	Min. Serial Clock Hold Time from LE	10	10	10	ns
t _{LES}	Min. LE Pulse Spacing	630	630	630	ns

Functionality

Modes of Operation: Serial, Direct Parallel, and Latched Parallel

Serial Input Interface Timing Diagram

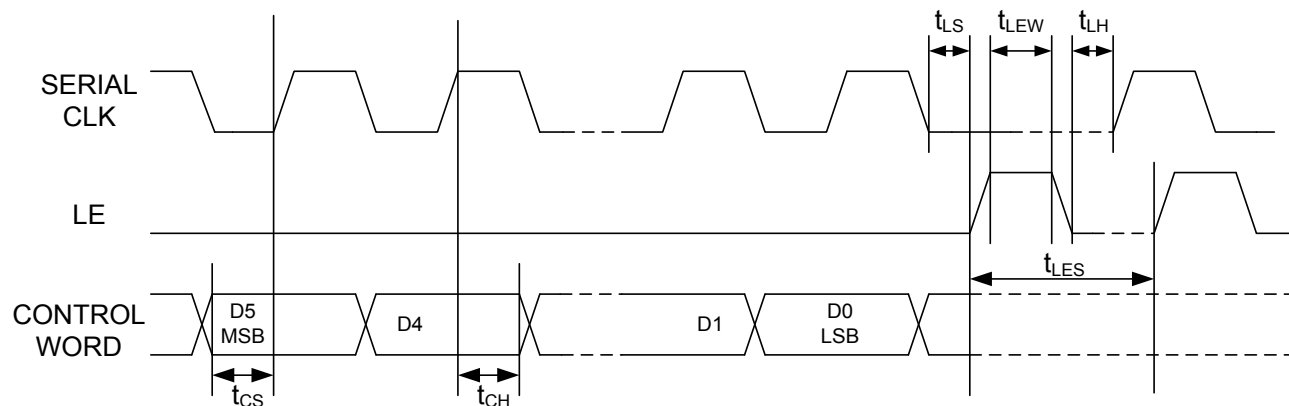

Parallel Control Word

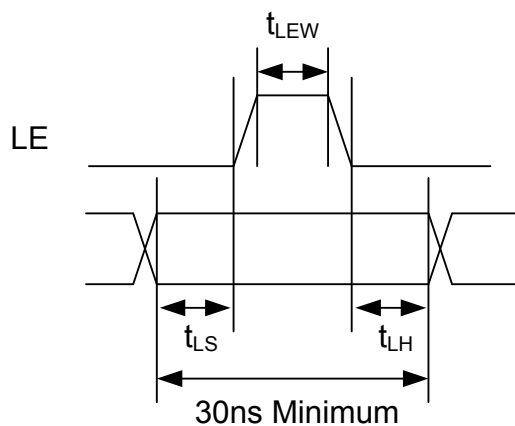

Lead Free 4 mm 24-Lead PQFN †

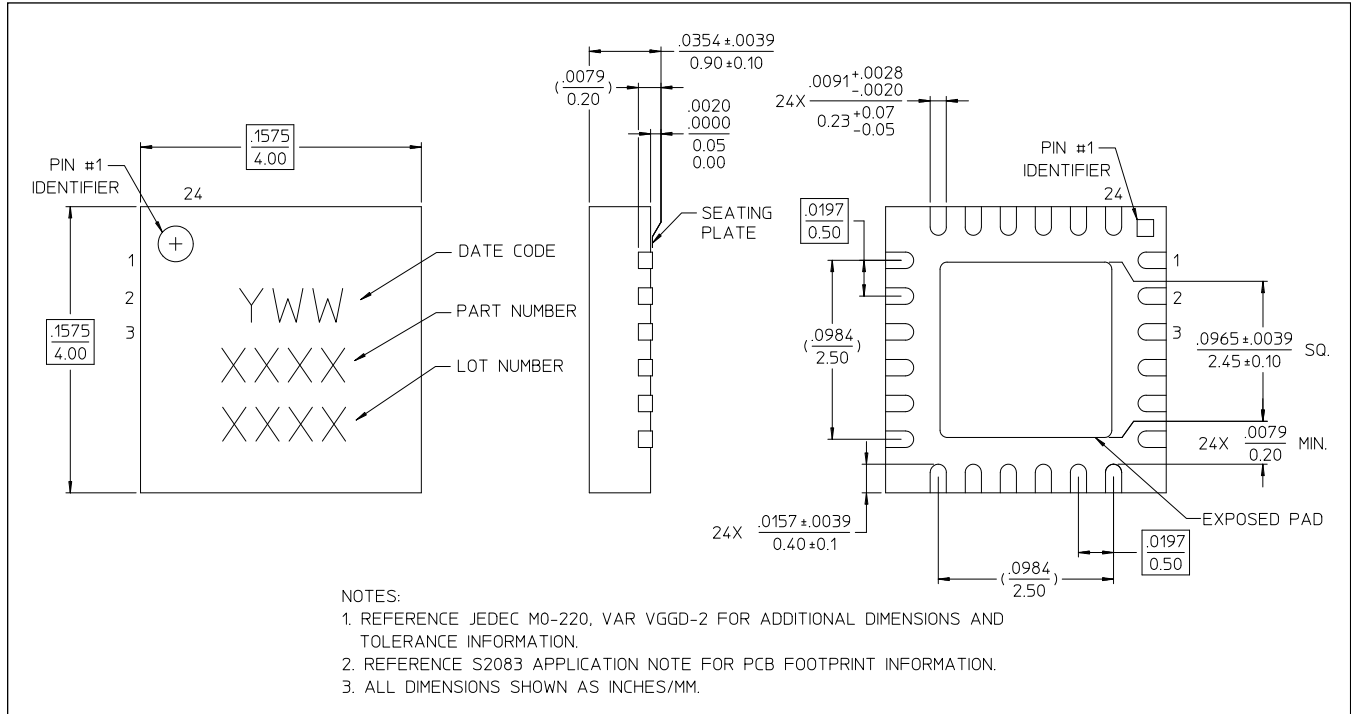

† Reference Application Note M538 for lead-free solder reflow recommendations.
 Meets JEDEC moisture sensitivity level 1 requirements.
 Plating is 100% matte tin over copper.

5 - 1218 MHz Application Section

Electrical Specifications^{5,6}: $T_A = 25^\circ\text{C}$, $Z_0 = 75\ \Omega$, $V_{DD} = 5\ \text{V}$, $V_C = 5\ \text{V}$

Parameter	Test Conditions	Units	Min.	Typ.	Max.
Reference Insertion Loss	5 MHz	dB	—	1.3	—
	50 MHz		—	1.35	—
	500 MHz		—	1.6	—
	1000 MHz		—	1.8	2.3
	1218 MHz		—	1.9	—
Attenuation Accuracy	Any Bit or combination 5 - 1000 MHz	± (0.15 dB + 4% of attenuation setting in dB)			
Return Loss	5 - 1218 MHz	dB	—	18	—
T_{RISE} , T_{FALL}	10% to 90% RF, 90% to 10% RF	ns	—	320	—
T_{ON} , T_{OFF}	50% Control to 90 / 10% RF	ns	—	340	—
Transients	In Band	mV	—	88	—
Input P1dB	50 MHz	dBm	—	12	—
	1000 MHz		—	25.6	—
IIP3	0 dBm/tone at Input, 6 MHz Spacing	dBm	—	33	—
	50 MHz 1000 MHz		—	43	—
IIP2	0 dBm/tone at Input, 6 MHz Spacing	dBm	—	51	—
	50 MHz 1000 MHz		—	74	—
Composite Triple Beat, CTB	132 channels, +30 dBmV/channel at the input	dBc	—	-88	—
Composite Second Order, CSO	132 channels, +30 dBmV/channel at the input	dBc	—	-69	—
Steady State I_{DD}	$V_{DD} = +5\ \text{V}$	μA	—	4	—

5. External DC blocking capacitors are required on all RF ports. Loss varies at 0.003 dB/°C.

6. Low frequency is determined by DC block and RF GND capacitor value.

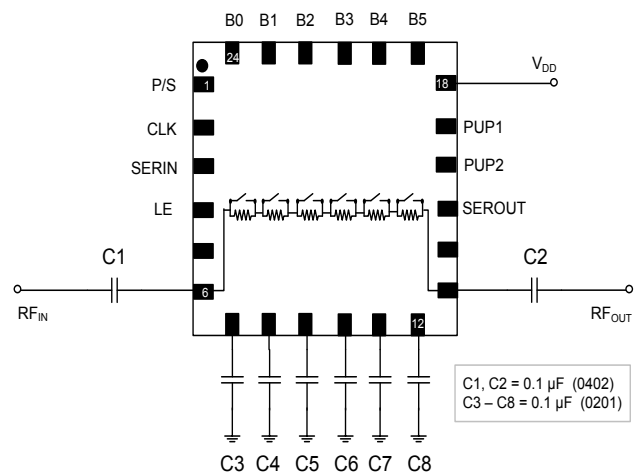
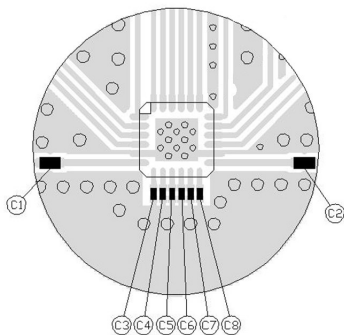

10. Capacitors C3 - C8 should be as close to package pins as possible.

Off-Chip Component Values

Component	Value	Package
C1 & C2	0.1 μF	0402
C3 - C8	0.1 μF	0201

5 - 1218 MHz Application Section

Typical Performance Curves

Insertion Loss

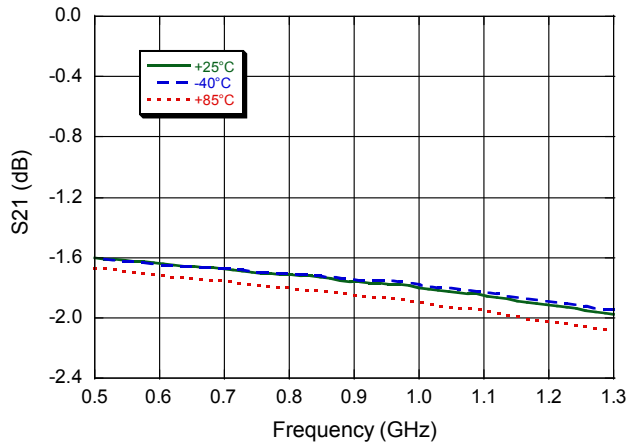

Relative Attenuation across all major states

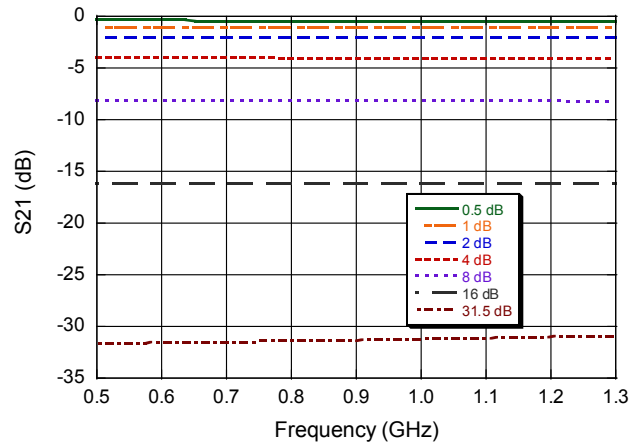

Input Return Loss, across all attenuation states

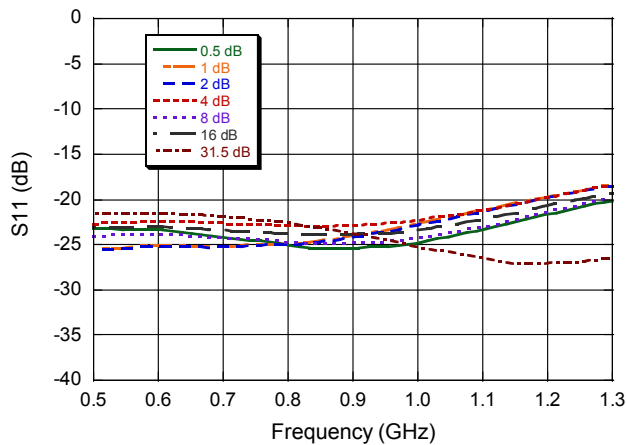

Output Return Loss, across all attenuation states

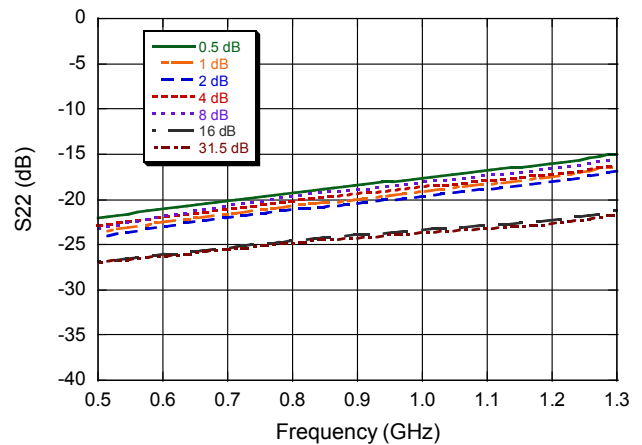

MACOM Technology Solutions Inc. All rights reserved.

Information in this document is provided in connection with MACOM Technology Solutions Inc ("MACOM") products. These materials are provided by MACOM as a service to its customers and may be used for informational purposes only. Except as provided in MACOM's Terms and Conditions of Sale for such products or in any separate agreement related to this document, MACOM assumes no liability whatsoever. MACOM assumes no responsibility for errors or omissions in these materials. MACOM may make changes to specifications and product descriptions at any time, without notice. MACOM makes no commitment to update the information and shall have no responsibility whatsoever for conflicts or incompatibilities arising from future changes to its specifications and product descriptions. No license, express or implied, by estoppel or otherwise, to any intellectual property rights is granted by this document.

THESE MATERIALS ARE PROVIDED "AS IS" WITHOUT WARRANTY OF ANY KIND, EITHER EXPRESS OR IMPLIED, RELATING TO SALE AND/OR USE OF MACOM PRODUCTS INCLUDING LIABILITY OR WARRANTIES RELATING TO FITNESS FOR A PARTICULAR PURPOSE, CONSEQUENTIAL OR INCIDENTAL DAMAGES, MERCHANTABILITY, OR INFRINGEMENT OF ANY PATENT, COPYRIGHT OR OTHER INTELLECTUAL PROPERTY RIGHT. MACOM FURTHER DOES NOT WARRANT THE ACCURACY OR COMPLETENESS OF THE INFORMATION, TEXT, GRAPHICS OR OTHER ITEMS CONTAINED WITHIN THESE MATERIALS. MACOM SHALL NOT BE LIABLE FOR ANY SPECIAL, INDIRECT, INCIDENTAL, OR CONSEQUENTIAL DAMAGES, INCLUDING WITHOUT LIMITATION, LOST REVENUES OR LOST PROFITS, WHICH MAY RESULT FROM THE USE OF THESE MATERIALS.

MACOM products are not intended for use in medical, lifesaving or life sustaining applications. MACOM customers using or selling MACOM products for use in such applications do so at their own risk and agree to fully indemnify MACOM for any damages resulting from such improper use or sale.