

Low Dropout Micropower Linear Regulator with PWRGD

FEATURES

- **Wide Input Voltage Range: 4V to 80V**
- **Low Quiescent Current: 65µA**
- **Low Dropout Voltage: 400mV**
- **Output Current: 250mA**
- No Protection Diodes Needed
- Adjustable Output from 1.24V to 60V
- Stable with 3.3µF Output Capacitor
- Stable with Aluminum, Tantalum or Ceramic Capacitors
- Reverse-Battery Protection
- No Reverse Current Flow from Output to Input
- Thermal Limiting
- Thermally Enhanced 16-Lead TSSOP and 12-Pin (4mm × 3mm) DFN Package

APPLICATIONS

- Low Current High Voltage Regulators
- Regulator for Battery-Powered Systems
- Telecom Applications
- Automotive Applications

LT, LT, LTC and LTM are registered trademarks of Linear Technology Corporation. All other trademarks are the property of their respective owners.

DESCRIPTION

The LT[®]3013B is a high voltage, micropower low dropout linear regulator. The device is capable of supplying 250mA of output current with a dropout voltage of 400mV. Designed for use in battery-powered or high voltage systems, the low quiescent current (65µA operating) makes the LT3013B an ideal choice. Quiescent current is also well controlled in dropout.

Other features of the LT3013B include a PWRGD flag to indicate output regulation. The delay between regulated output level and flag indication is programmable with a single capacitor. The LT3013B also has the ability to operate with very small output capacitors. The regulator is stable with only 3.3µF on the output while most older devices require between 10µF and 100µF for stability. Small ceramic capacitors can be used without any need for series resistance (ESR) as is common with other regulators. Internal protection circuitry includes reverse-battery protection, current limiting, thermal limiting and reverse-current protection.

The device is available with an adjustable output with a 1.24V reference voltage. The LT3013B regulator is available in the thermally enhanced 16-lead TSSOP and the low profile (0.75mm), 12-pin (4mm × 3mm) DFN package, both providing excellent thermal characteristics.

TYPICAL APPLICATION

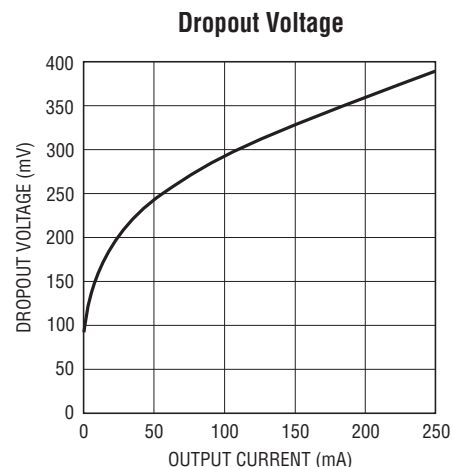
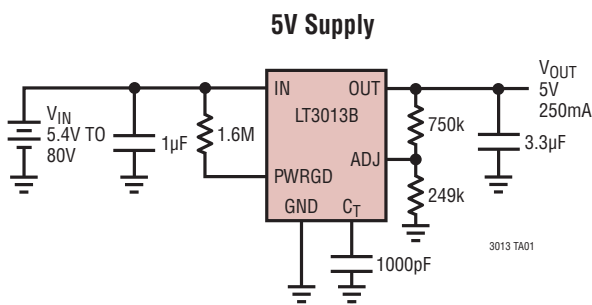

3013 TA02

3013bfb

LT3013B

ABSOLUTE MAXIMUM RATINGS (Note 1)

IN Pin Voltage	±80V	Storage Temperature Range	
OUT Pin Voltage	±60V	TSSOP Package	−65°C to 150°C
IN to OUT Differential Voltage	±80V	DFN Package	−65°C to 125°C
ADJ Pin Voltage	±7V	Operating Junction Temperature Range	
C _T Pin Voltage	7V, −0.5V	(Notes 3, 9, 10)	−40°C to 125°C
PWRGD Pin Voltage	80V, −0.5V	Lead Temperature (Soldering, 10 sec)	
Output Short-Circuit Duration	Indefinite	TSSOP Only	300°C

PIN CONFIGURATION

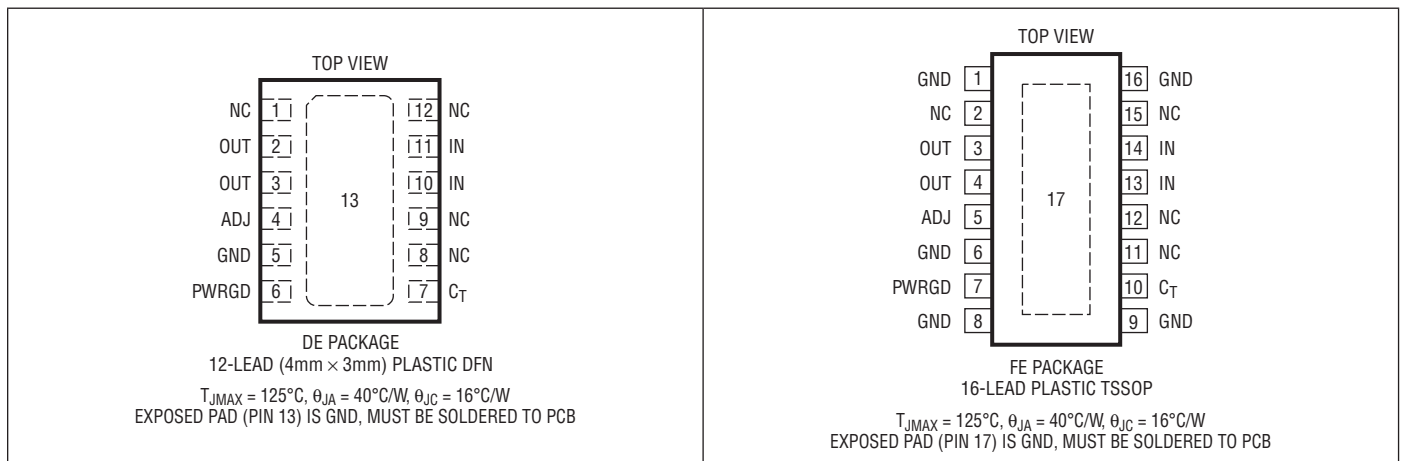

ORDER INFORMATION

LEAD FREE FINISH	TAPE AND REEL	PART MARKING	PACKAGE DESCRIPTION	TEMPERATURE RANGE
LT3013BEDE#PBF	LT3013BEDE#TRPBF	3013B	12-Lead (4mm × 3mm) Plastic DFN	−40°C to 125°C
LT3013BEFE#PBF	LT3013BEFE#TRPBF	3013BEFE	16-Lead Plastic TSSOP	−40°C to 125°C
LEAD BASED FINISH	TAPE AND REEL	PART MARKING	PACKAGE DESCRIPTION	TEMPERATURE RANGE
LT3013BEDE	LT3013BEDE#TR	3013B	12-Lead (4mm × 3mm) Plastic DFN	−40°C to 125°C
LT3013BEFE	LT3013BEFE#TR	3013BEFE	16-Lead Plastic TSSOP	−40°C to 125°C

Consult LTC Marketing for parts specified with wider operating temperature ranges.

For more information on lead free part marking, go to: <http://www.linear.com/leadfree/>

For more information on tape and reel specifications, go to: <http://www.linear.com/tapeandreeel/>

ELECTRICAL CHARACTERISTICS

The ● denotes the specifications which apply over the full operating temperature range, otherwise specifications are at $T_J = 25^\circ\text{C}$.

PARAMETER	CONDITIONS		MIN	TYP	MAX	UNITS
Minimum Input Voltage	$I_{LOAD} = 250\text{mA}$	●		4	4.5	V
ADJ Pin Voltage (Notes 2, 3)	$V_{IN} = 4\text{V}, I_{LOAD} = 1\text{mA}$		1.225	1.24	1.255	V
	$4.5\text{V} < V_{IN} < 80\text{V}, 1\text{mA} < I_{LOAD} < 250\text{mA}$	●	1.2	1.24	1.28	V
Line Regulation	$\Delta V_{IN} = 4\text{V to } 80\text{V}, I_{LOAD} = 1\text{mA}$ (Note 2)	●		0.1	5	mV
Load Regulation (Note 2)	$V_{IN} = 4.5\text{V}, \Delta I_{LOAD} = 1\text{mA to } 250\text{mA}$	●		7	12	mV
	$V_{IN} = 4.5\text{V}, \Delta I_{LOAD} = 1\text{mA to } 250\text{mA}$				25	mV
Dropout Voltage $V_{IN} = V_{OUT(NOMINAL)}$ (Notes 4, 5)	$I_{LOAD} = 10\text{mA}$			160	230	mV
	$I_{LOAD} = 10\text{mA}$	●			300	mV
	$I_{LOAD} = 50\text{mA}$ $I_{LOAD} = 50\text{mA}$	●		250	340	mV
GND Pin Current $V_{IN} = 4.5\text{V}$ (Notes 4, 6)	$I_{LOAD} = 0\text{mA}$	●		65	120	μA
	$I_{LOAD} = 100\text{mA}$			3		mA
	$I_{LOAD} = 250\text{mA}$	●		10	18	mA
Output Voltage Noise	$C_{OUT} = 10\mu\text{F}, I_{LOAD} = 250\text{mA}, \text{BW} = 10\text{Hz to } 100\text{kHz}$			100		μV_{RMS}
ADJ Pin Bias Current	(Note 7)			30	100	nA
PWRGD Trip Point	% of Nominal Output Voltage, Output Rising	●	85	90	94	%
PWRGD Trip Point Hysteresis	% of Nominal Output Voltage			1.1		%
PWRGD Output Low Voltage	$I_{PWRGD} = 50\mu\text{A}$	●		140	250	mV
C_T Pin Charging Current				3.6	6	μA
C_T Pin Voltage Differential	$V_{CT(PWRGD\ High)} - V_{CT(PWRGD\ Low)}$			1.6		V
Ripple Rejection	$V_{IN} = 7\text{V(Avg)}, V_{RIPPLE} = 0.5\text{V}_{P-P}, f_{RIPPLE} = 120\text{Hz}, I_{LOAD} = 250\text{mA}$		65	75		dB
Current Limit	$V_{IN} = 7\text{V}, V_{OUT} = 0\text{V}$			400		mA
	$V_{IN} = 4.5\text{V}, \Delta V_{OUT} = -0.1\text{V}$ (Note 2)	●	270			mA
Reverse Output Current (Note 8)	$V_{OUT} = 1.24\text{V}, V_{IN} < 1.24\text{V}$ (Note 2)			12	25	μA

Note 1: Stresses beyond those listed under Absolute Maximum Ratings may cause permanent damage to the device. Exposure to any Absolute Maximum Rating condition for extended periods may affect device reliability and lifetime.

Note 2: The LT3013B is tested and specified for these conditions with the ADJ pin connected to the OUT pin.

Note 3: Operating conditions are limited by maximum junction temperature. The regulated output voltage specification will not apply for all possible combinations of input voltage and output current. When operating at maximum input voltage, the output current range must be limited. When operating at maximum output current, the input voltage range must be limited.

Note 4: To satisfy requirements for minimum input voltage, the LT3013B is tested and specified for these conditions with an external resistor divider (249k bottom, 549k top) for an output voltage of 4V. The external resistor divider will add a 5 μA DC load on the output.

Note 5: Dropout voltage is the minimum input to output voltage differential needed to maintain regulation at a specified output current. In dropout, the output voltage will be equal to $(V_{IN} - V_{DROPOUT})$.

Note 6: GND pin current is tested with $V_{IN} = 4.5\text{V}$ and a current source load. This means the device is tested while operating close to its dropout region. This is the worst-case GND pin current. The GND pin current will decrease slightly at higher input voltages.

Note 7: ADJ pin bias current flows into the ADJ pin.

Note 8: Reverse output current is tested with the IN pin grounded and the OUT pin forced to the rated output voltage. This current flows into the OUT pin and out the GND pin.

Note 9: The LT3013BE is guaranteed to meet performance specifications from 0°C to 125°C operating junction temperature. Specifications over the -40°C to 125°C operating junction temperature range are assured by design, characterization and correlation with statistical process controls.

Note 10: This IC includes overtemperature protection that is intended to protect the device during momentary overload conditions. Junction temperature will exceed 125°C when overtemperature protection is active. Continuous operation above the specified maximum operating junction temperature may impair device reliability.

TYPICAL PERFORMANCE CHARACTERISTICS

Typical Dropout Voltage

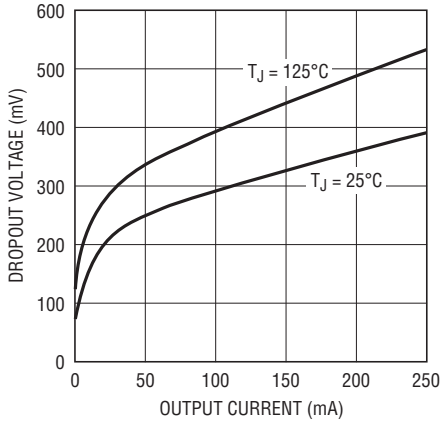

3013 G01

Guaranteed Dropout Voltage

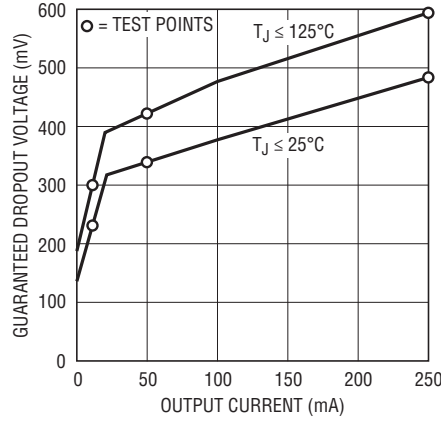

3013 G02

Dropout Voltage

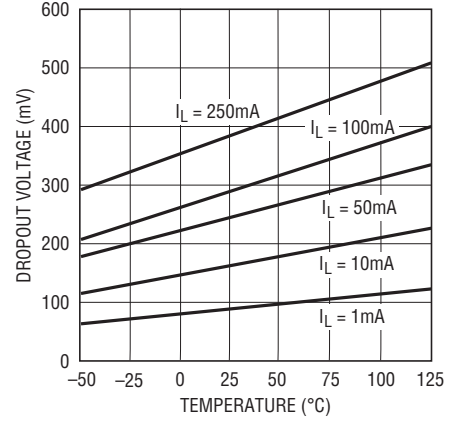

3013 G03

Quiescent Current

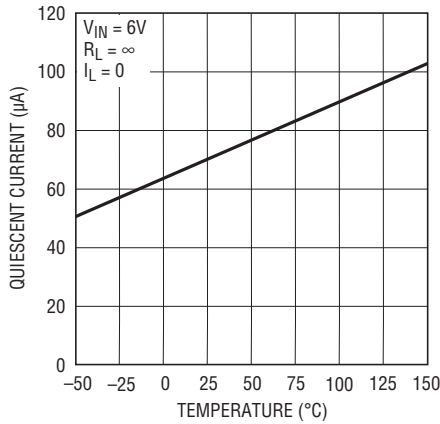

3013 G04

ADJ Pin Voltage

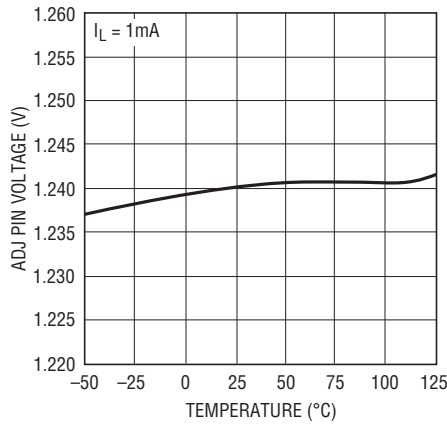

3013 G05

Quiescent Current

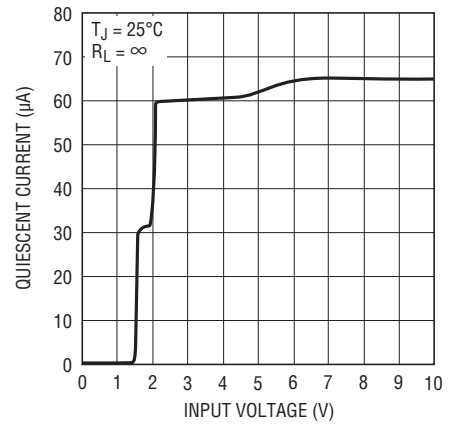

3013 G06

Quiescent Current

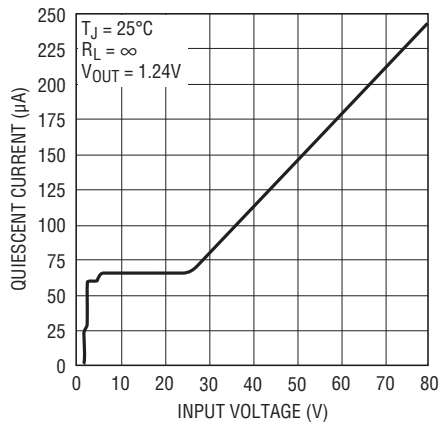

3013 G06b

GND Pin Current

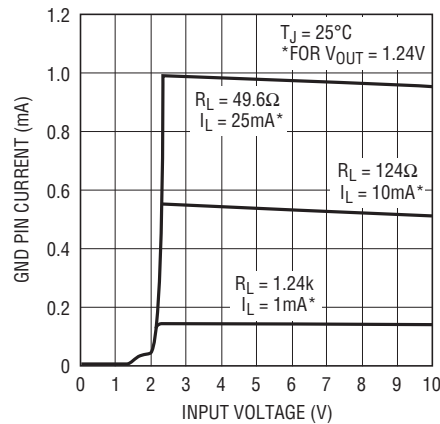

3013 G07

GND Pin Current

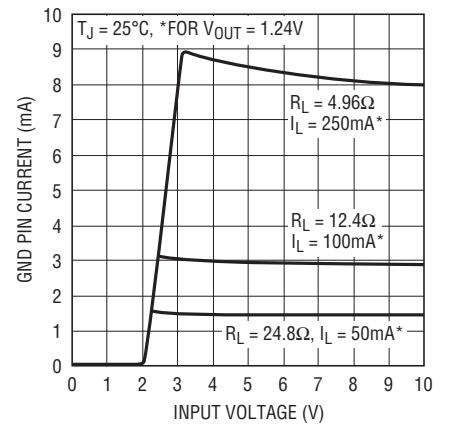

3013 G08

TYPICAL PERFORMANCE CHARACTERISTICS

GND Pin Current vs I_{LOAD}

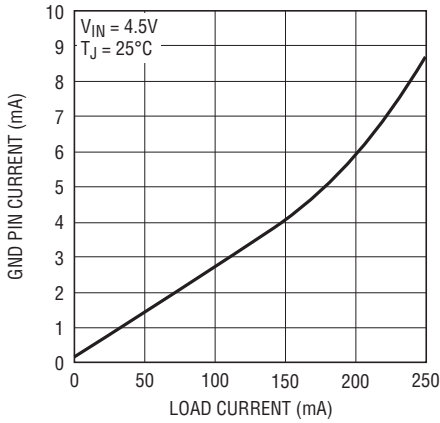

3013 G09

ADJ Pin Bias Current

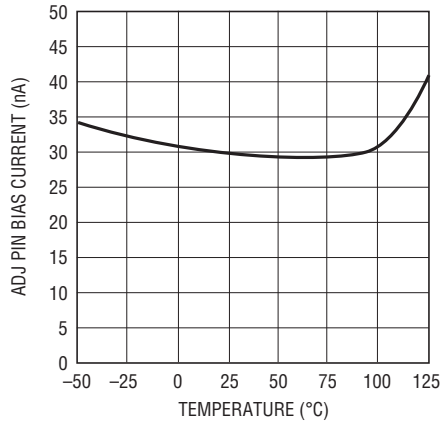

3013 G13

PWRGD Trip Point

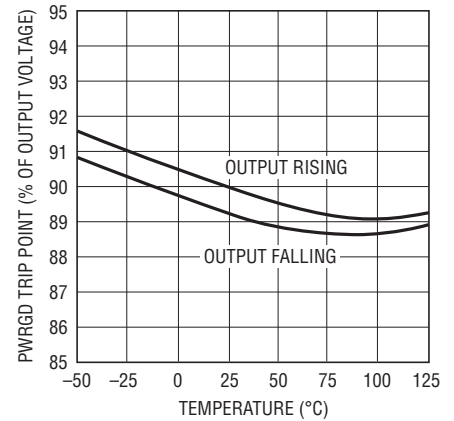

3013 G25

PWRGD Output Low Voltage

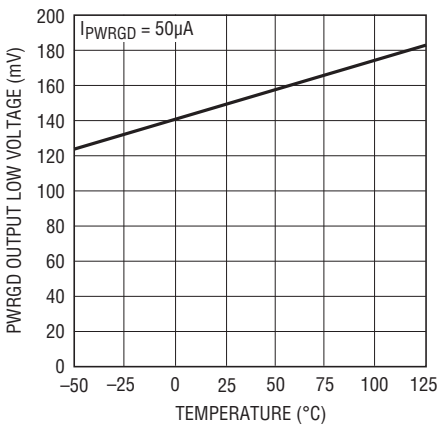

3013 G26

C_T Charging Current

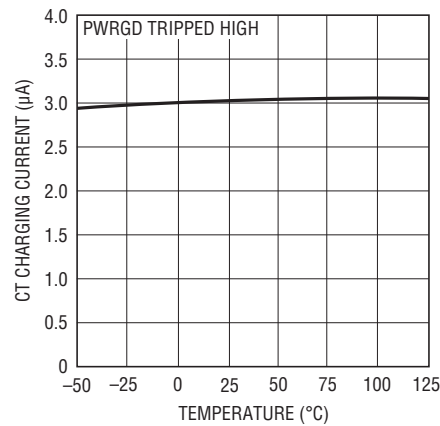

3013 G27

C_T Comparator Thresholds

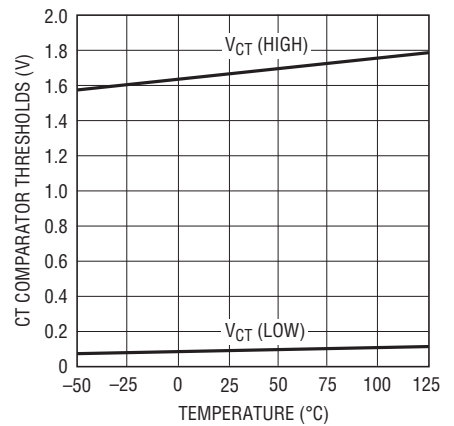

3013 G28

Current Limit

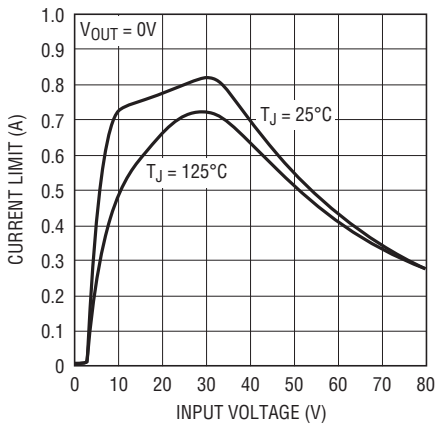

3013 G14

Current Limit

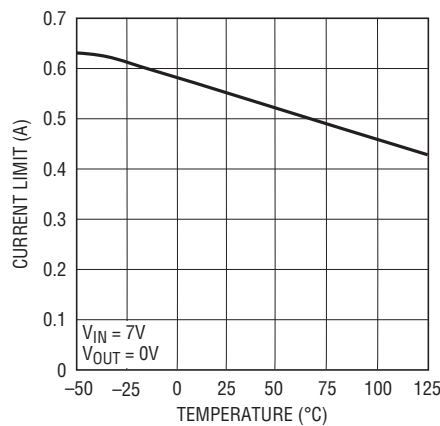

3013 G15

Reverse Output Current

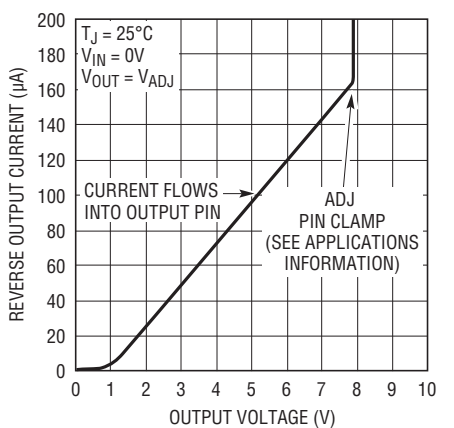

3013 G16

TYPICAL PERFORMANCE CHARACTERISTICS

Reverse Output Current

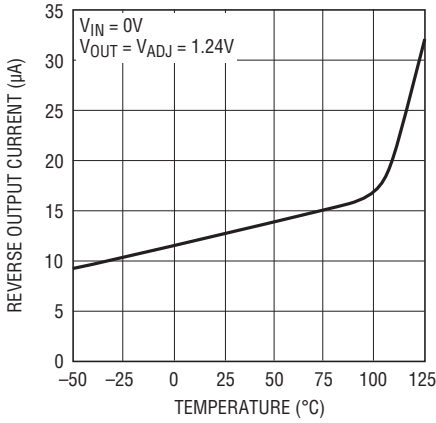

Input Ripple Rejection

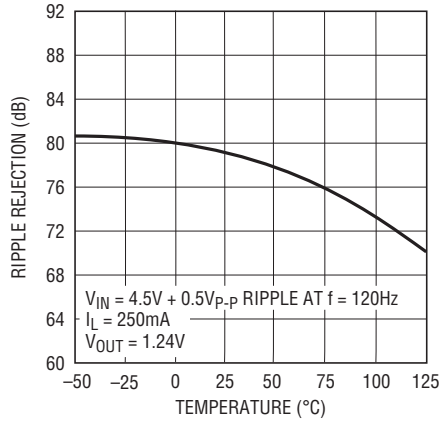

Input Ripple Rejection

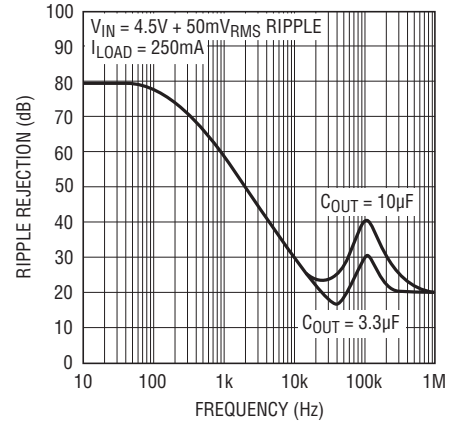

Minimum Input Voltage

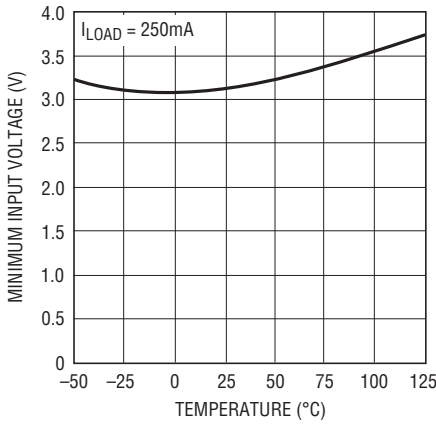

Load Regulation

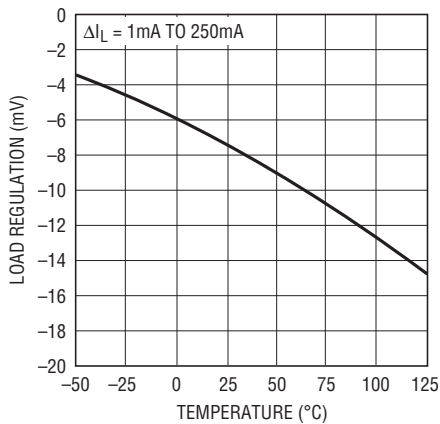

Output Noise Spectral Density

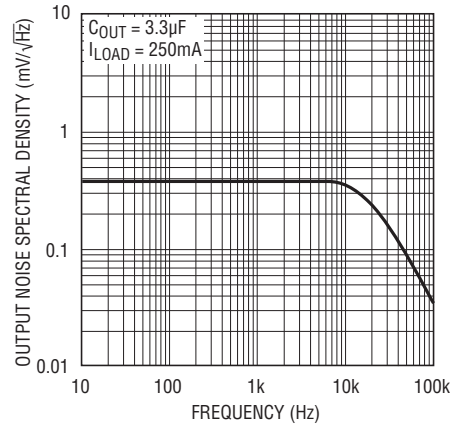

10Hz to 100Hz Output Noise

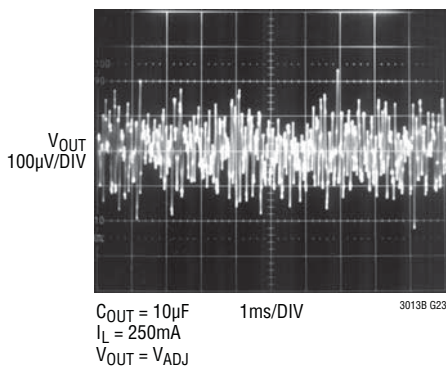

Transition Response

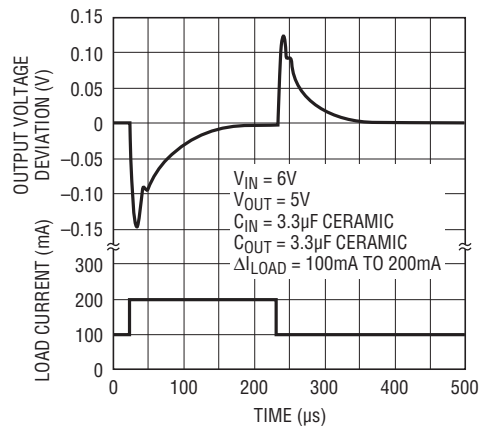

PIN FUNCTIONS (DFN/TSSOP)

NC (Pins 1, 8, 9, 12/Pins 2, 11, 12, 15): No Connect. No Connect pins may be floated, tied to IN or tied to GND.

OUT (Pins 2, 3/Pins 3, 4): Output. The output supplies power to the load. A minimum output capacitor of $3.3\mu\text{F}$ is required to prevent oscillations. Larger output capacitors will be required for applications with large transient loads to limit peak voltage transients. See the Applications Information section for more information on output capacitance and reverse output characteristics.

ADJ (Pin 4/Pin 5): Adjust. This is the input to the error amplifier. This pin is internally clamped to $\pm 7\text{V}$. It has a bias current of 30nA which flows into the pin (see curve of ADJ Pin Bias Current vs Temperature in the Typical Performance Characteristics). The ADJ pin voltage is 1.24V referenced to ground, and the output voltage range is 1.24V to 60V .

GND (Pin 5/Pins 1, 6, 8, 9, 16): Ground.

PWRGD (Pin 6/Pin 7): Power Good. The PWRGD flag is an open-collector flag to indicate that the output voltage has come up to above 90% of the nominal output voltage. There is no internal pull-up on this pin; a pull-up resistor must be used. The PWRGD pin will change state from an open-collector to high impedance after both the output is above 90% of the nominal voltage and the capacitor on the C_T pin has charged through a 1V differential. The maximum pull-down current of the PWRGD pin in the low state is $50\mu\text{A}$.

C_T (Pin 7/Pin 10): Timing Capacitor. The C_T pin allows the use of a small capacitor to delay the timing between the point where the output crosses the PWRGD threshold and the PWRGD flag changes to a high impedance state. Current out of this pin during the charging phase is $3\mu\text{A}$. The voltage difference between the PWRGD low and PWRGD high states is 1.6V (see the Applications Information Section).

IN (Pins 10, 11/Pins 13,14): Input. Power is supplied to the device through the IN pin. A bypass capacitor is required on this pin if the device is more than six inches away from the main input filter capacitor. In general, the output impedance of a battery rises with frequency, so it is advisable to include a bypass capacitor in battery-powered circuits. A bypass capacitor in the range of $1\mu\text{F}$ to $10\mu\text{F}$ is sufficient. The LT3013B is designed to withstand reverse voltages on the IN pin with respect to ground and the OUT pin. In the case of a reversed input, which can happen if a battery is plugged in backwards, the LT3013B will act as if there is a diode in series with its input. There will be no reverse current flow into the LT3013B and no reverse voltage will appear at the load. The device will protect both itself and the load.

Exposed Pad (Pin 13/Pin 17): Ground. The exposed backside of the package is an electrical connection for GND. As such, to ensure optimum device operation and thermal performance, the Exposed Pad must be connected directly to Pin 5/Pin 6 on the PC board.

APPLICATIONS INFORMATION

The LT3013B is a 250mA high voltage low dropout regulator with micropower quiescent current. The device is capable of supplying 250mA at a dropout voltage of 400mV. Operating quiescent current is only 65µA. In addition to the low quiescent current, the LT3013B incorporates several protection features which make it ideal for use in battery-powered systems. The device is protected against both reverse input and reverse output voltages. In battery backup applications where the output can be held up by a backup battery when the input is pulled to ground, the LT3013B acts like it has a diode in series with its output and prevents reverse current flow.

Adjustable Operation

The LT3013B has an output voltage range of 1.24V to 60V. The output voltage is set by the ratio of two external resistors as shown in Figure 1. The device servos the output to maintain the voltage at the adjust pin at 1.24V referenced to ground. The current in R1 is then equal to $1.24V/R1$ and the current in R2 is the current in R1 plus the ADJ pin bias current. The ADJ pin bias current, 30nA at 25°C, flows through R2 into the ADJ pin. The output voltage can be calculated using the formula in Figure 1. The value of R1 should be less than 250k to minimize errors in the output voltage caused by the ADJ pin bias current.

The adjustable device is tested and specified with the ADJ pin tied to the OUT pin and a 5µA DC load (unless otherwise specified) for an output voltage of 1.24V. Specifications for

output voltages greater than 1.24V will be proportional to the ratio of the desired output voltage to 1.24V; ($V_{OUT}/1.24V$). For example, load regulation for an output current change of 1mA to 250mA is -7mV typical at $V_{OUT} = 1.24V$. At $V_{OUT} = 12V$, load regulation is:

$$(12V/1.24V) \cdot (-7mV) = -68mV$$

Output Capacitance and Transient Response

The LT3013B is designed to be stable with a wide range of output capacitors. The ESR of the output capacitor affects stability, most notably with small capacitors. A minimum output capacitor of 3.3µF with an ESR of 3Ω or less is recommended to prevent oscillations. The LT3013B is a micropower device and output transient response will be a function of output capacitance. Larger values of output capacitance decrease the peak deviations and provide improved transient response for larger load current changes. Bypass capacitors, used to decouple individual components powered by the LT3013B, will increase the effective output capacitor value.

Extra consideration must be given to the use of ceramic capacitors. Ceramic capacitors are manufactured with a variety of dielectrics, each with different behavior across temperature and applied voltage. The most common dielectrics used are specified with EIA temperature characteristic codes of Z5U, Y5V, X5R and X7R. The Z5U and Y5V dielectrics are good for providing high capacitances in a small package, but they tend to have strong voltage

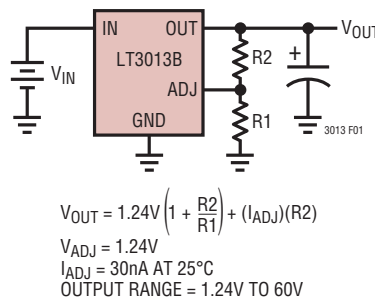

Figure 1. Adjustable Operation

APPLICATIONS INFORMATION

and temperature coefficients as shown in Figures 2 and 3. When used with a 5V regulator, a 16V 10μF Y5V capacitor can exhibit an effective value as low as 1μF to 2μF for the DC bias voltage applied and over the operating temperature range. The X5R and X7R dielectrics result in more stable characteristics and are more suitable for use as the output capacitor. The X7R type has better stability across temperature, while the X5R is less expensive and is available in higher values. Care still must be exercised when using X5R and X7R capacitors; the X5R and X7R codes

only specify operating temperature range and maximum capacitance change over temperature. Capacitance change due to DC bias with X5R and X7R capacitors is better than Y5V and Z5U capacitors, but can still be significant enough to drop capacitor values below appropriate levels. Capacitor DC bias characteristics tend to improve as component case size increases, but expected capacitance at operating voltage should be verified.

Voltage and temperature coefficients are not the only sources of problems. Some ceramic capacitors have a piezoelectric response. A piezoelectric device generates voltage across its terminals due to mechanical stress, similar to the way a piezoelectric accelerometer or microphone works. For a ceramic capacitor the stress can be induced by vibrations in the system or thermal transients.

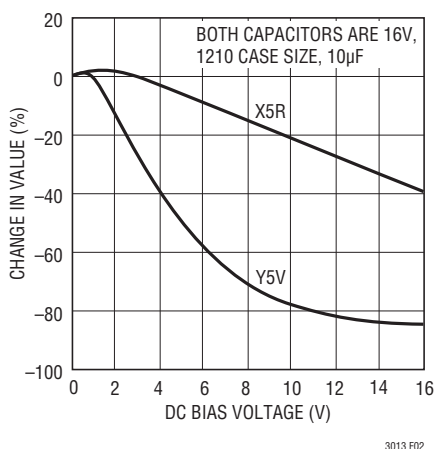

Figure 2. Ceramic Capacitor DC Bias Characteristics

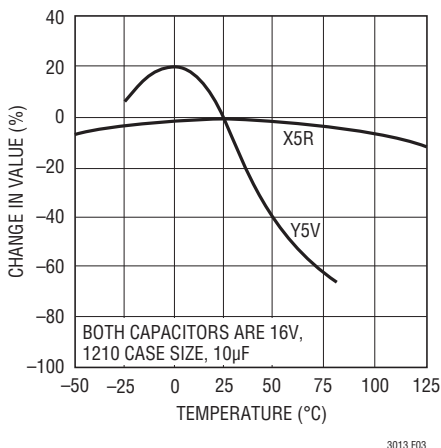

Figure 3. Ceramic Capacitor Temperature Characteristics

PWRGD Flag and Timing Capacitor Delay

The PWRGD flag is used to indicate that the ADJ pin voltage is within 10% of the regulated voltage. The PWRGD pin is an open-collector output, capable of sinking 50μA of current when the ADJ pin voltage is low. There is no internal pull-up on the PWRGD pin; an external pull-up resistor must be used. When the ADJ pin rises to within 10% of its final reference value, a delay timer is started. At the end of this delay, programmed by the value of the capacitor on the C_T pin, the PWRGD pin switches to a high impedance and is pulled up to a logic level by an external pull-up resistor.

To calculate the capacitor value on the C_T pin, use the following formula:

$$C_{\text{TIME}} = \frac{I_{\text{CT}} \cdot t_{\text{DELAY}}}{V_{\text{CT(HIGH)}} - V_{\text{CT(LOW)}}$$

Figure 4 shows a block diagram of the PWRGD circuit. At start-up, the timing capacitor is discharged and the PWRGD pin will be held low. As the output voltage increases and the ADJ pin crosses the 90% threshold, the JK flip-flop is reset, and the 3μA current source begins to charge the

APPLICATIONS INFORMATION

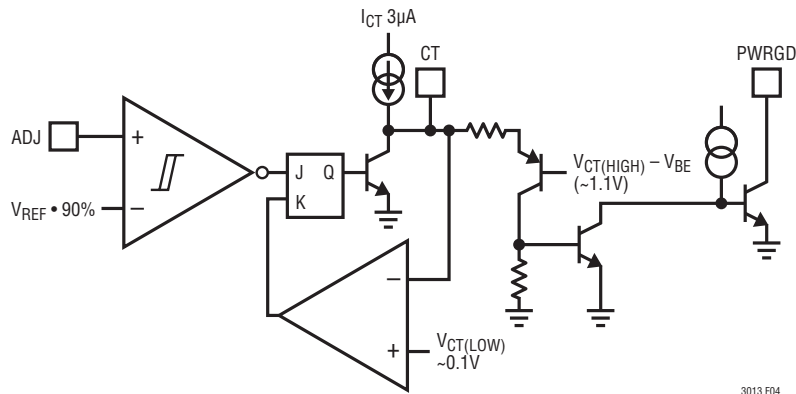

Figure 4. PWRGD Circuit Block Diagram

timing capacitor. Once the voltage on the C_T pin reaches the $V_{CT(HIGH)}$ threshold (approximately 1.7V at 25°C), the capacitor voltage is clamped and the PWRGD pin is set to a high impedance state.

During normal operation, an internal glitch filter will ignore short transients (<15µs). Longer transients below the 90% threshold will reset the JK flip-flop. This flip-flop ensures that the capacitor on the C_T pin is quickly discharged all the way to the $V_{CT(LOW)}$ threshold before restarting the time delay. This provides a consistent time delay after the ADJ pin is within 10% of the regulated voltage before the PWRGD pin switches to high impedance.

Current Limit and Safe Operating Area Protection

Like many IC power regulators, the LT3013B has safe operating area protection. The safe operating area protection decreases the current limit as the input voltage increases and keeps the power transistor in a safe operating region. The protection is designed to provide some output current at all values of input voltage up to the device breakdown (see curve of Current Limit vs Input Voltage in the Typical Performance Characteristics).

The LT3013B is limited for operating conditions by maximum junction temperature. While operating at maximum input voltage, the output current range must be limited; when operating at maximum output current, the input voltage range must be limited. Device specifications will

not apply for all possible combinations of input voltage and output current. Operating the LT3013B beyond the maximum junction temperature rating may impair the life of the device.

Thermal Considerations

The power handling capability of the device will be limited by the maximum rated junction temperature (125°C). The power dissipated by the device will be made up of two components:

1. Output current multiplied by the input/output voltage differential: $I_{OUT} \cdot (V_{IN} - V_{OUT})$ and,
2. GND pin current multiplied by the input voltage: $I_{GND} \cdot V_{IN}$.

The GND pin current can be found by examining the GND Pin Current curves in the Typical Performance Characteristics. Power dissipation will be equal to the sum of the two components listed above.

The LT3013B series regulators have internal thermal limiting designed to protect the device during overload conditions. For continuous normal conditions the maximum junction temperature rating of 125°C must not be exceeded. It is important to give careful consideration to all sources of thermal resistance from junction to ambient. Additional heat sources mounted nearby must also be considered.

APPLICATIONS INFORMATION

For surface mount devices, heat sinking is accomplished by using the heat spreading capabilities of the PC board and its copper traces. Copper board stiffeners and plated through-holes can also be used to spread the heat generated by power devices.

The following tables list thermal resistance for several different board sizes and copper areas. All measurements were taken in still air on 3/32" FR-4 board with one ounce copper.

Table 1. Measured Thermal Resistance (TSSOP)

COPPER AREA		BOARD AREA	THERMAL RESISTANCE (JUNCTION-TO-AMBIENT)
TOPSIDE	BACKSIDE		
2500 sq mm	2500 sq mm	2500 sq mm	40°C/W
1000 sq mm	2500 sq mm	2500 sq mm	45°C/W
225 sq mm	2500 sq mm	2500 sq mm	50°C/W
100 sq mm	2500 sq mm	2500 sq mm	62°C/W

Table 2. Measured Thermal Resistance (DFN)

COPPER AREA		BOARD AREA	THERMAL RESISTANCE (JUNCTION-TO-AMBIENT)
TOPSIDE	BACKSIDE		
2500 sq mm	2500 sq mm	2500 sq mm	40°C/W
1000 sq mm	2500 sq mm	2500 sq mm	45°C/W
225 sq mm	2500 sq mm	2500 sq mm	50°C/W
100 sq mm	2500 sq mm	2500 sq mm	62°C/W

The thermal resistance junction-to-case (θ_{JC}), measured at the Exposed Pad on the back of the die, is 16°C/W.

Continuous operation at large input/output voltage differentials and maximum load current is not practical due to thermal limitations. Transient operation at high input/output differentials is possible. The approximate thermal time constant for a 2500sq mm 3/32" FR-4 board with maximum topside and backside area for one ounce copper is 3 seconds. This time constant will increase as more thermal mass is added (i.e., vias, larger board, and other components).

For an application with transient high power peaks, average power dissipation can be used for junction temperature calculations as long as the pulse period is significantly less than the thermal time constant of the device and board.

Calculating Junction Temperature

Example 1: Given an output voltage of 5V, an input voltage range of 8V to 12V, an output current range of 0mA to 250mA, and a maximum ambient temperature of 30°C, what will the maximum junction temperature be?

The power dissipated by the device will be equal to:

$$I_{OUT(MAX)} \cdot (V_{IN(MAX)} - V_{OUT}) + (I_{GND} \cdot V_{IN(MAX)})$$

where:

$$I_{OUT(MAX)} = 250mA$$

$$V_{IN(MAX)} = 12V$$

$$I_{GND} \text{ at } (I_{OUT} = 250mA, V_{IN} = 12V) = 8mA$$

So:

$$P = 250mA \cdot (12V - 5V) + (8mA \cdot 12V) = 1.85W$$

The thermal resistance will be in the range of 40°C/W to 62°C/W depending on the copper area. So the junction temperature rise above ambient will be approximately equal to:

$$1.85W \cdot 50°C/W = 92.3°C$$

The maximum junction temperature will then be equal to the maximum junction temperature rise above ambient plus the maximum ambient temperature or:

$$T_{JMAX} = 30°C + 92.3°C = 122.3°C$$

Example 2: Given an output voltage of 5V, an input voltage of 48V that rises to 72V for 5ms(max) out of every 100ms, and a 5mA load that steps to 200mA for 50ms out of every 250ms, what is the junction temperature rise above ambient? Using a 500ms period (well under the time constant of the board), power dissipation is as follows:

$$P1(48V \text{ in, } 5mA \text{ load}) = 5mA \cdot (48V - 5V) + (200\mu A \cdot 48V) = 0.23W$$

$$P2(48V \text{ in, } 50mA \text{ load}) = 200mA \cdot (48V - 5V) + (8mA \cdot 48V) = 8.98W$$

$$P3(72V \text{ in, } 5mA \text{ load}) = 5mA \cdot (72V - 5V) + (200\mu A \cdot 72V) = 0.35W$$

$$P4(72V \text{ in, } 50mA \text{ load}) = 200mA \cdot (72V - 5V) + (8mA \cdot 72V) = 13.98W$$

APPLICATIONS INFORMATION

Operation at the different power levels is as follows:

76% operation at P1, 19% for P2, 4% for P3, and 1% for P4.

$$PEFF = 76\%(0.23W) + 19\%(8.98W) + 4\%(0.35W) + 1\%(13.98W) = 2.03W$$

With a thermal resistance in the range of 40°C/W to 62°C/W, this translates to a junction temperature rise above ambient of 81°C to 125°C.

Protection Features

The LT3013B incorporates several protection features which make it ideal for use in battery-powered circuits. In addition to the normal protection features associated with monolithic regulators, such as current limiting and thermal limiting, the device is protected against reverse-input voltages, and reverse voltages from output to input.

Current limit protection and thermal overload protection are intended to protect the device against current overload conditions at the output of the device. For normal operation, the junction temperature should not exceed 125°C.

Like many IC power regulators, the LT3013B has safe operating area protection. The safe area protection decreases the current limit as input voltage increases and keeps the power transistor inside a safe operating region for all values of input voltage. The protection is designed to provide some output current at all values of input voltage up to the device breakdown. The SOA protection circuitry for the LT3013B uses a current generated when the input voltage exceeds 25V to decrease current limit. This current shows up as additional quiescent current for input voltages above 25V. This increase in quiescent current occurs both in normal operation and in shutdown (see curve of Quiescent Current in the Typical Performance Characteristics).

The input of the device will withstand reverse voltages of 80V. No negative voltage will appear at the output. The device will protect both itself and the load. This provides protection against batteries which can be plugged in backward.

The ADJ pin of the device can be pulled above or below ground by as much as 7V without damaging the device.

If the input is left open circuit or grounded, the ADJ pin will act like an open circuit when pulled below ground, and like a large resistor (typically 100k) in series with a diode when pulled above ground. If the input is powered by a voltage source, pulling the ADJ pin below the reference voltage will cause the device to try and force the current limit current out of the output. This will cause the output to go to a unregulated high voltage. Pulling the ADJ pin above the reference voltage will turn off all output current.

In situations where the ADJ pin is connected to a resistor divider that would pull the ADJ pin above its 7V clamp voltage if the output is pulled high, the ADJ pin input current must be limited to less than 5mA. For example, a resistor divider is used to provide a regulated 1.5V output from the 1.24V reference when the output is forced to 60V. The top resistor of the resistor divider must be chosen to limit the current into the ADJ pin to less than 5mA when the ADJ pin is at 7V. The 53V difference between the OUT and ADJ pins divided by the 5mA maximum current into the ADJ pin yields a minimum top resistor value of 10.6k.

In circuits where a backup battery is required, several different input/output conditions can occur. The output voltage may be held up while the input is either pulled to ground, pulled to some intermediate voltage, or is left open circuit. Current flow back into the output will follow the curve shown in Figure 5. The rise in reverse output current above 7V occurs from the breakdown of the 7V clamp on the ADJ pin. With a resistor divider on the

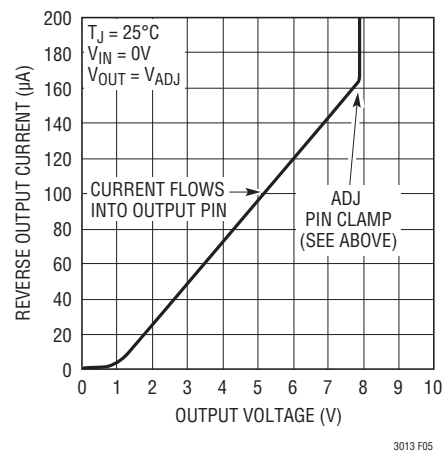

Figure 5. Reverse Output Current

APPLICATIONS INFORMATION

regulator output, this current will be reduced depending on the size of the resistor divider.

When the IN pin of the LT3013B is forced below the OUT pin or the OUT pin is pulled above the IN pin, input

current will typically drop to less than 2µA. This can happen if the input of the LT3013B is connected to a discharged (low voltage) battery and the output is held up by either a backup battery or a second regulator circuit.

TYPICAL APPLICATIONS

LT3013B Automotive Application

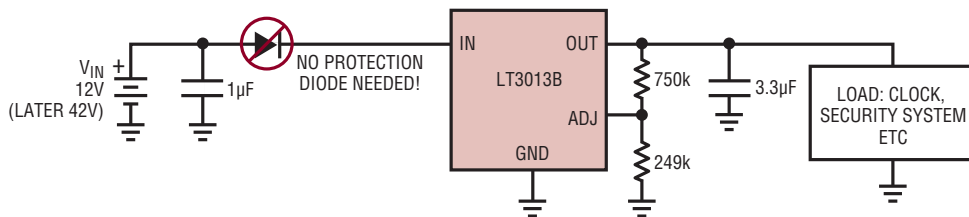

LT3013B Telecom Application

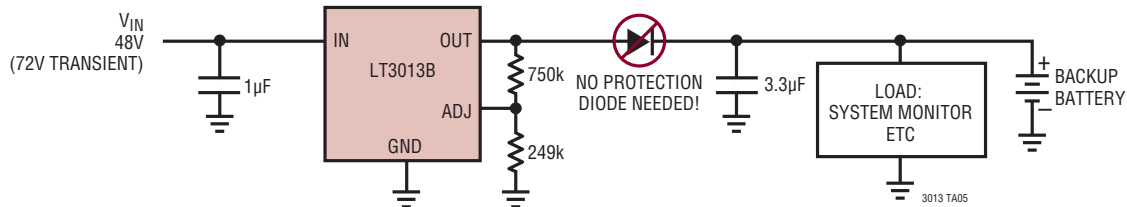

Constant Brightness for Indicator LED over Wide Input Voltage Range

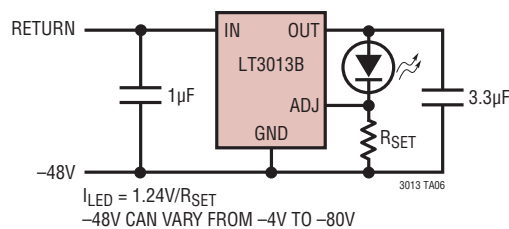

PACKAGE DESCRIPTION

DE Package
12-Lead Plastic DFN (4mm × 3mm)
 (Reference LTC DWG # 05-08-1695 Rev D)

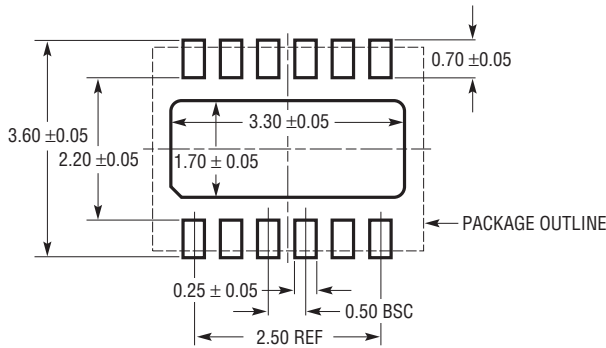

RECOMMENDED SOLDER PAD PITCH AND DIMENSIONS
 APPLY SOLDER MASK TO AREAS THAT ARE NOT SOLDERED

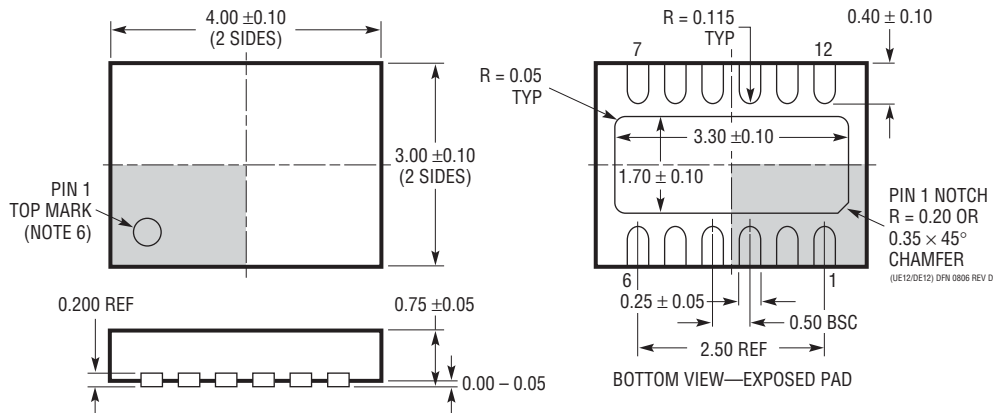

- NOTE:
1. DRAWING PROPOSED TO BE A VARIATION OF VERSION (WGED) IN JEDEC PACKAGE OUTLINE M0-229
 2. DRAWING NOT TO SCALE
 3. ALL DIMENSIONS ARE IN MILLIMETERS
 4. DIMENSIONS OF EXPOSED PAD ON BOTTOM OF PACKAGE DO NOT INCLUDE MOLD FLASH. MOLD FLASH, IF PRESENT, SHALL NOT EXCEED 0.15mm ON ANY SIDE
 5. EXPOSED PAD SHALL BE SOLDER PLATED
 6. SHADED AREA IS ONLY A REFERENCE FOR PIN 1 LOCATION ON THE TOP AND BOTTOM OF PACKAGE

PACKAGE DESCRIPTION

FE Package
16-Lead Plastic TSSOP (4.4mm)
 (Reference LTC DWG # 05-08-1663)
Exposed Pad Variation BB

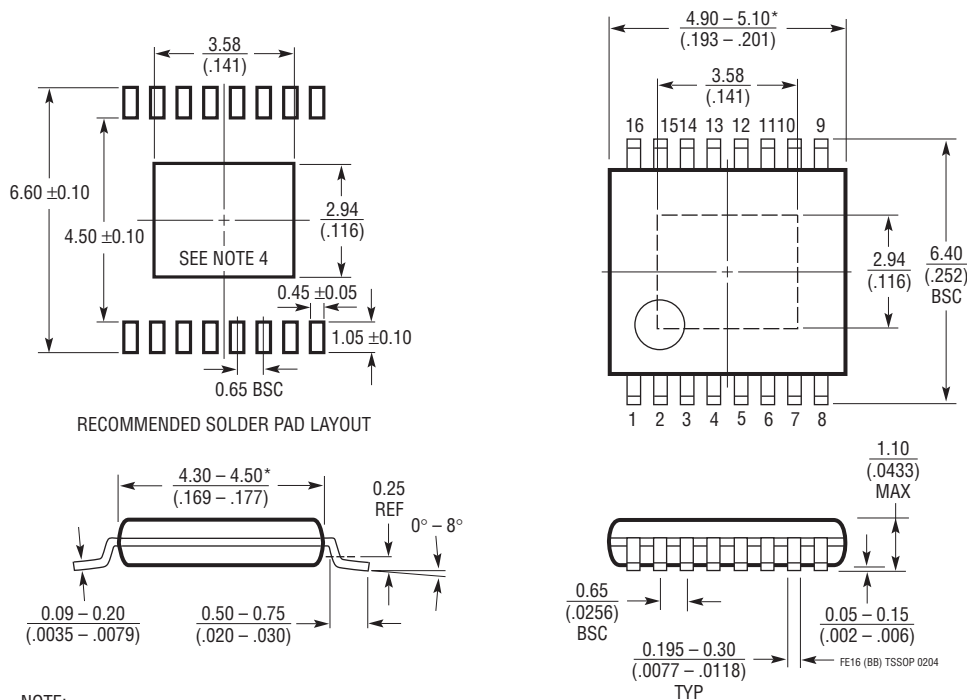

- NOTE:
1. CONTROLLING DIMENSION: MILLIMETERS
 2. DIMENSIONS ARE IN $\frac{\text{MILLIMETERS}}{\text{INCHES}}$
 3. DRAWING NOT TO SCALE
 4. RECOMMENDED MINIMUM PCB METAL SIZE FOR EXPOSED PAD ATTACHMENT
- *DIMENSIONS DO NOT INCLUDE MOLD FLASH. MOLD FLASH SHALL NOT EXCEED 0.150mm (.006") PER SIDE

LT3013B

RELATED PARTS

PART NUMBER	DESCRIPTION	COMMENTS
LT1020	125mA, Micropower Regulator and Comparator	V_{IN} : 4.5V to 36V, V_{OUT} = 2.5V, V_{DO} = 0.4V, I_Q = 40 μ A, I_{SD} = 40 μ A, Comparator and Reference, Class B Outputs, S16, PDIP14 Packages
LT1120/LT1120A	125mA, Micropower Regulator and Comparator	V_{IN} : 4.5V to 36V, V_{OUT} = 2.5V, V_{DO} = 0.4V, I_Q = 40 μ A, I_{SD} = 10 μ A, Comparator and Reference, Logic Shutdown, Ref Sources and Sinks 2/4mA, S8, N8 Packages
LT1121/LT1121HV	150mA, Micropower, LDO	V_{IN} : 4.2V to 30/36V, V_{OUT} = 3.75V, V_{DO} = 0.42V, I_Q = 30 μ A, I_{SD} = 16 μ A, Reverse Battery Protection, SOT-223, S8, Z Packages
LT1129	700mA, Micropower, LDO	V_{IN} : 4.2V to 30V, V_{OUT} = 3.75V, V_{DO} = 0.4V, I_Q = 50 μ A, I_{SD} = 16 μ A, DD, SOT-223, S8, TO220-5, TSSOP20 Packages
LT1616	25V, 500mA (I_{OUT}), 1.4MHz, High Efficiency Step-Down DC/DC Converter	V_{IN} : 3.6V to 25V, V_{OUT} = 1.25V, I_Q = 1.9mA, I_{SD} = <1 μ A, ThinSOT Package
LT1676	60V, 440mA (I_{OUT}), 100kHz, High Efficiency Step-Down DC/DC Converter	V_{IN} : 7.4V to 60V, V_{OUT} = 1.24V, I_Q = 3.2mA, I_{SD} = 2.5 μ A, S8 Package
LT1761	100mA, Low Noise Micropower, LDO	V_{IN} : 1.8V to 20V, V_{OUT} = 1.22V, V_{DO} = 0.3V, I_Q = 20 μ A, I_{SD} = <1 μ A, Low Noise < 20 μ V _{RMS} P-P, Stable with 1 μ F Ceramic Capacitors, ThinSOT Package
LT1762	150mA, Low Noise Micropower, LDO	V_{IN} : 1.8V to 20V, V_{OUT} = 1.22V, V_{DO} = 0.3V, I_Q = 25 μ A, I_{SD} = <1 μ A, Low Noise < 20 μ V _{RMS} P-P, MS8 Package
LT1763	500mA, Low Noise Micropower, LDO	V_{IN} : 1.8V to 20V, V_{OUT} = 1.22V, V_{DO} = 0.3V, I_Q = 30 μ A, I_{SD} = <1 μ A, Low Noise < 20 μ V _{RMS} P-P, S8 Package
LT1764/LT1764A	3A, Low Noise, Fast Transient Response, LDO	V_{IN} : 2.7V to 20V, V_{OUT} = 1.21V, V_{DO} = 0.34V, I_Q = 1mA, I_{SD} = <1 μ A, Low Noise < 40 μ V _{RMS} P-P, "A" Version Stable with Ceramic Capacitors, DD, TO220-5 Packages
LT1766	60V, 1.2A (I_{OUT}), 200kHz, High Efficiency Step-Down DC/DC Converter	V_{IN} : 5.5V to 60V, V_{OUT} = 1.20V, I_Q = 2.5mA, I_{SD} = 25 μ A, TSSOP16/E Package
LT1776	40V, 550mA (I_{OUT}), 200kHz, High Efficiency Step-Down DC/DC Converter	V_{IN} : 7.4V to 40V, V_{OUT} = 1.24V, I_Q = 3.2mA, I_{SD} = 30 μ A, N8, S8 Packages
LT1934/LT1934-1	300mA/60mA, (I_{OUT}), Constant Off-Time, High Efficiency Step-Down DC/DC Converter	90% Efficiency, V_{IN} : 3.2V to 34V, V_{OUT} = 1.25V, I_Q = 14 μ A, I_{SD} = <1 μ A, ThinSOT Package
LT1956	60V, 1.2A (I_{OUT}), 500kHz, High Efficiency Step-Down DC/DC Converter	V_{IN} : 5.5V to 60V, V_{OUT} = 1.20V, I_Q = 2.5mA, I_{SD} = 25 μ A, TSSOP16/E Package
LT1962	300mA, Low Noise Micropower, LDO	V_{IN} : 1.8V to 20V, V_{OUT} = 1.22V, V_{DO} = 0.27V, I_Q = 30 μ A, I_{SD} = <1 μ A, Low Noise < 20 μ V _{RMS} P-P, MS8 Package
LT1963/LT1963A	1.5A, Low Noise, Fast Transient Response, LDO	V_{IN} : 2.1V to 20V, V_{OUT} = 1.21V, V_{DO} = 0.34V, I_Q = 1mA, I_{SD} = <1 μ A, Low Noise < 40 μ V _{RMS} P-P, "A" Version Stable with Ceramic Capacitors, DD, TO220-5, SOT-223, S8 Packages
LT1964	200mA, Low Noise Micropower, Negative LDO	V_{IN} : -1.9V to -20V, V_{OUT} = -1.21V, V_{DO} = 0.34V, I_Q = 30 μ A, I_{SD} = 3 μ A, Low Noise < 30 μ V _{RMS} P-P, Stable with Ceramic Capacitors, ThinSOT Package
LT3010	50mA, High Voltage, Micropower LDO	V_{IN} : 3V to 80V, $V_{OUT(MIN)}$ = 1.2V, V_{DO} = 0.3V, I_Q = 30 μ A, I_{SD} < 1 μ A, Low Noise: <100 μ V _{RMS} , Stable with 1 μ F Output Capacitor, Exposed MS8E Package