

FMG2G300LS60E

Molding Type Module

General Description

Fairchild IGBT Power Module provides low conduction as well as short circuit ruggedness. It's designed for the applications such as welder.

Features

- Short Circuit Rated Time; 10us @ $T_C = 100^\circ\text{C}$, $V_{GE} = 15\text{V}$
- Low Saturation Voltage: $V_{CE(\text{sat})} = 1.4\text{V}$ @ $I_C = 300\text{A}$
- High Input Impedance
- Fast & Soft Anti-Parallel FWD
- UL Certified No.E209204

Application

- AC/ DC Welder

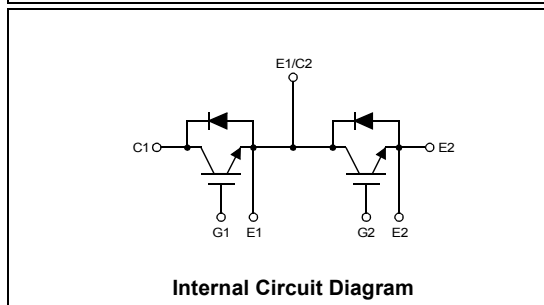
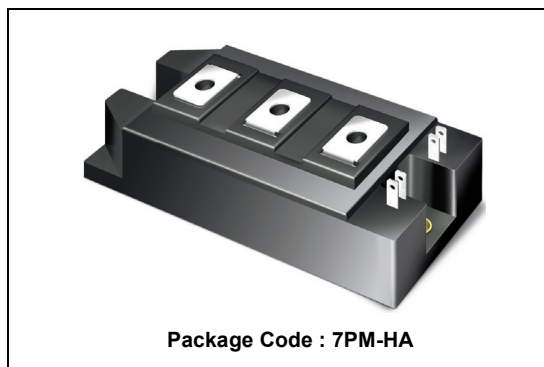

Absolute Maximum Ratings $T_C = 25^\circ\text{C}$ unless otherwise noted

Symbol	Description	FMG2G300LS60E	Units
V_{CES}	Collector-Emitter Voltage	600	V
V_{GES}	Gate-Emitter Voltage	± 20	V
I_C	Collector Current	300	A
$I_{CM(1)}$	Pulsed Collector Current	600	A
I_F	Diode Continuous Forward Current	300	A
I_{FM}	Diode Maximum Forward Current	600	A
P_D	Maximum Power Dissipation	892	W
T_{SC}	Short Circuit Withstand Time	10	us
T_J	Operating Junction Temperature	-40 to +150	$^\circ\text{C}$
T_{STG}	Storage Temperature Range	-40 to +125	$^\circ\text{C}$
V_{ISO}	Isolation Voltage	2500	V
Mounting Torque	Power Terminal Screw : M5	4.0	N.m
	Mounting Screw : M6	4.0	N.m

Notes :

(1) Repetitive rating : Pulse width limited by max. junction temperature

Electrical Characteristics of IGBT T_C = 25°C unless otherwise noted

Symbol	Parameter	Test Conditions	Min.	Typ.	Max.	Units
Off Characteristics						
BV _{CES}	Collector-Emitter Breakdown Voltage	V _{GE} = 0V, I _C = 250uA	600	--	--	V
ΔBV _{CES} /ΔT _J	Temperature Coeff. of Breakdown Voltage	V _{GE} = 0V, I _C = 1mA	--	0.6	--	V/°C
I _{CES}	Collector Cut-Off Current	V _{CE} = V _{CES} , V _{GE} = 0V	--	--	250	uA
I _{GES}	Gate - Emitter Leakage Current	V _{GE} = V _{GES} , V _{CE} = 0V	--	--	± 100	nA

On Characteristics

V _{GE(th)}	Gate - Emitter Threshold Voltage	I _C = 300mA, V _{CE} = V _{GE}	5.0	6.5	8.5	V
V _{CE(sat)}	Collector to Emitter Saturation Voltage	I _C = 300A, V _{GE} = 15V	--	1.4	1.8	V

Switching Characteristics

t _{d(on)}	Turn-On Delay Time	V _{CC} = 300 V, I _C = 300A, R _G = 10Ω, V _{GE} = 15V, Inductive Load, T _C = 25°C	--	0.23	--	us
t _r	Rise Time		--	0.21	--	us
t _{d(off)}	Turn-Off Delay Time		--	0.43	--	us
t _f	Fall Time		--	2.43	--	us
E _{on}	Turn-On Switching Loss		--	13	--	mJ
E _{off}	Turn-Off Switching Loss	--	180	--	mJ	
t _{d(on)}	Turn-On Delay Time	V _{CC} = 300 V, I _C = 300A, R _G = 10Ω, V _{GE} = 15V, Inductive Load, T _C = 125°C	--	0.3	--	us
t _r	Rise Time		--	0.23	--	us
t _{d(off)}	Turn-Off Delay Time		--	0.46	--	us
t _f	Fall Time		--	4.1	--	us
E _{on}	Turn-On Switching Loss		--	15	--	mJ
E _{off}	Turn-Off Switching Loss	--	260	--	mJ	
T _{sc}	Short Circuit Withstand Time	V _{CC} = 300 V, V _{GE} = 15V @ T _C = 100°C	10	--	--	us
Q _g	Total Gate Charge	V _{CE} = 300 V, I _C = 300A, V _{GE} = 15V	--	990	--	nC
Q _{ge}	Gate-Emitter Charge		--	210	--	nC
Q _{gc}	Gate-Collector Charge		--	350	--	nC

Electrical Characteristics of DIODE T_C = 25°C unless otherwise noted

Symbol	Parameter	Test Conditions	Min.	Typ.	Max.	Units	
V _{FM}	Diode Forward Voltage	I _F = 300A	T _C = 25°C	--	1.9	2.8	V
			T _C = 100°C	--	1.8	--	
t _{rr}	Diode Reverse Recovery Time	I _F = 300A di / dt = 600 A/us	T _C = 25°C	--	90	130	ns
			T _C = 100°C	--	130	--	
I _{rr}	Diode Peak Reverse Recovery Current	I _F = 300A di / dt = 600 A/us	T _C = 25°C	--	32	42	A
			T _C = 100°C	--	63	--	
Q _{rr}	Diode Reverse Recovery Charge	I _F = 300A di / dt = 600 A/us	T _C = 25°C	--	1440	2700	nC
			T _C = 100°C	--	4095	--	

Thermal Characteristics

Symbol	Parameter	Typ.	Max.	Units
R _{θJC}	Junction-to-Case (IGBT Part, per 1/2 Module)	--	0.14	°C/W
R _{θJC}	Junction-to-Case (DIODE Part, per 1/2 Module)	--	0.22	°C/W
R _{θJC}	Case-to-Sink (Conductive grease applied)	0.035	--	°C/W
Weight	Weight of Module	240	--	g

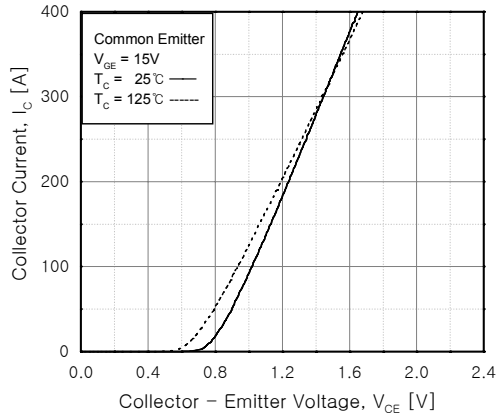

Fig 1. Typical Output Characteristics

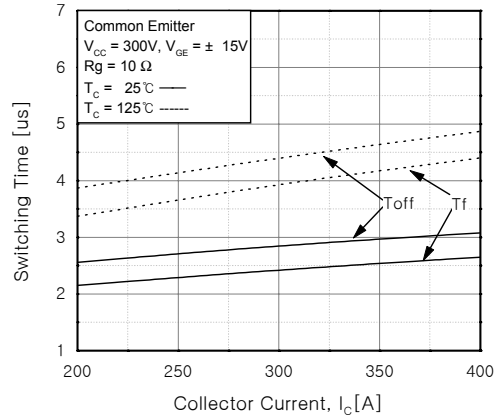

Fig 2. Turn-Off Characteristics vs. Collector Current

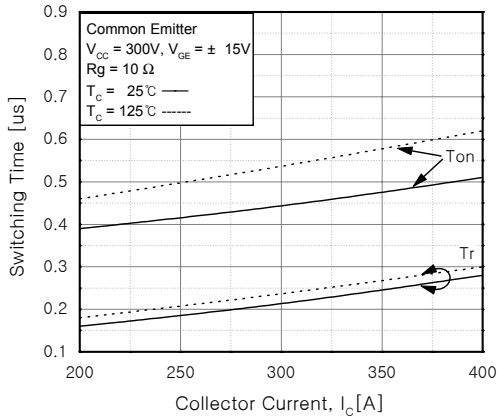

Fig 3. Turn-On Characteristics vs. Collector Current

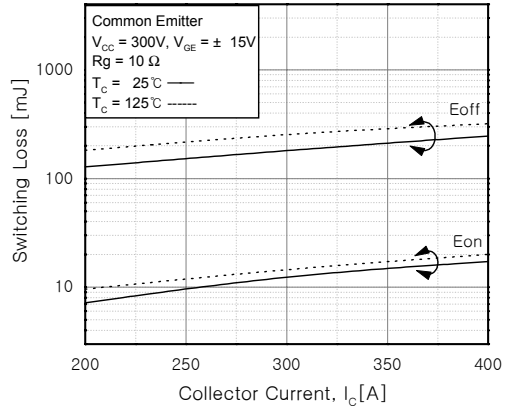

Fig 4. Switching Loss vs. Collector Current

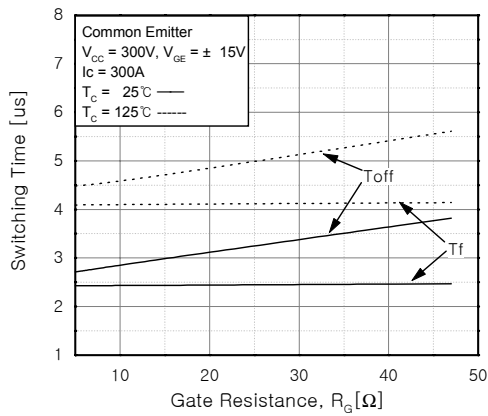

Fig 5. Turn-Off Characteristics vs. Gate Resistance

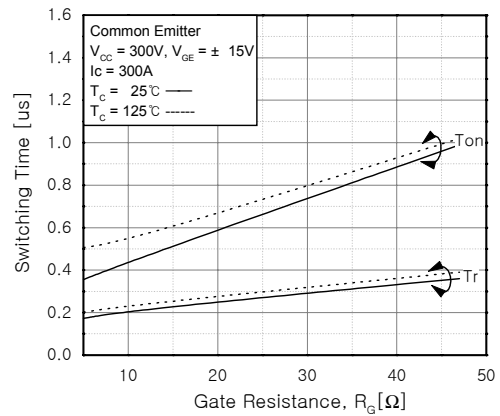

Fig 6. Turn-On Characteristics vs. Gate Resistance

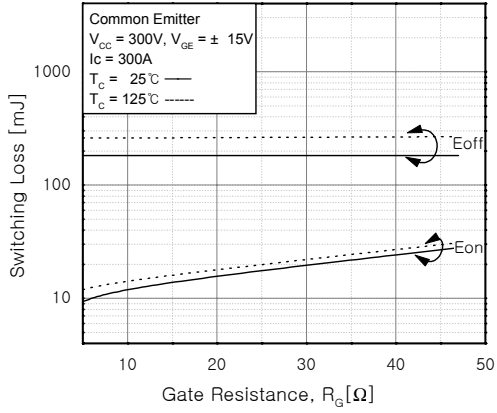

Fig 7. Switching Loss vs. Gate Resistance

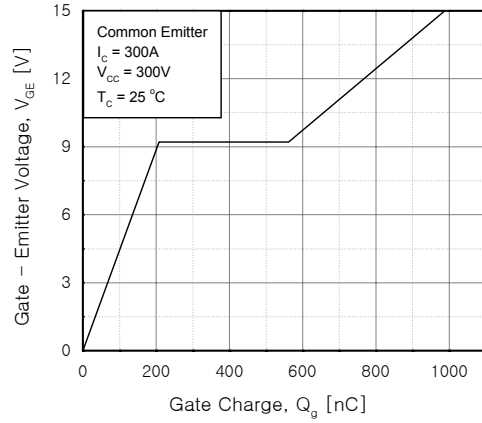

Fig 8. Gate Charge Characteristics

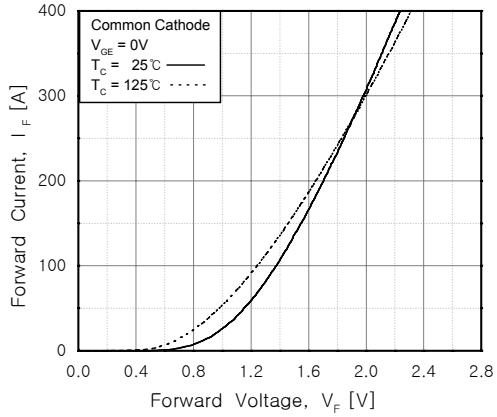

Fig 9. Forward Characteristics (diode)

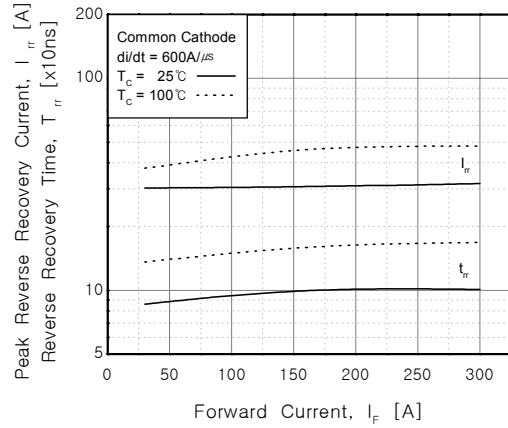
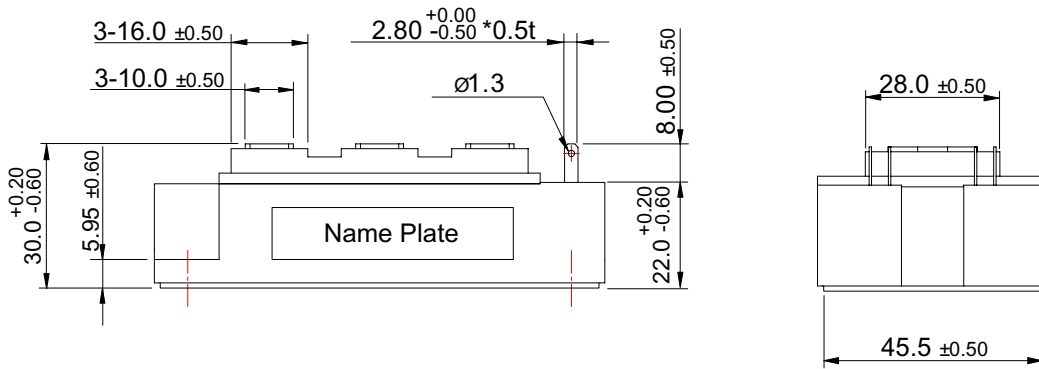
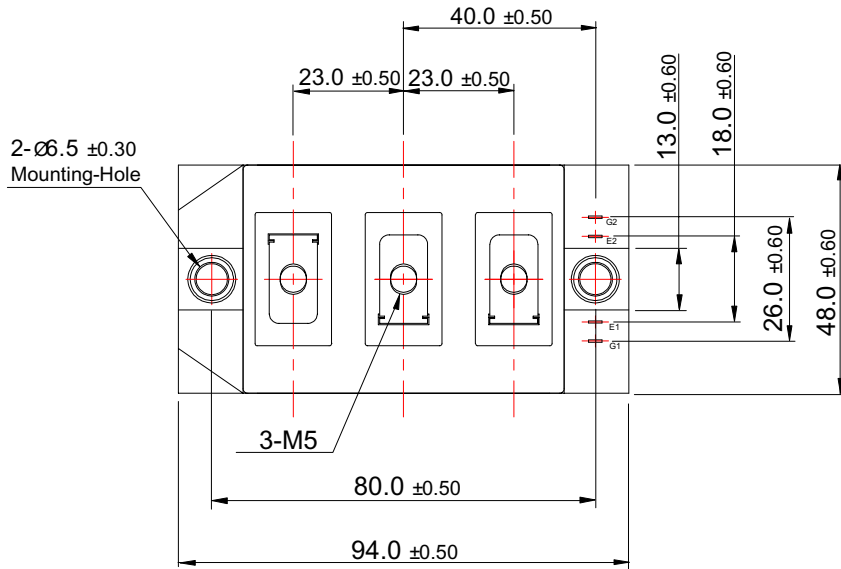

Fig 10. Reverse Recovery Characteristics (diode)

Package Dimension

7PM-HA



FMG2G300LS60E

TRADEMARKS

The following are registered and unregistered trademarks Fairchild Semiconductor owns or is authorized to use and is not intended to be an exhaustive list of all such trademarks.

ACE _x ™	FAST®	ISOPLANAR™	Power247™	SuperFET™
ActiveArray™	FAST _r ™	LittleFET™	PowerSaver™	SuperSOT™-3
Bottomless™	FPS™	MICROCOUPLER™	PowerTrench®	SuperSOT™-6
CoolFET™	FRFET™	MicroFET™	QFET®	SuperSOT™-8
CROSSVOLT™	GlobalOptoisolator™	MicroPak™	QS™	SyncFET™
DOME™	GTO™	MICROWIRE™	QT Optoelectronics™	TinyLogic®
EcoSPARK™	HiSeC™	MSX™	Quiet Series™	TINYOPTO™
E ² CMOS™	I ² C™	MSXPro™	RapidConfigure™	TruTranslation™
EnSigna™	i-Lo™	OCX™	RapidConnect™	UHC™
FACT™	ImpliedDisconnect™	OCXPro™	μSerDes™	UltraFET®
FACT Quiet Series™		OPTOLOGIC®	SILENT SWITCHER®	VCX™
Across the board. Around the world.™		OPTOPLANAR™	SMART START™	
The Power Franchise®		PACMAN™	SPM™	
Programmable Active Droop™		POP™	Stealth™	

DISCLAIMER

FAIRCHILD SEMICONDUCTOR RESERVES THE RIGHT TO MAKE CHANGES WITHOUT FURTHER NOTICE TO ANY PRODUCTS HEREIN TO IMPROVE RELIABILITY, FUNCTION OR DESIGN. FAIRCHILD DOES NOT ASSUME ANY LIABILITY ARISING OUT OF THE APPLICATION OR USE OF ANY PRODUCT OR CIRCUIT DESCRIBED HEREIN; NEITHER DOES IT CONVEY ANY LICENSE UNDER ITS PATENT RIGHTS, NOR THE RIGHTS OF OTHERS.

LIFE SUPPORT POLICY

FAIRCHILD'S PRODUCTS ARE NOT AUTHORIZED FOR USE AS CRITICAL COMPONENTS IN LIFE SUPPORT DEVICES OR SYSTEMS WITHOUT THE EXPRESS WRITTEN APPROVAL OF FAIRCHILD SEMICONDUCTOR CORPORATION.

As used herein:

1. Life support devices or systems are devices or systems which, (a) are intended for surgical implant into the body, or (b) support or sustain life, or (c) whose failure to perform when properly used in accordance with instructions for use provided in the labeling, can be reasonably expected to result in significant injury to the user.
2. A critical component is any component of a life support device or system whose failure to perform can be reasonably expected to cause the failure of the life support device or system, or to affect its safety or effectiveness.

PRODUCT STATUS DEFINITIONS

Definition of Terms

Datasheet Identification	Product Status	Definition
Advance Information	Formative or In Design	This datasheet contains the design specifications for product development. Specifications may change in any manner without notice.
Preliminary	First Production	This datasheet contains preliminary data, and supplementary data will be published at a later date. Fairchild Semiconductor reserves the right to make changes at any time without notice in order to improve design.
No Identification Needed	Full Production	This datasheet contains final specifications. Fairchild Semiconductor reserves the right to make changes at any time without notice in order to improve design.
Obsolete	Not In Production	This datasheet contains specifications on a product that has been discontinued by Fairchild semiconductor. The datasheet is printed for reference information only.