

N-Channel Enhancement Mode

■ Features

- $V_{DS} (V) = 30V$
- $I_D = 5.8 A (V_{GS} = 10V)$
- $R_{DS(ON)} < 28m\Omega (V_{GS} = 10V)$
- $R_{DS(ON)} < 33m\Omega (V_{GS} = 4.5V)$
- $R_{DS(ON)} < 52m\Omega (V_{GS} = 2.5V)$

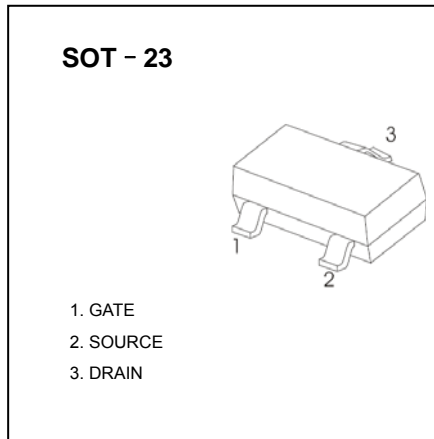
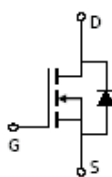

■ Absolute Maximum Ratings  $T_a = 25^\circ C$

Parameter	Symbol	Rating	Unit
Drain-Source Voltage	$V_{DS}$	30	V
Gate-Source Voltage	$V_{GS}$	$\pm 12$	V
Continuous Drain Current $T_A=25^\circ C$ $T_A=70^\circ C$	$I_D$	5.8	A
		4.9	
Pulsed Drain Current *	$I_{DM}$	30	
Power Dissipation $T_A=25^\circ C$ $T_A=70^\circ C$	$P_D$	1.4	W
		1	
Thermal Resistance.Junction- to-Ambient	$R_{thJA}$	125	$^\circ C/W$
Thermal Resistance.Junction- to-Case	$R_{thc}$	60	$^\circ C/W$
Junction and Storage Temperature Range	$T_J, T_{STG}$	-55 to 150	$^\circ C$

\* Repetitive rating, pulse width limited by junction temperature.

**■ Electrical Characteristics Ta = 25°C**

Parameter	Symbol	Testconditions	Min	Typ	Max	Unit
Drain-Source Breakdown Voltage	V <sub>DSS</sub>	I <sub>D</sub> =250 μ A, V <sub>GS</sub> =0V	30			V
Zero Gate Voltage Drain Current	I <sub>DSS</sub>	V <sub>DS</sub> =24V, V <sub>GS</sub> =0V			1	μ A
		V <sub>DS</sub> =24V, V <sub>GS</sub> =0V, T <sub>J</sub> =55°C			5	
Gate-Body leakage current	I <sub>GSS</sub>	V <sub>DS</sub> =0V, V <sub>GS</sub> =±12V			±100	nA
Gate Threshold Voltage	V <sub>GS(th)</sub>	V <sub>DS</sub> =V <sub>GS</sub> I <sub>D</sub> =250 μ A	0.7	1.1	1.4	V
Static Drain-Source On-Resistance	R <sub>DS(on)</sub>	V <sub>GS</sub> =10V, I <sub>D</sub> =5.8A		22.8	28	mΩ
		V <sub>GS</sub> =10V, I <sub>D</sub> =5.8A T <sub>J</sub> =125°C		32	39	
		V <sub>GS</sub> =4.5V, I <sub>D</sub> =5A		27.3	33	mΩ
		V <sub>GS</sub> =2.5V, I <sub>D</sub> =4A		43.3	52	mΩ
On state drain current	I <sub>D(on)</sub>	V <sub>GS</sub> =4.5V, V <sub>DS</sub> =5V	30			A
Forward Transconductance	g <sub>FS</sub>	V <sub>DS</sub> =5V, I <sub>D</sub> =5A	10	15		S
Input Capacitance	C <sub>iss</sub>	V <sub>GS</sub> =0V, V <sub>DS</sub> =15V, f=1MHz		823	1050	pF
Output Capacitance	C <sub>oss</sub>			99		pF
Reverse Transfer Capacitance	C <sub>rss</sub>			77		pF
Gate resistance	R <sub>g</sub>	V <sub>GS</sub> =0V, V <sub>DS</sub> =0V, f=1MHz		1.4	3.6	Ω
Total Gate Charge	Q <sub>g</sub>	V <sub>GS</sub> =4.5V, V <sub>DS</sub> =15V, I <sub>D</sub> =5.8A		9.7	12	nC
Gate Source Charge	Q <sub>gs</sub>			1.6		nC
Gate Drain Charge	Q <sub>gd</sub>			3.1		nC
Turn-On DelayTime	t <sub>D(on)</sub>			3.3	5	ns
Turn-On Rise Time	t <sub>r</sub>	V <sub>GS</sub> =10V, V <sub>DS</sub> =15V, R <sub>L</sub> =2.7 Ω, R <sub>GEN</sub> =3 Ω		4.8	7	ns
Turn-Off DelayTime	t <sub>D(off)</sub>			26.3	40	ns
Turn-Off Fall Time	t <sub>f</sub>			4.1	6	ns
Body Diode Reverse Recovery Time	t <sub>rr</sub>		I <sub>F</sub> =5A, di/dt=100A/μ s		16	20
Body Diode Reverse Recovery Charge	Q <sub>rr</sub>	I <sub>F</sub> =5A, di/dt=100A/μ s		8.9	12	nC
Maximum Body-Diode Continuous Current	I <sub>S</sub>				2.5	A
Diode Forward Voltage	V <sub>SD</sub>	I <sub>S</sub> =1A, V <sub>GS</sub> =0V		0.71	1	V

■ Typical Characteristics

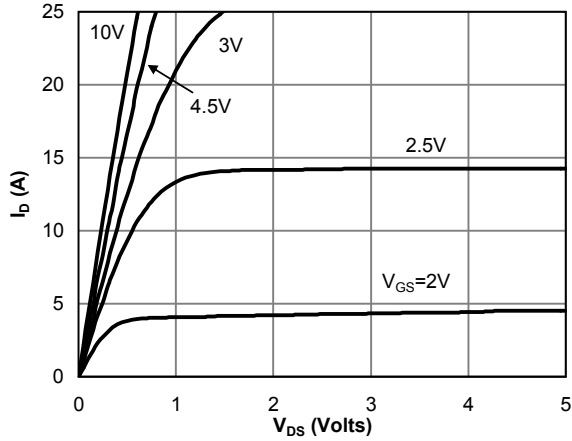

Fig 1: On-Region Characteristics

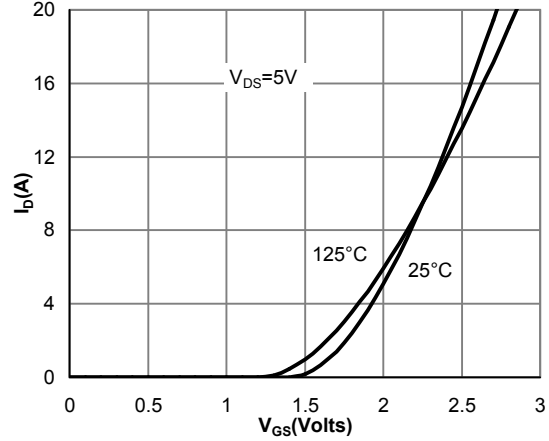

Figure 2: Transfer Characteristics

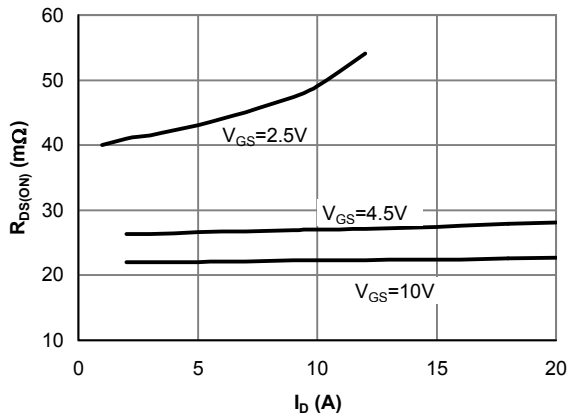

Figure 3: On-Resistance vs. Drain Current and Gate Voltage

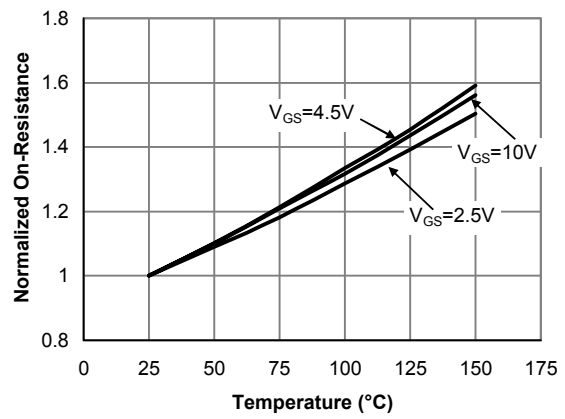

Figure 4: On-Resistance vs. Junction Temperature

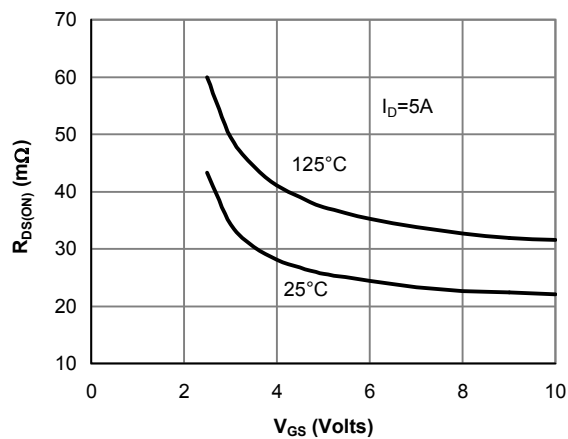

Figure 5: On-Resistance vs. Gate-Source Voltage

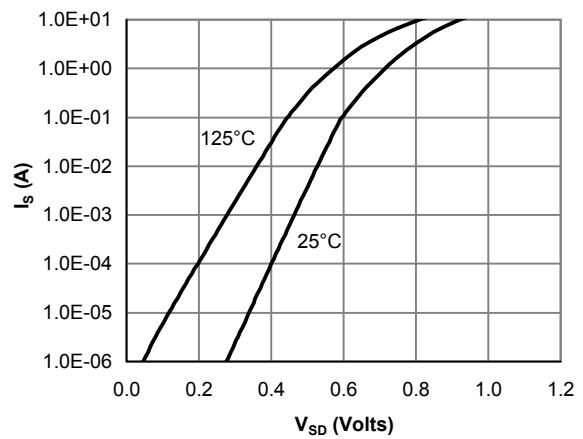

Figure 6: Body-Diode Characteristics

■ Typical Characteristics

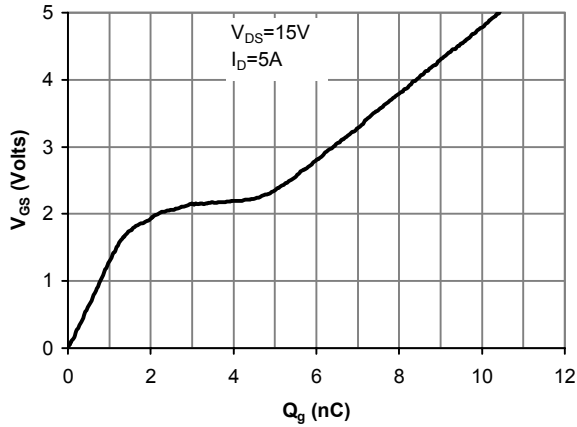

Figure 7: Gate-Charge Characteristics

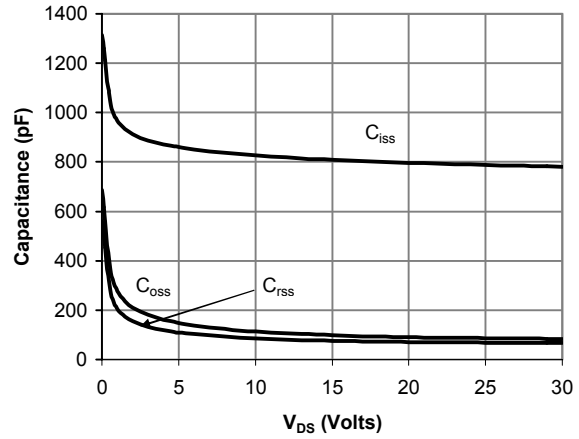

Figure 8: Capacitance Characteristics

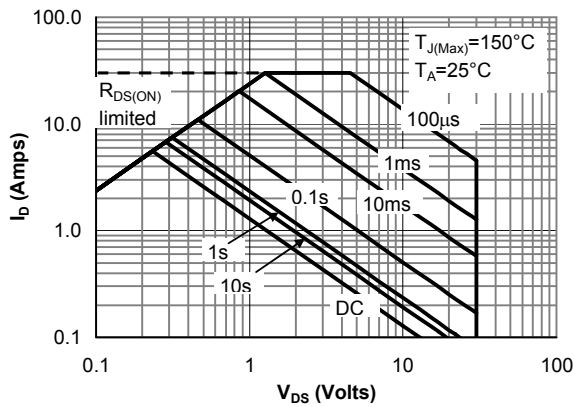

Figure 9: Maximum Forward Biased Safe Operating Area (Note E)

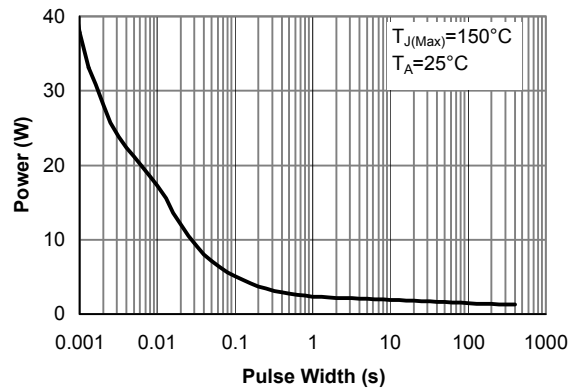

Figure 10: Single Pulse Power Rating Junction-to-Ambient (Note E)

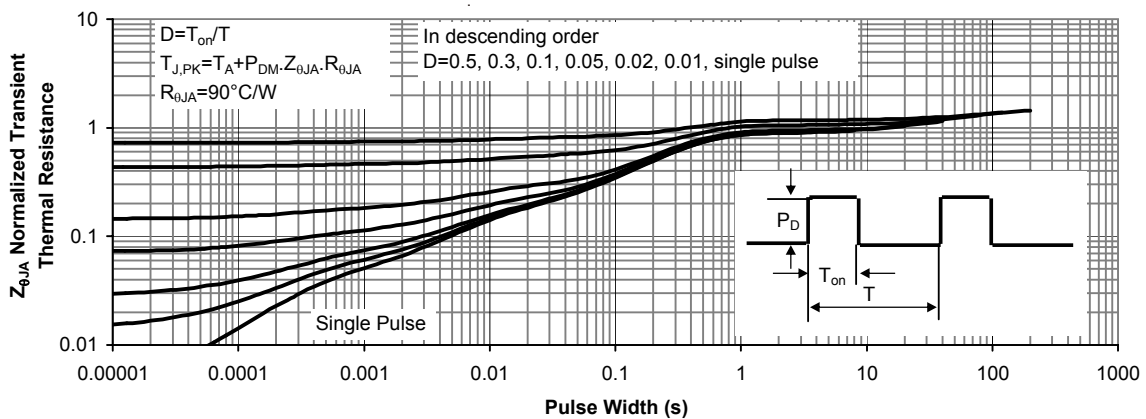
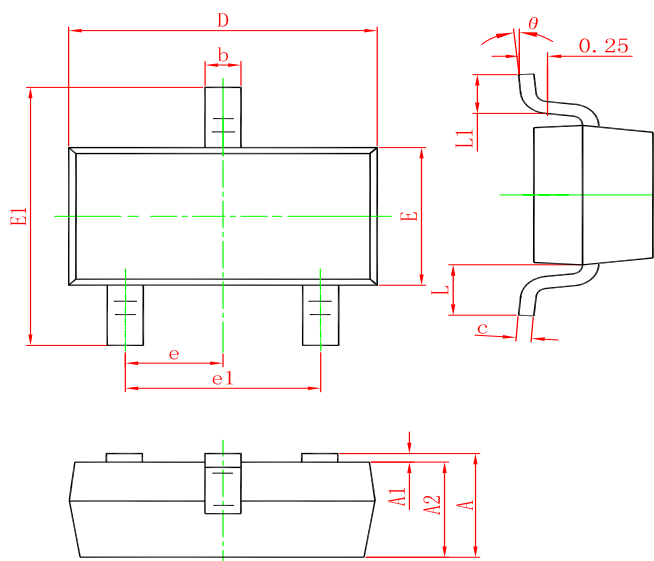

Figure 11: Normalized Maximum Transient Thermal Impedance

SOT-23 PACKAGE OUTLINE DIMENSIONS



Symbol	Dimensions In Millimeters		Dimensions In Inches	
	Min.	Max.	Min.	Max.
A	0.900	1.150	0.035	0.045
A1	0.000	0.100	0.000	0.004
A2	0.900	1.050	0.035	0.041
b	0.300	0.500	0.012	0.020
c	0.080	0.150	0.003	0.006
D	2.800	3.000	0.110	0.118
E	1.200	1.400	0.047	0.055
E1	2.250	2.550	0.089	0.100
e	0.950 TYP.		0.037 TYP.	
e1	1.800	2.000	0.071	0.079
L	0.550 REF.		0.022 REF.	
L1	0.300	0.500	0.012	0.020
θ	0°	8°	0°	8°

Marking

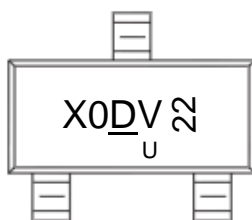

Ordering information

Order code	Package	Baseqty	Deliverymode
UMW AO3400A	SOT-23	3000	Tape and reel