

## Ultrabright 0402 ChipLED

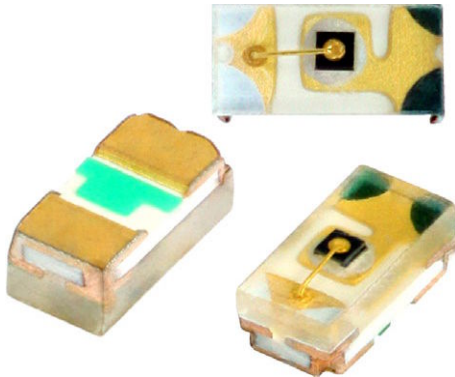

### DESCRIPTION

The new ChipLED series have been designed in the smallest SMD package. This innovative ChipLED technology opens the way to

- smaller products of higher performance
- more design in flexibility
- enhanced applications

The 0402 LED is an obvious solution for small-scale, high brightness products that are expected to work reliable in an arduous environment.

### PRODUCT GROUP AND PACKAGE DATA

- Product group: LED
- Package: SMD 0402 ChipLED
- Product series: standard
- Angle of half intensity:  $\pm 65^\circ$

### FEATURES

- Super thin ChipLED with exceptional brightness 1.0 mm x 0.5 mm x 0.35 mm (L x W x H)
- High reliability PCB based
- Wavelength (470 to 475) nm (blue), typ. 571 nm (yellow green), (587 to 597) nm (yellow), typ. 605 nm (soft orange), typ. 631 nm (super red)
- AllnGaP and InGaN technology
- Viewing angle: extremely wide 130°
- Grouping parameter: luminous intensity, wavelength (except super red and soft orange),  $V_F$
- Available in 8 mm tape on 7" diameter reel
- Compatible to IR reflow soldering
- Preconditioning according to JEDEC® level 2a
- Material categorization: for definitions of compliance please see [www.vishay.com/doc?99912](http://www.vishay.com/doc?99912)



### APPLICATIONS

- Backlight keypads
- Navigation systems
- Cellular phone displays
- Displays for industrial control systems
- Miniaturized color effects
- Traffic displays

PARTS TABLE														
PART	COLOR	LUMINOUS INTENSITY (mcd)			at $I_F$ (mA)	WAVELENGTH (nm)			at $I_F$ (mA)	FORWARD VOLTAGE (V)			at $I_F$ (mA)	TECHNOLOGY
		MIN.	TYP.	MAX.		MIN.	TYP.	MAX.		MIN.	TYP.	MAX.		
VLMS1500-GS08	Super red	18	54	180	20	-	631	-	20	1.80	2.00	2.40	20	AllnGaP
VLMS1501-GS08	Super red	28	54	180	20	-	631	-	20	1.80	2.00	2.40	20	AllnGaP
VLMO1500-GS08	Soft orange	45	90	280	20	598	605	612	20	1.80	2.00	2.40	20	AllnGaP
VLMY1500-GS08	Yellow	28	90	180	20	587	590	597	20	1.80	2.00	2.40	20	AllnGaP
VLMY1501-GS08	Yellow	45	90	180	20	587	590	597	20	1.80	2.00	2.40	20	AllnGaP
VLMG1500-GS08	Yellow green	18	35	112	20	567.5	571	576.5	20	1.90	2.00	2.40	20	AllnGaP
VLMTG1500-GS08	True green	28	-	280	5	520	-	535	5	2.50	-	3.10	5	InGaN
VLMTG1501-GS08	True green	56	-	180	5	520	-	535	5	2.50	-	3.10	5	InGaN
VLMB1500-GS08	Blue	11.2	28	45	5	470	472	475	5	2.65	2.80	3.15	5	InGaN
VLMB1501-GS08	Blue	22.4	28	71	5	470	472	475	5	2.65	2.80	3.15	5	InGaN



<b>ABSOLUTE MAXIMUM RATINGS</b> ( $T_{amb} = 25\text{ }^{\circ}\text{C}$ , unless otherwise specified) <b>VLMS150x, VLMO1500, VLMY150x, VLMG1500</b> (AlInGaP technology)				
PARAMETER	TEST CONDITION	SYMBOL	VALUE	UNIT
Reverse voltage <sup>(1)</sup>		$V_R$	5	V
DC forward current		$I_F$	30	mA
Surge forward current	1/10 duty cycle, 0.1 ms pulse width	$I_{FSM}$	80	mA
Power dissipation	$T_{amb} \leq 25\text{ }^{\circ}\text{C}$	$P_V$	75	mW
Operating temperature range		$T_{amb}$	-30 to +85	$^{\circ}\text{C}$
Storage temperature range		$T_{stg}$	-40 to +85	$^{\circ}\text{C}$
IRED solder conditions	according Vishay specifications	$T_{st}$	260	$^{\circ}\text{C}$

**Note**

<sup>(1)</sup> Driving the LED in reverse direction is suitable for short term application

<b>ABSOLUTE MAXIMUM RATINGS</b> ( $T_{amb} = 25\text{ }^{\circ}\text{C}$ , unless otherwise specified) <b>VLMB150x, VLMTG150x</b> (InGaN technology)				
PARAMETER	TEST CONDITION	SYMBOL	VALUE	UNIT
DC forward current		$I_F$	20	mA
Surge forward current	1/10 duty cycle, 0.1 ms pulse width	$I_{FSM}$	100	mA
Power dissipation	$T_{amb} \leq 25\text{ }^{\circ}\text{C}$	$P_V$	76	mW
Operating temperature range		$T_{amb}$	-20 to +80	$^{\circ}\text{C}$
Storage temperature range		$T_{stg}$	-30 to +100	$^{\circ}\text{C}$
IRED solder conditions	according Vishay specifications	$T_{st}$	260	$^{\circ}\text{C}$

<b>OPTICAL AND ELECTRICAL CHARACTERISTICS</b> ( $T_{amb} = 25\text{ }^{\circ}\text{C}$ , unless otherwise specified) <b>VLMS150x, SUPER RED</b>							
PARAMETER	TEST CONDITION	PART	SYMBOL	MIN.	TYP.	MAX.	UNIT
Luminous intensity	$I_F = 20\text{ mA}$	VLMS1500	$I_V$	18	54	180	mcd
	$I_F = 20\text{ mA}$	VLMS1501	$I_V$	28	54	180	mcd
Dominant wavelength	$I_F = 20\text{ mA}$		$\lambda_d$	-	631	-	nm
Peak wavelength	$I_F = 20\text{ mA}$		$\lambda_p$	-	639	-	nm
Angle of half intensity	$I_F = 20\text{ mA}$		$\varphi$	-	$\pm 65$	-	deg
Spectral line half width	$I_F = 20\text{ mA}$		$\Delta\lambda$	-	20	-	nm
Forward voltage	$I_F = 20\text{ mA}$		$V_F$	1.80	2.0	2.4	V
Reverse current	$V_R = 5\text{ V}$		$I_R$	-	-	10	$\mu\text{A}$

<b>OPTICAL AND ELECTRICAL CHARACTERISTICS</b> ( $T_{amb} = 25\text{ }^{\circ}\text{C}$ , unless otherwise specified) <b>VLMO1500, SOFT ORANGE</b>							
PARAMETER	TEST CONDITION	PART	SYMBOL	MIN.	TYP.	MAX.	UNIT
Luminous intensity	$I_F = 20\text{ mA}$	VLMO1500	$I_V$	45	90	280	mcd
Dominant wavelength	$I_F = 20\text{ mA}$		$\lambda_d$	598	605	612	nm
Peak wavelength	$I_F = 20\text{ mA}$		$\lambda_p$	-	611	-	nm
Angle of half intensity	$I_F = 20\text{ mA}$		$\varphi$	-	$\pm 65$	-	deg
Spectral line half width	$I_F = 20\text{ mA}$		$\Delta\lambda$	-	17	-	nm
Forward voltage	$I_F = 20\text{ mA}$		$V_F$	1.80	2.0	2.4	V
Reverse current	$V_R = 5\text{ V}$		$I_R$	-	-	10	$\mu\text{A}$

**OPTICAL AND ELECTRICAL CHARACTERISTICS** ( $T_{amb} = 25\text{ }^{\circ}\text{C}$ , unless otherwise specified)  
**VLMY150x, YELLOW**

PARAMETER	TEST CONDITION	PART	SYMBOL	MIN.	TYP.	MAX.	UNIT
Luminous intensity	$I_F = 20\text{ mA}$	VLMY1500	$I_V$	28	90	180	mcd
	$I_F = 20\text{ mA}$	VLMY1501	$I_V$	45	90	180	mcd
Dominant wavelength	$I_F = 20\text{ mA}$		$\lambda_d$	587	590	597	nm
Peak wavelength	$I_F = 20\text{ mA}$		$\lambda_p$	-	588	-	nm
Angle of half intensity	$I_F = 20\text{ mA}$		$\phi$	-	$\pm 65$	-	deg
Spectral line half width	$I_F = 20\text{ mA}$		$\Delta\lambda$	-	15	-	nm
Forward voltage	$I_F = 20\text{ mA}$		$V_F$	1.80	2.0	2.4	V
Reverse current	$V_R = 5\text{ V}$		$I_R$	-	-	10	$\mu\text{A}$

**OPTICAL AND ELECTRICAL CHARACTERISTICS** ( $T_{amb} = 25\text{ }^{\circ}\text{C}$ , unless otherwise specified)  
**VLMG1500, YELLOW GREEN**

PARAMETER	TEST CONDITION	PART	SYMBOL	MIN.	TYP.	MAX.	UNIT
Luminous intensity	$I_F = 20\text{ mA}$	VLMG1500	$I_V$	18	35	112	mcd
Dominant wavelength	$I_F = 20\text{ mA}$		$\lambda_d$	567.5	571	576.5	nm
Peak wavelength	$I_F = 20\text{ mA}$		$\lambda_p$	-	574	-	nm
Angle of half intensity	$I_F = 20\text{ mA}$		$\phi$	-	$\pm 65$	-	deg
Spectral line half width	$I_F = 20\text{ mA}$		$\Delta\lambda$	-	15	-	nm
Forward voltage	$I_F = 20\text{ mA}$		$V_F$	1.9	2.0	2.4	V
Junction capacitance	$V_R = 0\text{ V}$ , $f = 1\text{ MHz}$		$C_j$	-	40	-	pF
Reverse current	$V_R = 5\text{ V}$		$I_R$	-	-	10	$\mu\text{A}$

**OPTICAL AND ELECTRICAL CHARACTERISTICS** ( $T_{amb} = 25\text{ }^{\circ}\text{C}$ , unless otherwise specified)  
**VLMTG150x, TRUE GREEN**

PARAMETER	TEST CONDITION	PART	SYMBOL	MIN.	TYP.	MAX.	UNIT
Luminous intensity	$I_F = 5\text{ mA}$	VLMTG1500	$I_V$	28.0	-	280	mcd
	$I_F = 5\text{ mA}$	VLMTG1501	$I_V$	56	-	180	mcd
Dominant wavelength	$I_F = 5\text{ mA}$		$\lambda_d$	520	-	535	nm
Peak wavelength	$I_F = 5\text{ mA}$		$\lambda_p$	-	525	-	nm
Angle of half intensity	$I_F = 5\text{ mA}$		$\phi$	-	$\pm 65$	-	deg
Spectral line half width	$I_F = 5\text{ mA}$		$\Delta\lambda$	-	35	-	nm
Forward voltage	$I_F = 5\text{ mA}$		$V_F$	2.50	-	3.10	V
Reverse current	$V_R = 5\text{ V}$		$I_R$	-	-	10	$\mu\text{A}$

**OPTICAL AND ELECTRICAL CHARACTERISTICS** ( $T_{amb} = 25\text{ }^{\circ}\text{C}$ , unless otherwise specified)  
**VLMB150x, BLUE**

PARAMETER	TEST CONDITION	PART	SYMBOL	MIN.	TYP.	MAX.	UNIT
Luminous intensity	$I_F = 5\text{ mA}$	VLMB1500	$I_V$	11.2	28	45	mcd
	$I_F = 5\text{ mA}$	VLMB1501	$I_V$	22.4	28	71	mcd
Dominant wavelength	$I_F = 5\text{ mA}$		$\lambda_d$	470	472	475	nm
Peak wavelength	$I_F = 5\text{ mA}$		$\lambda_p$	-	468	-	nm
Angle of half intensity	$I_F = 5\text{ mA}$		$\phi$	-	$\pm 65$	-	deg
Spectral line half width	$I_F = 5\text{ mA}$		$\Delta\lambda$	-	25	-	nm
Forward voltage	$I_F = 5\text{ mA}$		$V_F$	2.65	2.80	3.15	V
Reverse current	$V_R = 5\text{ V}$		$I_R$	-	-	10	$\mu\text{A}$



LUMINOUS INTENSITY CLASSIFICATION		
GROUP	LUMINOUS INTENSITY (mcd)	
	MIN.	MAX.
VLMS150x, VLMO1500, VLMY150x, VLMTG1500, VLMG1500, VLMB1500		
L	11.2	18
M	18	28
N	28	45
P	45	71
Q	71	112
R	112	180
S	180	280
T	280	450
VLMB1501, VLMTG1501		
M2	22.4	28
N1	28	35.5
N2	35.5	45
P1	45	56
P2	56	71
Q1	71	90
Q2	90	112
R1	112	140
R2	140	180

**Note**

- Luminous intensity is tested at a current pulse duration of 25 ms and an accuracy of ± 15 %.
- The above type numbers represent the order groups which include only a few brightness groups. Only one group will be shipped on each reel (there will be no mixing of two groups on each reel). In order to ensure availability, single brightness groups will not be orderable.
- In a similar manner for colors where wavelength groups are measured and binned, single wavelength groups will be shipped in any one reel.
- In order to ensure availability, single wavelength groups will not be orderable.

COLOR CLASSIFICATION			
COLOR	GROUP	DOMINANT WAVELENGTH (nm)	
		MIN.	MAX.
Yellow	J	587	589.5
	K	589.5	592
	L	592	594.5
	M	594.5	597
Yellow green	C	567.5	570.5
	D	570.5	573.5
	E	573.5	576.5
True green	AP	520	525
	AQ	525	530
	AR	530	535
Blue	AD	470	475

**Note**

- Wavelengths are tested at a current pulse duration of 25 ms and an accuracy of ± 1 nm.

FORWARD VOLTAGE CLASSIFICATION			
COLOR	GROUP	FORWARD VOLTAGE (V)	
		MIN.	MAX.
Yellow	D2	1.8	2.0
	D3	2.0	2.2
	D4	2.2	2.4
Yellow green	4	1.9	2
	5	2	2.1
	6	2.1	2.2
	7	2.2	2.3
True green	8	2.3	2.4
	E6	2.50	2.70
	E7	2.70	2.90
Blue	E8	2.90	3.10
	1	2.65	2.75
	2	2.75	2.85
	3	2.85	2.95
	4	2.95	3.05
	5	3.05	3.15

**Note**

- Forward voltage is measured with a tolerance of ± 0.1 V.



### TYPICAL CHARACTERISTICS (T<sub>amb</sub> = 25 °C, unless otherwise specified)

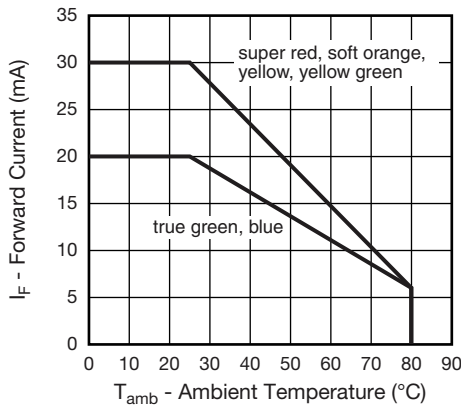

Fig. 1 - Forward Current vs. Ambient Temperature

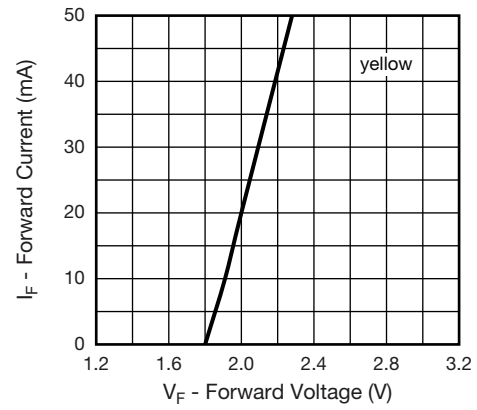

Fig. 4 - Forward Current vs. Forward Voltage (yellow)

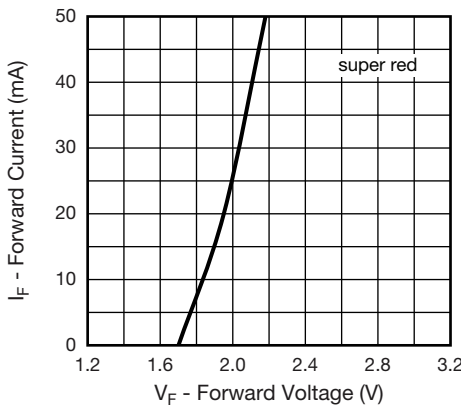

Fig. 2 - Forward Current vs. Forward Voltage (super red)

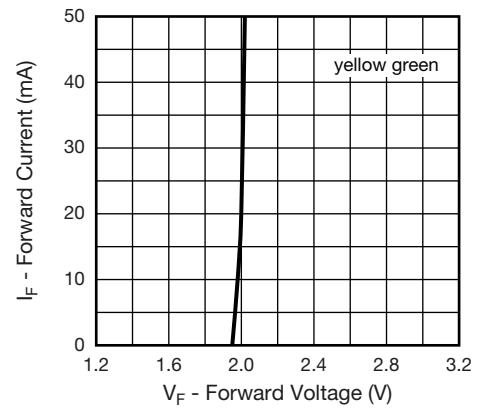

Fig. 5 - Forward Current vs. Forward Voltage (yellow green)

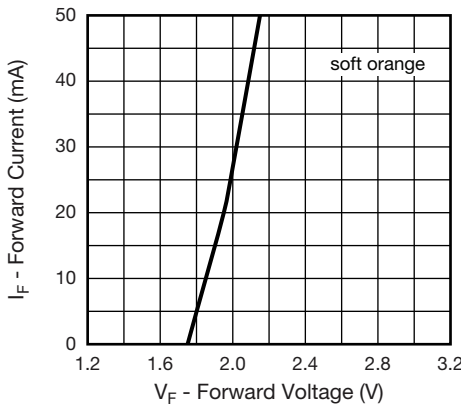

Fig. 3 - Forward Current vs. Forward Voltage (soft orange)

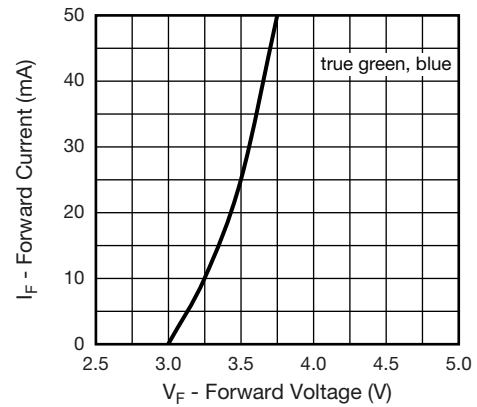

Fig. 6 - Forward Current vs. Forward Voltage (true green, blue)

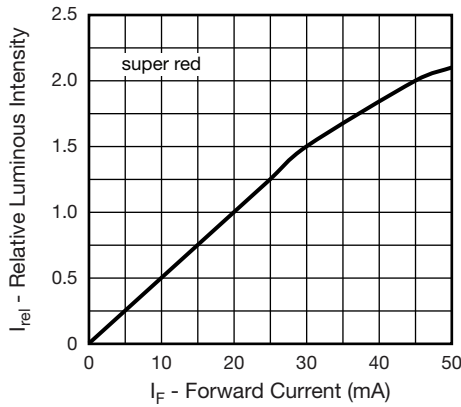

Fig. 7 - Relative Luminous Intensity vs. Forward Current (super red)

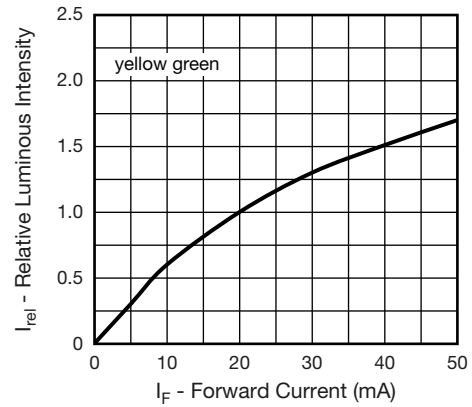

Fig. 10 - Relative Luminous Intensity vs. Forward Current (yellow green)

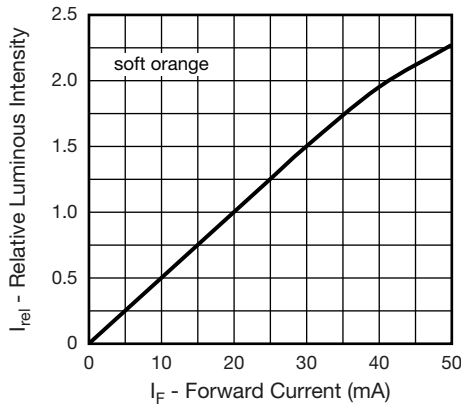

Fig. 8 - Relative Luminous Intensity vs. Forward Current (soft orange)

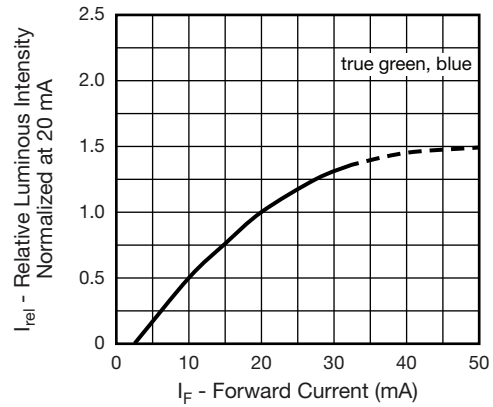

Fig. 11 - Relative Luminous Intensity vs. Forward Current (true green, blue)

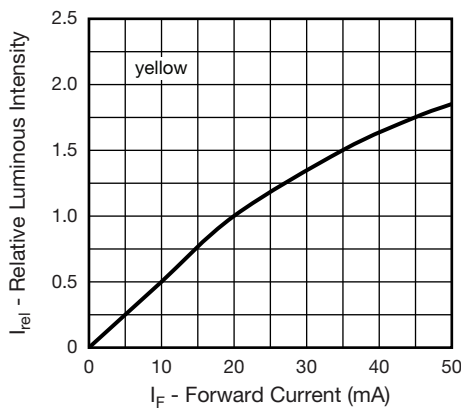

Fig. 9 - Relative Luminous Intensity vs. Forward Current (yellow)

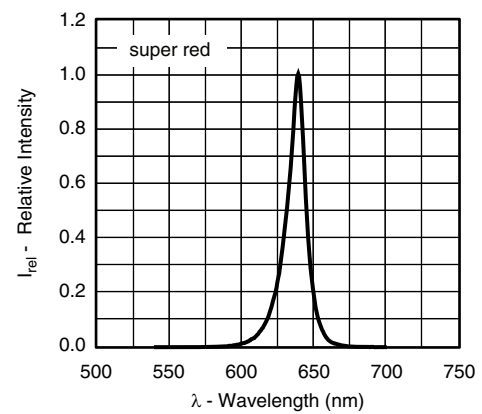

Fig. 12 - Relative Intensity vs. Wavelength (super red)

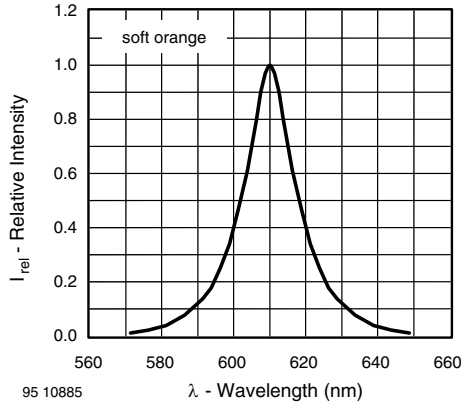

Fig. 13 - Relative Intensity vs. Wavelength (soft orange)

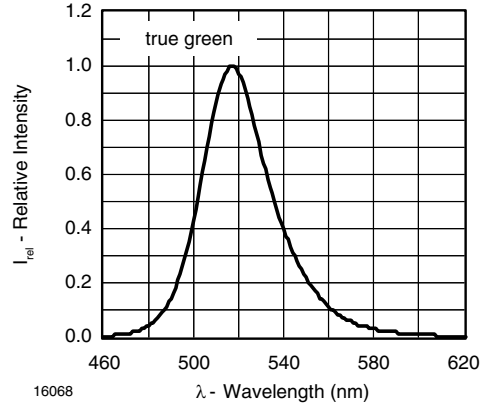

Fig. 16 - Relative Intensity vs. Wavelength (true green)

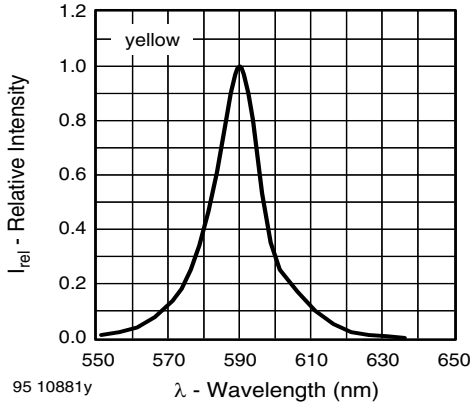

Fig. 14 - Relative Intensity vs. Wavelength (yellow)

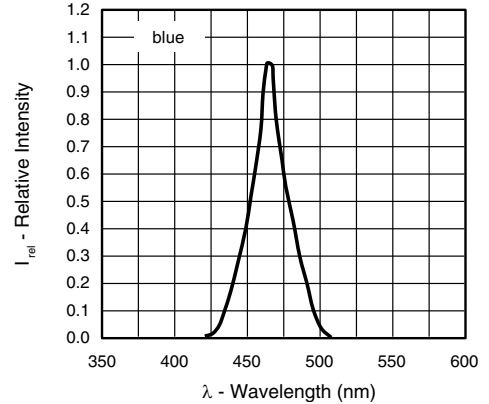

Fig. 17 - Relative Intensity vs. Wavelength (blue)

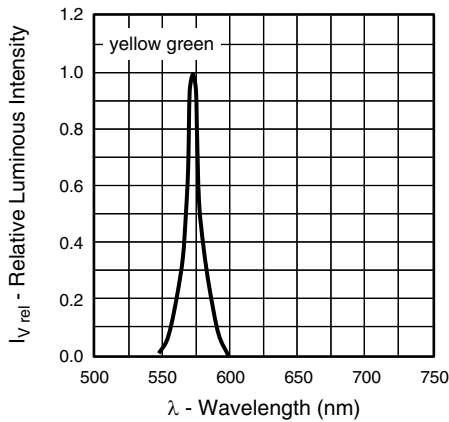

Fig. 15 - Relative Intensity vs. Wavelength (yellow green)

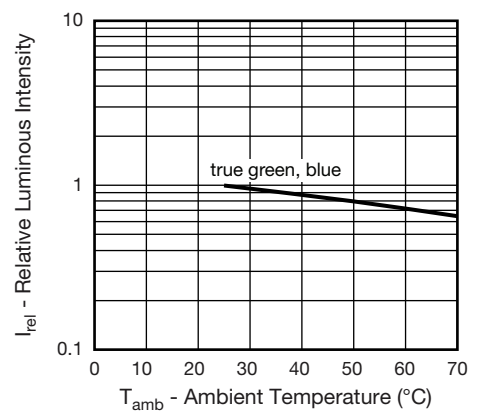

Fig. 18 - Relative Luminous Intensity vs. Ambient Temperature

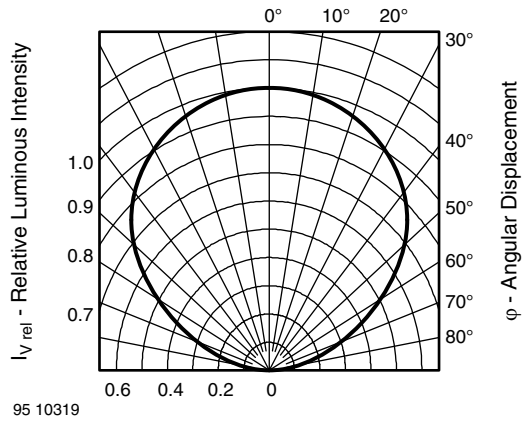
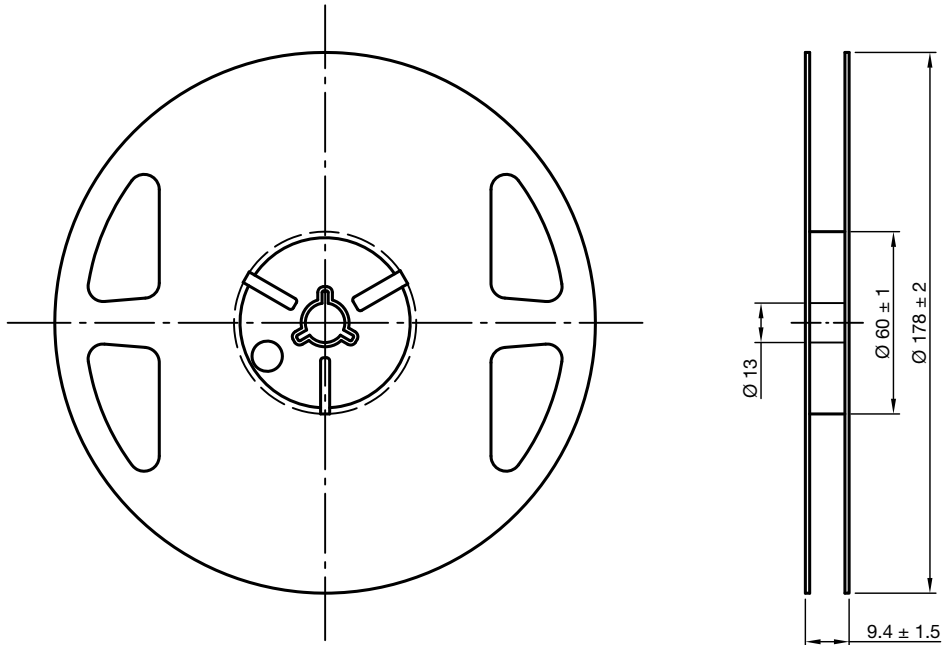
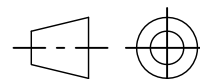

Fig. 19 - Relative Luminous Intensity vs. Angular Displacement

**REEL DIMENSIONS** in millimeters



Drawing-No.: 9.800-5122.01-4  
 Issue: 2; 03.11.11  
 22611



technical drawings  
 according to DIN  
 specifications

Reels come in quantity of 3000 units.  
 MOQ: 3 reels (9000 pcs)





TAPE DIMENSIONS in millimeters

VLMx150x-Series

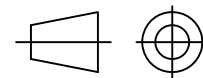
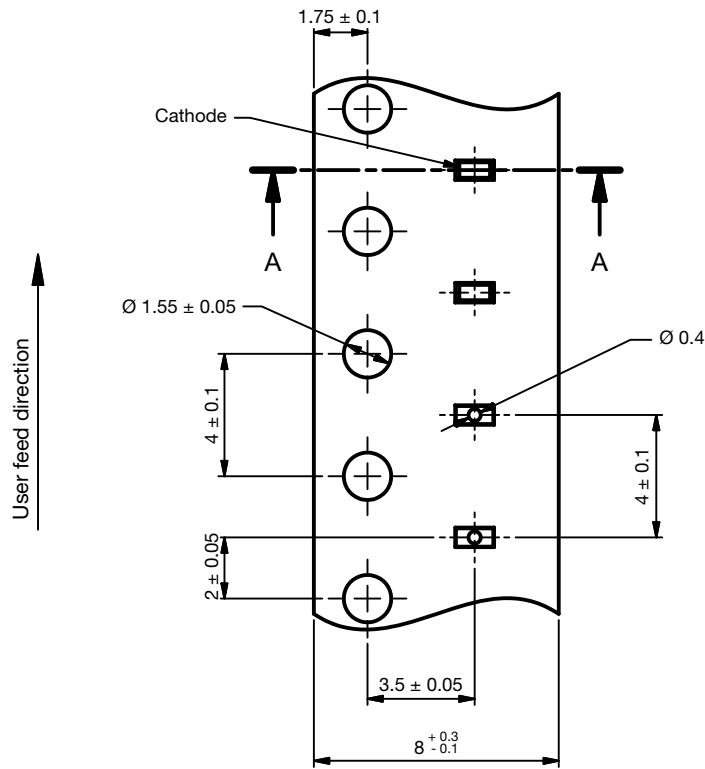
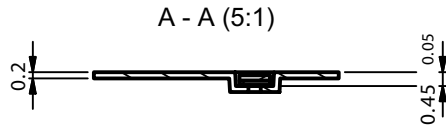

Technical drawings according to DIN specification.

Drawing-No.: 9.700-5388.01-4  
Issue: 1; 20.03.12



**PACKAGE DIMENSIONS** in millimeters

**VLMx150x-Series**

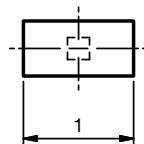
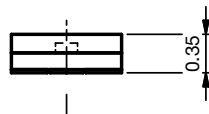
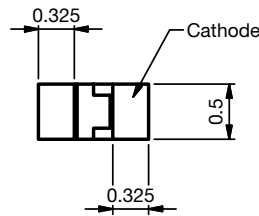

Recommended solder pad footprint

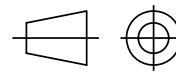
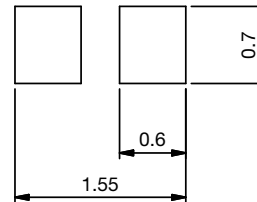

Technical drawings according to DIN specification

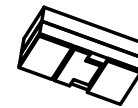

Not indicated tolerances  $\pm 0.2$

Drawing-No.: 6.541-5096.01-4  
Issue: 1; 20.03.12

**SOLDERING PROFILE**

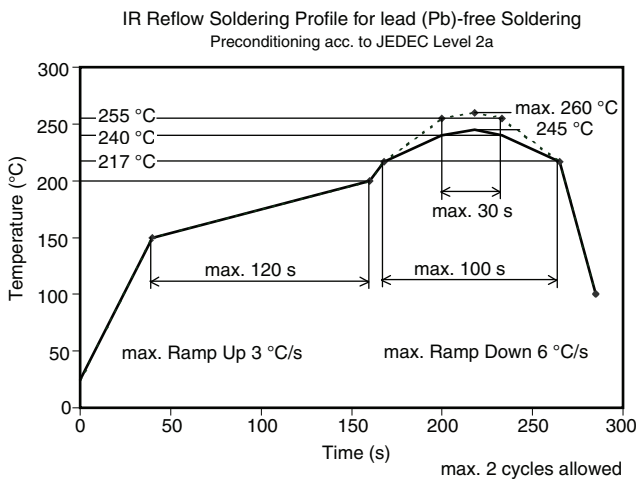

Fig. 20 - Vishay Lead (Pb)-free Reflow Soldering Profile (according to J-STD-020C)

**BAR CODE PRODUCT LABEL** (Example only)



- A) 2D barcode
- B) Vishay part number
- C) Quantity
- D) PTC = selection code (binning)
- E) Code of manufacturing plant
- F) Batch = date code: year / week / plant code
- G) Region code
- H) SL = sales location
- I) Terminations finishing
- K) Lead (Pb)-free symbol
- L) Halogen-free symbol
- M) RoHS symbol



**DRY PACKING**

The reel is packed in an anti-humidity bag to protect the devices from absorbing moisture during transportation and storage.

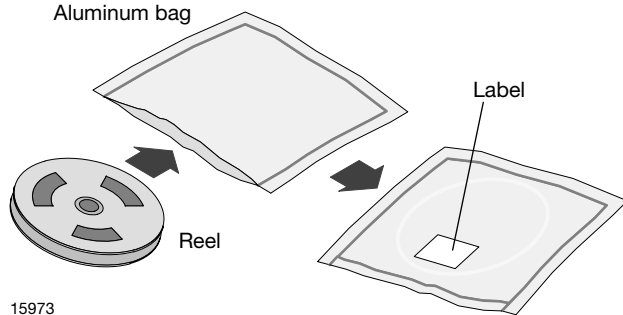

15973

**FINAL PACKING**

The sealed reel is packed into a cardboard box. A secondary cardboard box is used for shipping purposes.

**RECOMMENDED METHOD OF STORAGE**

Dry box storage is recommended as soon as the aluminum bag has been opened to prevent moisture absorption. The following conditions should be observed, if dry boxes are not available:

- Storage temperature 10 °C to 30 °C
- Storage humidity ≤ 60 % RH max.

After more than 672 h under these conditions moisture content will be too high for reflow soldering.

In case of moisture absorption, the devices will recover to the former condition by drying under the following condition:

- 192 h at 40 °C + 5 °C / - 0 °C and < 5 % RH (dry air/nitrogen) or
- 96 h at 60 °C + 5 °C and < 5 % RH for all device containers or
- 24 h at 100 °C + 5 °C not suitable for reel or tubes.

An EIA JEDEC standard JESD22-A112 level 2a label is included on all dry bags.

**ESD PRECAUTION**

Proper storage and handling procedures should be followed to prevent ESD damage to the devices especially when they are removed from the antistatic shielding bag. Electrostatic sensitive devices warning labels are on the packaging.

**VISHAY SEMICONDUCTORS STANDARD BAR CODE LABELS**

The Vishay Semiconductors standard bar code labels are printed at final packing areas. The labels are on each packing unit and contain Vishay Semiconductors specific data.

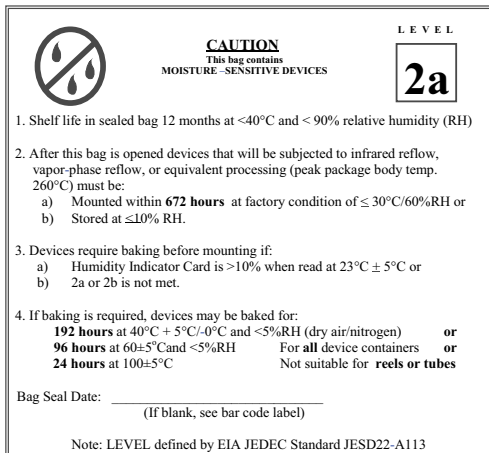

Example of JESD22-A112 Level 2a Label



## **Disclaimer**

ALL PRODUCT, PRODUCT SPECIFICATIONS AND DATA ARE SUBJECT TO CHANGE WITHOUT NOTICE TO IMPROVE RELIABILITY, FUNCTION OR DESIGN OR OTHERWISE.

Vishay Intertechnology, Inc., its affiliates, agents, and employees, and all persons acting on its or their behalf (collectively, "Vishay"), disclaim any and all liability for any errors, inaccuracies or incompleteness contained in any datasheet or in any other disclosure relating to any product.

Vishay makes no warranty, representation or guarantee regarding the suitability of the products for any particular purpose or the continuing production of any product. To the maximum extent permitted by applicable law, Vishay disclaims (i) any and all liability arising out of the application or use of any product, (ii) any and all liability, including without limitation special, consequential or incidental damages, and (iii) any and all implied warranties, including warranties of fitness for particular purpose, non-infringement and merchantability.

Statements regarding the suitability of products for certain types of applications are based on Vishay's knowledge of typical requirements that are often placed on Vishay products in generic applications. Such statements are not binding statements about the suitability of products for a particular application. It is the customer's responsibility to validate that a particular product with the properties described in the product specification is suitable for use in a particular application. Parameters provided in datasheets and / or specifications may vary in different applications and performance may vary over time. All operating parameters, including typical parameters, must be validated for each customer application by the customer's technical experts. Product specifications do not expand or otherwise modify Vishay's terms and conditions of purchase, including but not limited to the warranty expressed therein.

Except as expressly indicated in writing, Vishay products are not designed for use in medical, life-saving, or life-sustaining applications or for any other application in which the failure of the Vishay product could result in personal injury or death. Customers using or selling Vishay products not expressly indicated for use in such applications do so at their own risk. Please contact authorized Vishay personnel to obtain written terms and conditions regarding products designed for such applications.

No license, express or implied, by estoppel or otherwise, to any intellectual property rights is granted by this document or by any conduct of Vishay. Product names and markings noted herein may be trademarks of their respective owners.