

# 2A Ultra-Small Controlled Load Switch with Auto-Discharge Path

## NCP334, NCP335

The NCP334 and NCP335 are low Ron MOSFET controlled by external logic pin, allowing optimization of battery life, and portable device autonomy.

Indeed, due to a current consumption optimization with PMOS structure, leakage currents are eliminated by isolating connected IC's on the battery when not used.

Output discharge path is also embedded to eliminate residual voltages on the output rail in the NCP335.

Proposed in wide input voltage range from 1.2 V to 5.5 V, and a very small 0.96 x 0.96 mm WLCSP4, 0.5 mm pitch.

### Features

- 1.2 V – 5.5 V Operating Range
- 47 mΩ P MOSFET at 3.3 V
- DC Current Up to 2 A
- Output Auto-discharge (NCP335)
- Active high EN pin
- WLCSP4 0.96 x 0.96 mm
- ESD Ratings: 4 kV Human Body Model, 2 kV CDM,
- 250 V Machine Model
- These are Pb-Free Devices

### Typical Applications

- Mobile Phones
- Tablets
- Digital Cameras
- GPS
- Portable Devices



WLCSP4  
CASE 567FG

### MARKING DIAGRAM

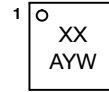

XX = Specific Device Code  
 A = Assembly Location  
 Y = Year  
 W = Work Week

### PIN DIAGRAM

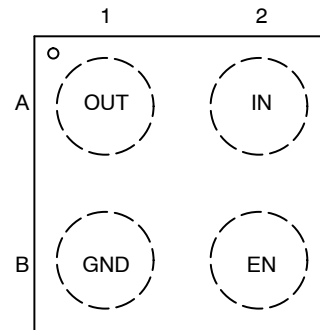

(Top View)

### ORDERING INFORMATION

See detailed ordering, marking and shipping information on page 9 of this data sheet.

## NCP334, NCP335

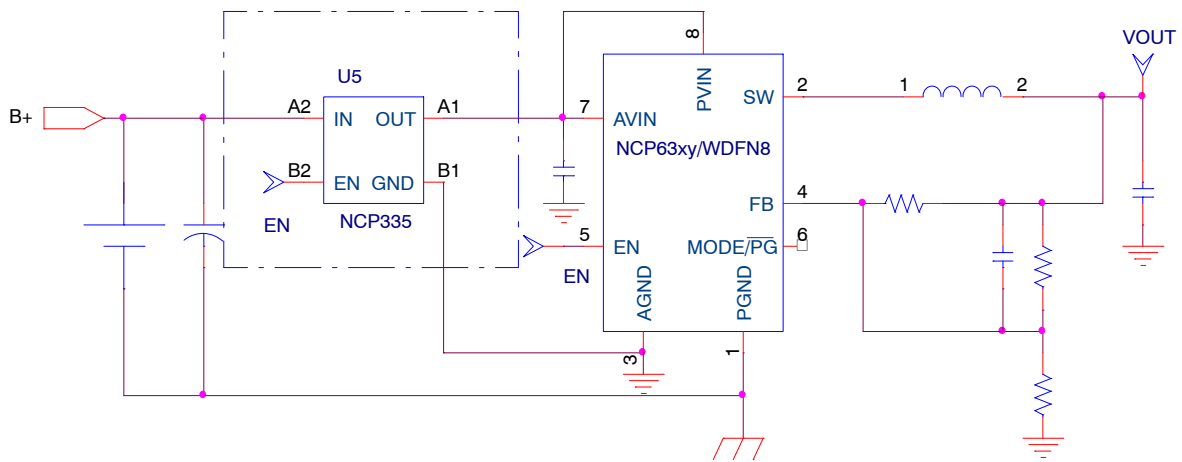
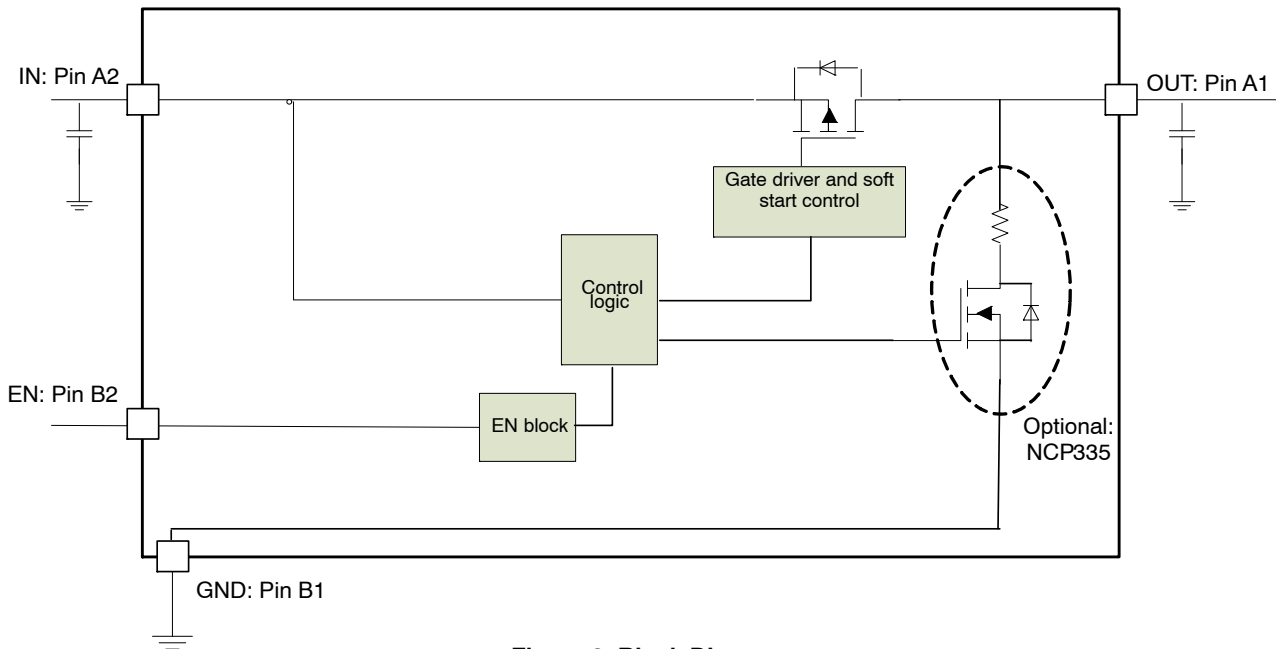

**Figure 1. Typical Application Circuit**

### PIN FUNCTION DESCRIPTION

Pin Name	Pin Number	Type	Description
IN	A2	POWER	Load-switch input voltage; connect a 1 $\mu$ F or greater ceramic capacitor from IN to GND as close as possible to the IC.
GND	B1	POWER	Ground connection.
EN	B2	INPUT	Enable input, logic high turns on power switch.
OUT	A1	OUTPUT	Load-switch output; connect a 1 $\mu$ F ceramic capacitor from OUT to GND as close as possible to the IC is recommended.

### BLOCK DIAGRAM



**Figure 2. Block Diagram**

# NCP334, NCP335

## MAXIMUM RATINGS

Rating	Symbol	Value	Unit
IN, OUT, EN, Pins	$V_{EN}, V_{IN}, V_{OUT}$	0.3 to + 7.0	V
From IN to OUT Pins: Input/Output	$V_{IN}, V_{OUT}$	0 to + 7.0	V
Maximum Junction Temperature	$T_J$	-40 to + 125	°C
Storage Temperature Range	$T_{STG}$	-40 to + 150	°C
Human Body Model (HBM) ESD Rating are (Notes 1 and 2)	ESD HBM	4000	V
Machine Model (MM) ESD Rating are (Notes 1 and 2)	ESD MM	250	V
Charge Device Model (CDM) ESD Rating are (Notes 1 and 2)	ESD CDM	2000	V
Latch-up protection (Note 3) – Pins IN, OUT, EN	LU	100	mA
Moisture Sensitivity (Note 4)	MSL	Level 1	

Stresses exceeding those listed in the Maximum Ratings table may damage the device. If any of these limits are exceeded, device functionality should not be assumed, damage may occur and reliability may be affected.

- According to JEDEC standard JESD22-A108.
- This device series contains ESD protection and passes the following tests:  
Human Body Model (HBM)  $\pm 4.0$  kV per JEDEC standard: JESD22-A114 for all pins.  
Machine Model (MM)  $\pm 250$  V per JEDEC standard: JESD22-A115 for all pins.  
Charge Device Model (CDM)  $\pm 2.0$  kV per JEDEC standard: JESD22-C101 for all pins.
- Latch up Current Maximum Rating:  $\pm 100$  mA per JEDEC standard: JESD78 class II.
- Moisture Sensitivity Level (MSL): 1 per IPC/JEDEC standard: J-STD-020.

## OPERATING CONDITIONS

Symbol	Parameter	Conditions	Min	Typ	Max	Unit	
$V_{IN}$	Operational Power Supply		1.2		5.5	V	
$V_{EN}$	Enable Voltage		0		5.5		
$T_A$	Ambient Temperature Range		-40	25	+ 85	°C	
$C_{IN}$	Decoupling input capacitor		1			$\mu F$	
$C_{OUT}$	Decoupling output capacitor		1			$\mu F$	
$R_{\theta JA}$	Thermal Resistance Junction to Air	WLCSP package (Note 5)		100		°C/W	
$I_{OUT}$	Maximum DC current				2	A	
$P_D$	Power Dissipation Rating (Note 6)	$T_A \leq 25$ °C	WLCSP package		0.5		W
		$T_A = 85$ °C	WLCSP package		0.2		W

- The  $R_{\theta JA}$  is dependent of the PCB heat dissipation and thermal via.
- The maximum power dissipation ( $P_D$ ) is given by the following formula:

$$P_D = \frac{T_{JMAX} - T_A}{R_{\theta JA}}$$

# NCP334, NCP335

**ELECTRICAL CHARACTERISTICS** Min and Max Limits apply for  $T_A$  between  $-40^{\circ}\text{C}$  to  $+85^{\circ}\text{C}$  for  $V_{IN}$  between 1.2 V to 5.5 V (Unless otherwise noted). Typical values are referenced to  $T_A = +25^{\circ}\text{C}$  and  $V_{IN} = 4\text{ V}$  (Unless otherwise noted).

Symbol	Parameter	Conditions		Min	Typ	Max	Unit
<b>POWER SWITCH</b>							
$R_{DS(on)}$	Static drain-source on-state resistance	$V_{IN} = 5.5\text{ V}$	$T_A = 25^{\circ}\text{C}, I = 200\text{ mA}$ (Note 8)		38	40	$\text{m}\Omega$
		$V_{IN} = 4.2\text{ V}$	$T_A = 25^{\circ}\text{C}, I = 200\text{ mA}$		42	46	
		$V_{IN} = 3.3\text{ V}$	$T_A = 25^{\circ}\text{C}, I = 200\text{ mA}$		47	52	
		$V_{IN} = 1.8\text{ V}$	$T_A = 25^{\circ}\text{C}, I = 200\text{ mA}$		76	87	
			Full			100	
		$V_{IN} = 1.2\text{ V}$	$T_A = 25^{\circ}\text{C}, I = 200\text{ mA}$		211	420	
$R_{DIS}$	Output discharge path	EN = low	$V_{IN} = 3.3\text{ V}$ , NCP335 only		65	110	$\Omega$
$T_R$	Output rise time	$V_{IN} = 3.6\text{ V}$	$C_{LOAD} = 1\ \mu\text{F}$ , $R_{LOAD} = 25\ \Omega$ (Note 7)		71		$\mu\text{s}$
$T_F$	Output fall time	$V_{IN} = 3.6\text{ V}$	$C_{LOAD} = 1\ \mu\text{F}$ , $R_{LOAD} = 25\ \Omega$ (Note 7)		42		$\mu\text{s}$
$T_{on}$	Gate turn on	$V_{IN} = 3.6\text{ V}$	Gate turn on + Output rise time		116		$\mu\text{s}$
$T_{en}$	Enable time	$V_{IN} = 3.6\text{ V}$	From EN low to high to $V_{OUT} = 10\%$ of fully on		45		$\mu\text{s}$
$V_{IH}$	High-level input voltage			0.9			V
$V_{IL}$	Low-level input voltage					0.5	V
$R_{EN}$	Pull down resistor				5		$\text{M}\Omega$

### QUIESCENT CURRENT

$I_Q$	Current consumption	$V_{IN} = 3.3\text{ V}$ , EN = low, No load				1	$\mu\text{A}$
		$V_{IN} = 3.3\text{ V}$ , EN = high, No load				1	$\mu\text{A}$

7. Parameters are guaranteed for  $C_{LOAD}$  and  $R_{LOAD}$  connected to the OUT pin with respect to the ground  
 8. Guaranteed by design and characterization, not production tested.

### TIMINGS

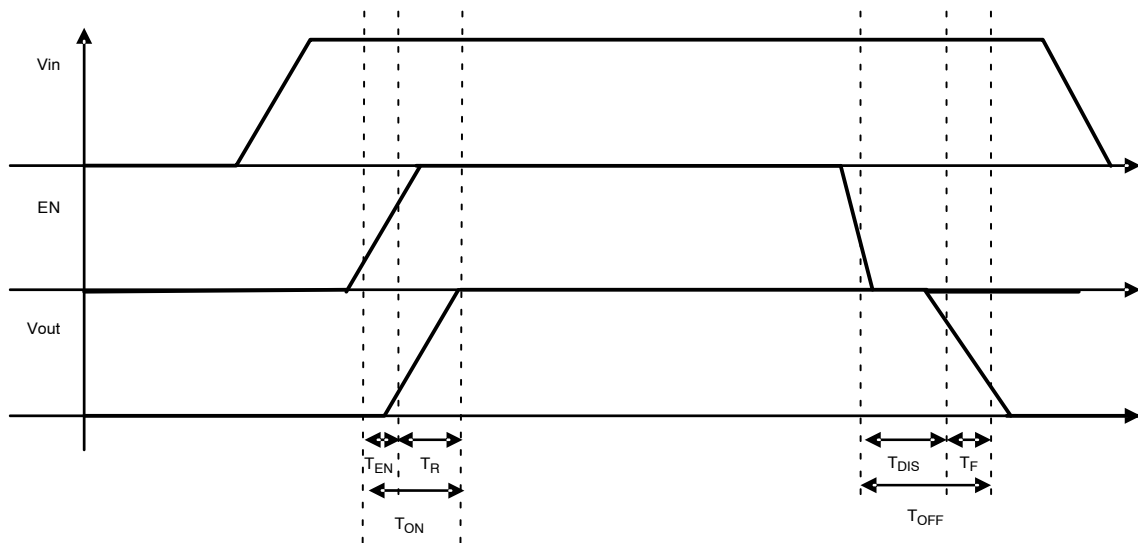

**Figure 3. Enable, Rise and fall time**

# NCP334, NCP335

## TYPICAL CHARACTERISTICS

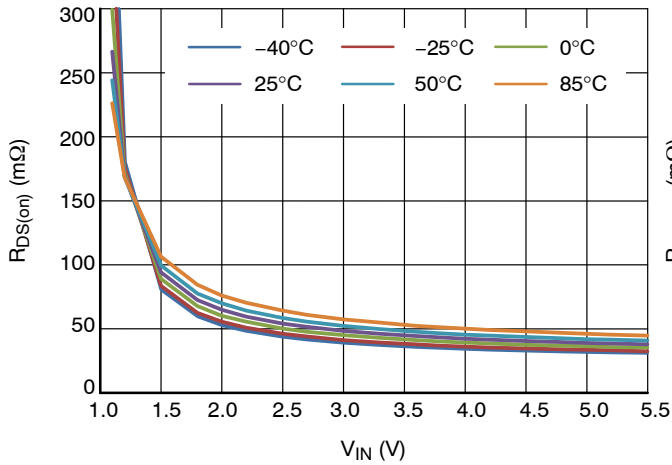

Figure 4.  $R_{DS(on)}$  ( $m\Omega$ ) vs.  $V_{IN}$  (V)

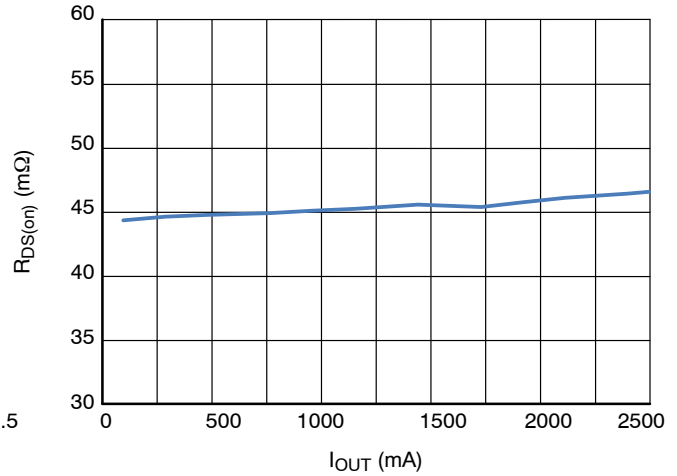

Figure 5.  $R_{DS(on)}$  ( $m\Omega$ ) vs.  $I_{OUT}$  (mA) at 3.6 V

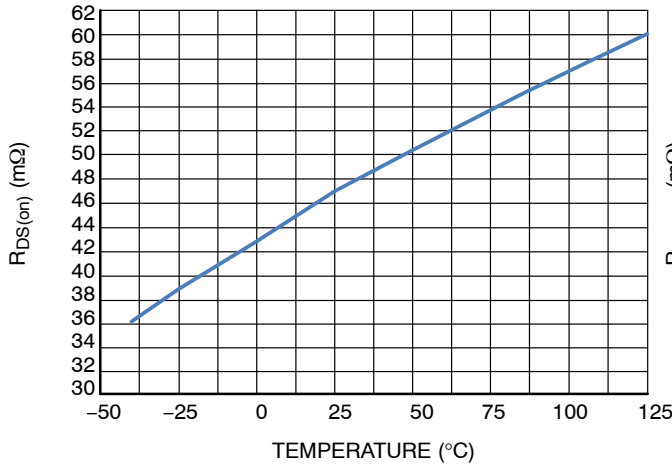

Figure 6.  $R_{DS(on)}$  ( $m\Omega$ ) vs. Temperature ( $^{\circ}\text{C}$ ) at 3.3 V,  $I_{load}$  100 mA

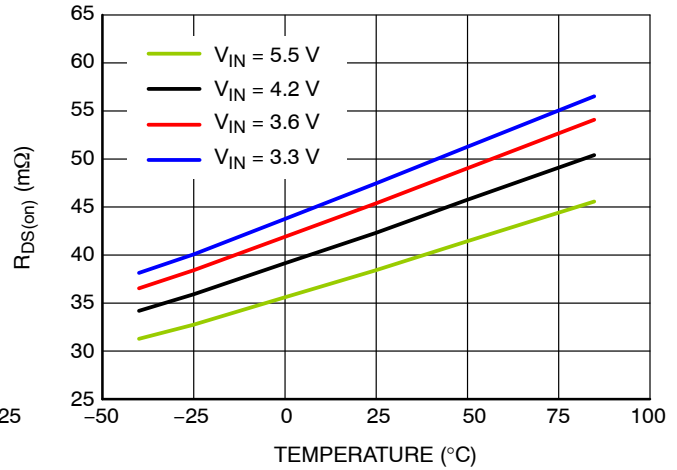

Figure 7.  $R_{DS(on)}$  ( $m\Omega$ ) vs. Temperature ( $^{\circ}\text{C}$ ),  $I_{load}$  2 A

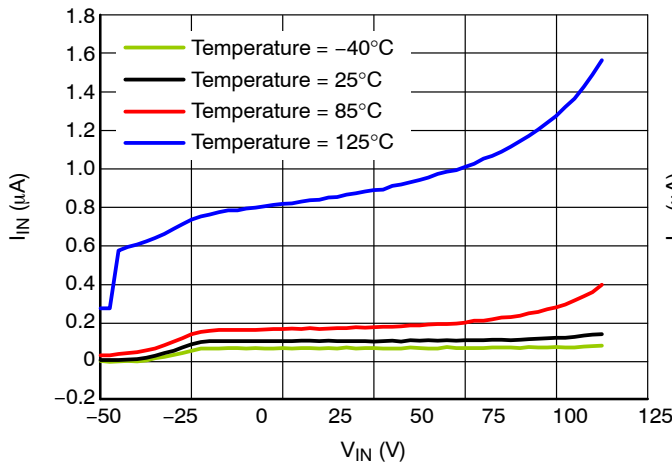

Figure 8. Standby Current ( $\mu\text{A}$ ) versus  $V_{IN}$  (V), No Load

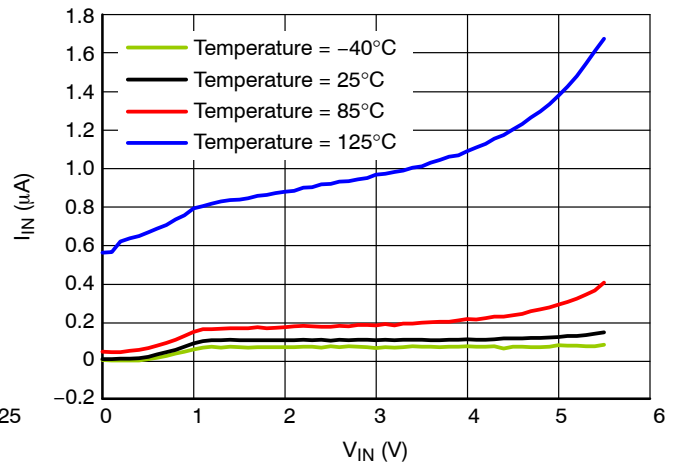

Figure 9. Standby Current ( $\mu\text{A}$ ) versus  $V_{IN}$  (V),  $V_{out}$  Short to GND.

# NCP334, NCP335

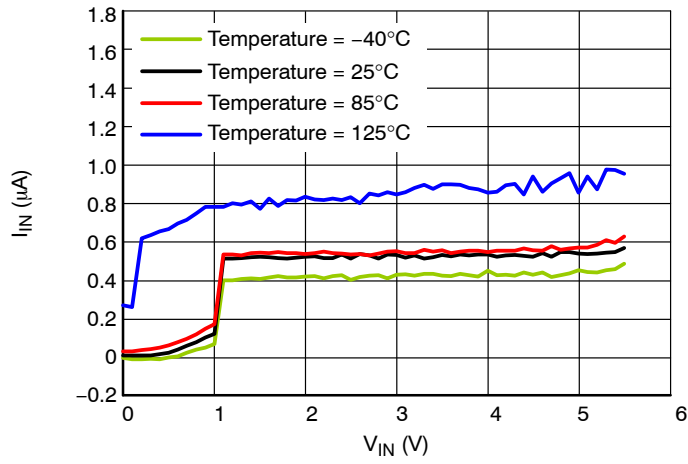

Figure 10. Quiescent Current ( $\mu\text{A}$ ) versus  $V_{\text{IN}}$  (V), No load.

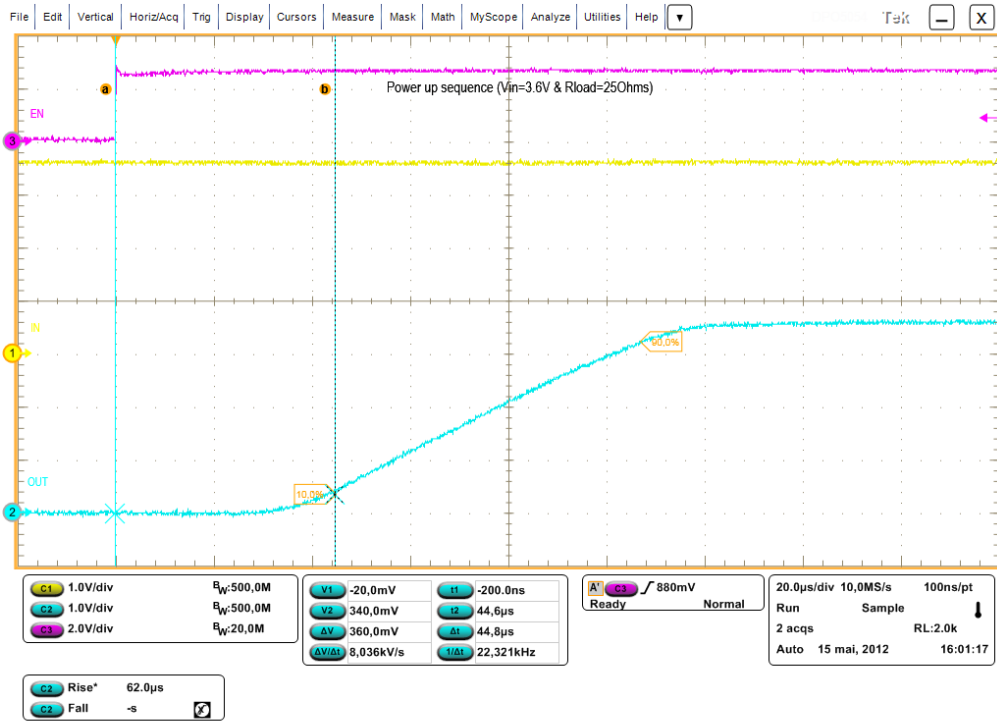

Figure 11. Enable Time, Rise Time, and Ton Time

# NCP334, NCP335

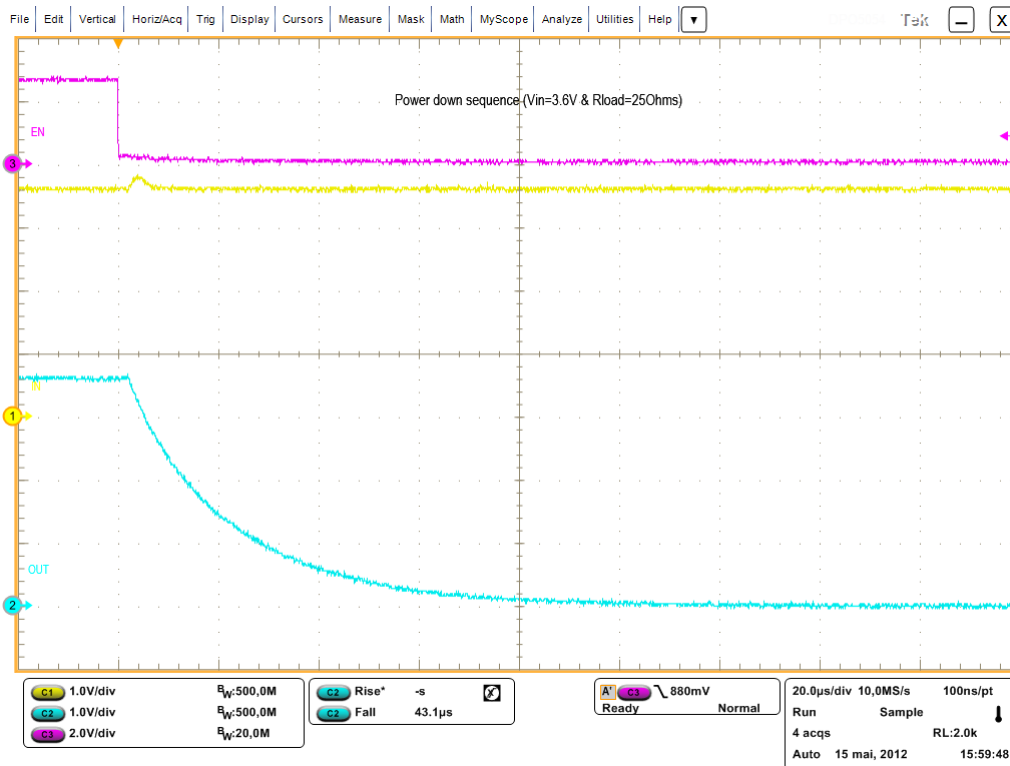

Figure 12. Disable Time, Fall Time and Toff Time

## FUNCTIONAL DESCRIPTION

### Overview

The NCP334 – NCP335 are high side P channel MOSFET power distribution switch designed to isolate ICs connected on the battery in order to save energy. The part can be turned on, with a range of battery from 1.2 V to 5.5 V.

### Enable Input

Enable pin is an active high. The path is opened when EN pin is tied low (disable), forcing P MOS switch off.

The IN/OUT path is activated with a minimum of  $V_{in}$  of 1.2V and EN forced to high level.

### Auto Discharge (NCP335 Only)

NMOS FET is placed between the output pin and GND, in order to discharge the application capacitor connected on OUT pin.

The auto-discharge is activated when EN pin is set to low level (disable state).

The discharge path ( Pull down NMOS) stays activated as long as EN pin is set at low level and  $V_{IN} > 1.2$  V.

In order to limit the current across the internal discharge N-MOSFET, the typical value is set at 65  $\Omega$ .

### Cin and Cout Capacitors

IN and OUT, 1  $\mu$ F, at least, capacitors must be placed as close as possible the part for stability improvement.

# NCP334, NCP335

## APPLICATION INFORMATION

### Power Dissipation

Main contributor in term of junction temperature is the power dissipation of the power MOSFET. Assuming this, the power dissipation and the junction temperature in normal mode can be calculated with the following equations:

$$P_D = R_{DS(on)} \times (I_{OUT})^2$$

$P_D$  = Power dissipation (W)

$R_{DS(on)}$  = Power MOSFET on resistance ( $\Omega$ )

$I_{OUT}$  = Output current (A)

$$T_J = P_D \times R_{\theta JA} + T_A$$

$T_J$  = Junction temperature ( $^{\circ}\text{C}$ )  
 $R_{\theta JA}$  = Package thermal resistance ( $^{\circ}\text{C}/\text{W}$ )  
 $T_A$  = Ambient temperature ( $^{\circ}\text{C}$ )

### PCB Recommendations

The NCP334 – NCP335 integrate an up to 2 A rated PMOS FET, and the PCB design rules must be respected to properly evacuate the heat out of the silicon. By increasing PCB area, especially around IN and OUT pins, the  $R_{\theta JA}$  of the package can be decreased, allowing higher power dissipation.

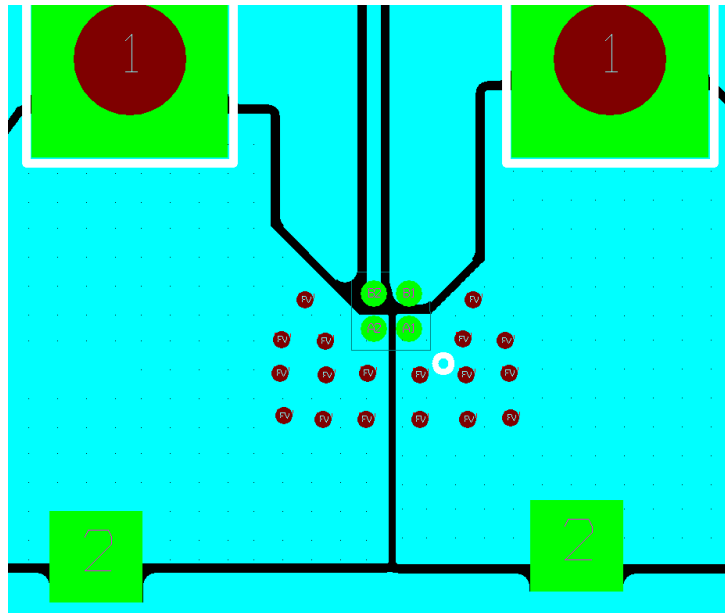

Figure 13. Routing Example 1 oz, 2 Layers, 100°C/W



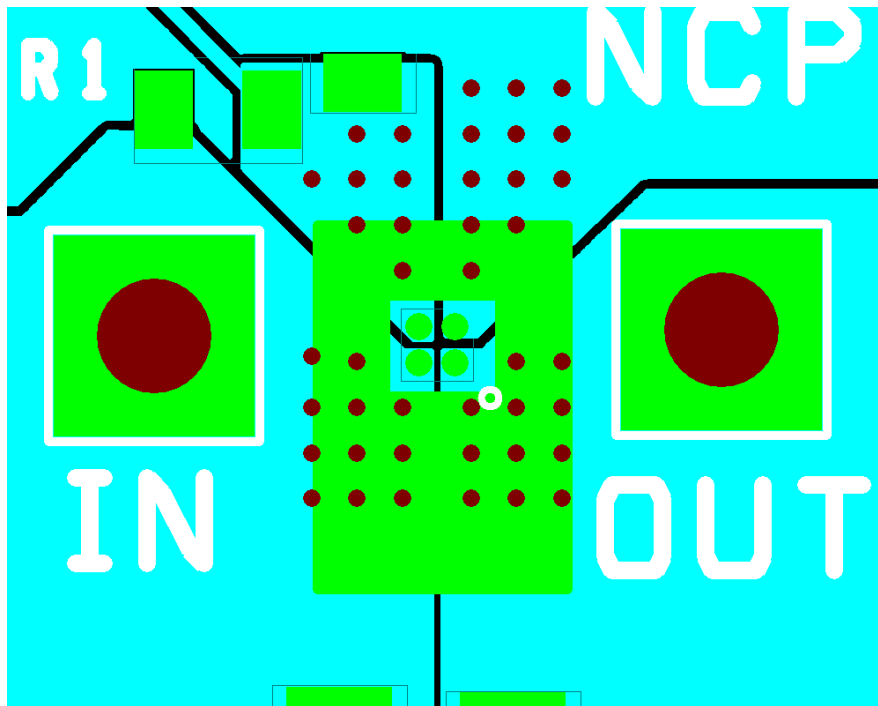

Figure 14. Routing Example 2 oz, 4 Layers, 60°C/W

Example of application definition.

$$T_J - T_A = R_{\theta JA} \times Pd = R_{\theta JA} \times R_{DS(on)} \times I^2$$

$T_J$ : Junction Temperature.

$T_A$ : Ambient Temperature.

$R_{\theta}$  = Thermal resistance between IC and air, through PCB.

$R_{DS(on)}$ : Intrinsic resistance of the IC MOSFET.

I: load DC current.

Taking into account of  $R_{\theta}$  obtain with:

1 oz, 2 layers: 100°C/W.

At 2 A, 25°C ambient temperature,  $R_{DS(on)}$  42 mΩ @  $V_{IN}$  4.2 V, the junction temperature will be:

$$T_J = T_A + R_{\theta} \times Pd = 25 + (0.042 \times 2^2) \times 100 = 41.8^\circ\text{C/W}$$

Taking into account of  $R_{\theta}$  obtain with:

2 oz, 4 layers: 60°C/W.

At 2 A, 25°C ambient temperature,  $R_{DS(on)}$  42 mΩ @  $V_{IN}$  4.2 V, the junction temperature will be:

$$T_J = T_A + R_{\theta} \times Pd = 25 + (0.042 \times 2^2) \times 60 = 35^\circ\text{C}.$$

#### ORDERING INFORMATION

Device	Marking	Package	Shipping†
NCP334FCT2G	AD	WLCSP 0.96 x 0.96 mm (Pb-Free)	3000 / Tape & Reel
NCP335FCT2G	AA	WLCSP 0.96 x 0.96 mm (Pb-Free)	3000 / Tape & Reel

†For information on tape and reel specifications, including part orientation and tape sizes, please refer to our Tape and Reel Packaging Specifications Brochure, BRD8011/D.

# MECHANICAL CASE OUTLINE PACKAGE DIMENSIONS

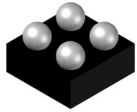

## WLCSP4 0.96x0.96x0.609 CASE 567FG ISSUE A

DATE 01 JUL 2022

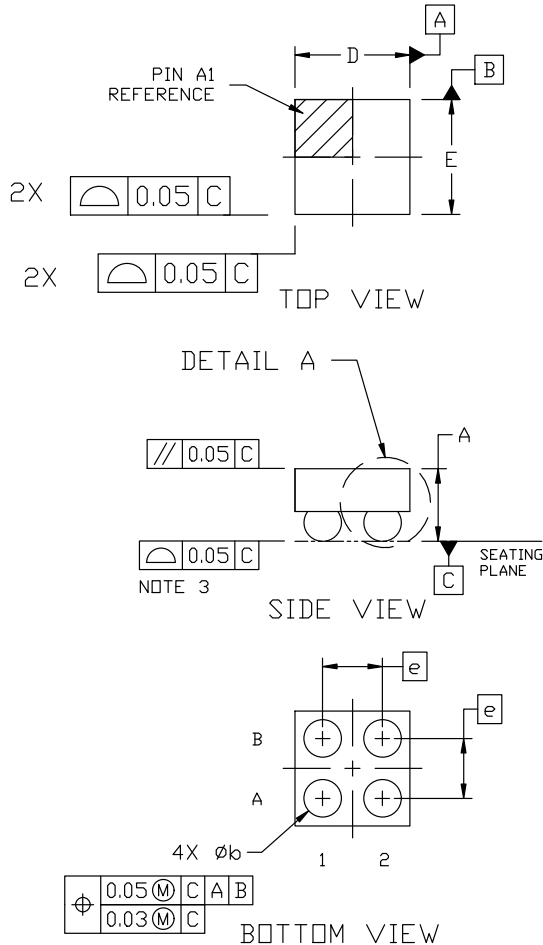

### NOTES:

1. DIMENSIONING AND TOLERANCING PER ASME Y14.5M, 1994.
2. CONTROLLING DIMENSION: MILLIMETERS
3. COPLANARITY APPLIES TO THE SPHERICAL CROWNS OF THE SOLDER BALLS.

DIM	MILLIMETERS		
	MIN.	NOM.	MAX.
A	0.554	0.609	0.664
A1	0.219	0.249	0.279
A2	0.335	0.360	0.385
b	0.282	0.312	0.342
D	0.96 BSC		
E	0.96 BSC		
e	0.50 BSC		

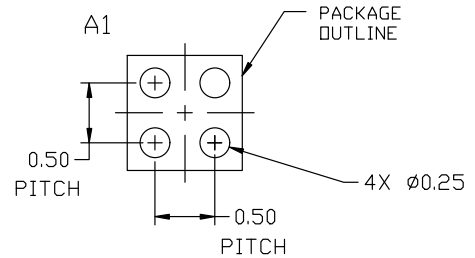
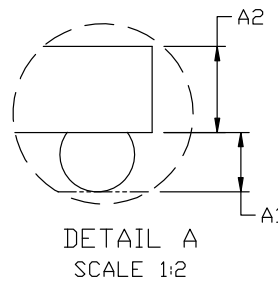

\* For additional information on our Pb-Free strategy and soldering details, please download the DN Semiconductor Soldering and Mounting Techniques Reference Manual, SOLDERRM/D.

### GENERIC MARKING DIAGRAM\*

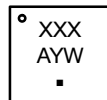

- XXX = Specific Device Code
- A = Assembly Location
- Y = Year
- W = Work Week
- = Pb-Free Package

\*This information is generic. Please refer to device data sheet for actual part marking. Pb-Free indicator, "G" or microdot "▪", may or may not be present. Some products may not follow the Generic Marking.

<b>DOCUMENT NUMBER:</b>	<b>98AON79917E</b>	Electronic versions are uncontrolled except when accessed directly from the Document Repository. Printed versions are uncontrolled except when stamped "CONTROLLED COPY" in red.
<b>DESCRIPTION:</b>	<b>WLCSP4 0.96x0.96x0.609</b>	<b>PAGE 1 OF 1</b>

onsemi and ONSEMI are trademarks of Semiconductor Components Industries, LLC dba onsemi or its subsidiaries in the United States and/or other countries. onsemi reserves the right to make changes without further notice to any products herein. onsemi makes no warranty, representation or guarantee regarding the suitability of its products for any particular purpose, nor does onsemi assume any liability arising out of the application or use of any product or circuit, and specifically disclaims any and all liability, including without limitation special, consequential or incidental damages. onsemi does not convey any license under its patent rights nor the rights of others.

**onsemi**, **Onsemi**, and other names, marks, and brands are registered and/or common law trademarks of Semiconductor Components Industries, LLC dba "**onsemi**" or its affiliates and/or subsidiaries in the United States and/or other countries. **onsemi** owns the rights to a number of patents, trademarks, copyrights, trade secrets, and other intellectual property. A listing of **onsemi**'s product/patent coverage may be accessed at [www.onsemi.com/site/pdf/Patent-Marking.pdf](http://www.onsemi.com/site/pdf/Patent-Marking.pdf). **onsemi** reserves the right to make changes at any time to any products or information herein, without notice. The information herein is provided "as-is" and **onsemi** makes no warranty, representation or guarantee regarding the accuracy of the information, product features, availability, functionality, or suitability of its products for any particular purpose, nor does **onsemi** assume any liability arising out of the application or use of any product or circuit, and specifically disclaims any and all liability, including without limitation special, consequential or incidental damages. Buyer is responsible for its products and applications using **onsemi** products, including compliance with all laws, regulations and safety requirements or standards, regardless of any support or applications information provided by **onsemi**. "Typical" parameters which may be provided in **onsemi** data sheets and/or specifications can and do vary in different applications and actual performance may vary over time. All operating parameters, including "Typicals" must be validated for each customer application by customer's technical experts. **onsemi** does not convey any license under any of its intellectual property rights nor the rights of others. **onsemi** products are not designed, intended, or authorized for use as a critical component in life support systems or any FDA Class 3 medical devices or medical devices with a same or similar classification in a foreign jurisdiction or any devices intended for implantation in the human body. Should Buyer purchase or use **onsemi** products for any such unintended or unauthorized application, Buyer shall indemnify and hold **onsemi** and its officers, employees, subsidiaries, affiliates, and distributors harmless against all claims, costs, damages, and expenses, and reasonable attorney fees arising out of, directly or indirectly, any claim of personal injury or death associated with such unintended or unauthorized use, even if such claim alleges that **onsemi** was negligent regarding the design or manufacture of the part. **onsemi** is an Equal Opportunity/Affirmative Action Employer. This literature is subject to all applicable copyright laws and is not for resale in any manner.

## PUBLICATION ORDERING INFORMATION

### LITERATURE FULFILLMENT:

Email Requests to: [orderlit@onsemi.com](mailto:orderlit@onsemi.com)

**onsemi Website:** [www.onsemi.com](http://www.onsemi.com)

### TECHNICAL SUPPORT

**North American Technical Support:**

Voice Mail: 1 800-282-9855 Toll Free USA/Canada

Phone: 011 421 33 790 2910

**Europe, Middle East and Africa Technical Support:**

Phone: 00421 33 790 2910

For additional information, please contact your local Sales Representative