

Ceramic

# Low Pass Filter

LFCW-1142+

50Ω

DC to 11.4 GHz

## The Big Deal

- Small size 0603 (1.6 x 0.8 mm)
- Low insertion loss, 2.2 dB typical
- Rejection 20 dB typical from 12.7 to 16.8 GHz
- Good power handling, 6.3W



CASE STYLE: JC0603C-1

## Product Overview

Mini-Circuits' LFCW-1142+ is a Low Temperature Co-fired Ceramic (LTCC) low pass filter, designed in a very small, 0603 package. The multilayer construction provides high repeatability of performance. Small, wrap-around terminations minimize variations in performance due to parasitics. Covering DC – 11.4 GHz, these units offer low insertion loss, good rejection, and excellent power handling capability.

## Key Features

Feature	Advantages
Small size 0603 (1.6 x 0.8 mm)	Allows for high layout density of circuit boards while minimizing the effects of parasitics.
Stop band rejection 20 dB typical over 12.7 –16.8 GHz	Provides good rejection in a tiny package, saving PCB space for customers.
Wrap-around terminations	Provides excellent solderability and easy visual inspection.
LTCC construction	Rugged package, well-suited for tough environments including high humidity and high temperature extremes.

### Notes

- A. Performance and quality attributes and conditions not expressly stated in this specification document are intended to be excluded and do not form a part of this specification document.  
B. Electrical specifications and performance data contained in this specification document are based on Mini-Circuit's applicable established test performance criteria and measurement instructions.  
C. The parts covered by this specification document are subject to Mini-Circuits standard limited warranty and terms and conditions (collectively, "Standard Terms"); Purchasers of this part are entitled to the rights and benefits contained therein. For a full statement of the Standard Terms and the exclusive rights and remedies thereunder, please visit Mini-Circuits' website at [www.minicircuits.com/MCLStore/terms.jsp](http://www.minicircuits.com/MCLStore/terms.jsp)



# Ceramic Low Pass Filter

## LFCW-1142+

50Ω DC<sup>1</sup> to 11.4 GHz



Generic photo used for illustration purposes only

CASE STYLE: JC0603C-1

### Features

- Good power handling, 6.3W
- Small size 0603 (1.6 x 0.8 mm)
- 7 sections
- Temperature stable
- LTCC construction

### +RoHS Compliant

The +Suffix identifies RoHS Compliance. See our web site for RoHS Compliance methodologies and qualifications

### Applications

- Harmonic Rejection
- VHF/UHF transmitters / receivers
- lab use

### Electrical Specifications<sup>1,2</sup> at 25°C

Parameter	F#	Frequency (GHz)	Min.	Typ.	Max.	Unit
Pass Band	Insertion Loss	DC - F1	DC - 11.4	—	2.6	dB
	Freq. cut-off	F2	11.7	3.0	—	dB
	VSWR	DC - F1	DC - 11.4	—	1.85	:1
Stop Band	Rejection Loss	F3	12.7	—	20	dB
		F4 - F5	12.86 - 13.86	23	28.5	:1
		F6	16.8	—	20	dB

1. In Application where DC voltage is present at either input or output port, coupling capacitors are required.
2. Measured on Mini-Circuits Characterization Test Board TB-720+

### Functional Schematic

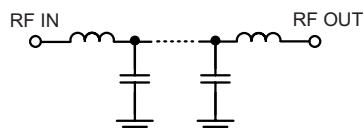

### Maximum Ratings

Operating Temperature	-55°C to 100°C
Storage Temperature	-55°C to 100°C
RF Power Input <sup>3</sup>	6.3W at 25°C

3. Passband rating, derate linearly to 3.2W at 100°C ambient ([Reference AN-75-005](#))
- Permanent damage may occur if any of these limits are exceeded.

### Typical Frequency Response

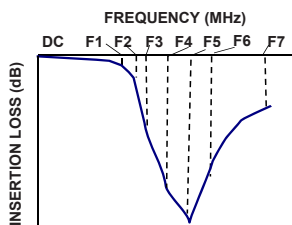

### Typical Performance Data at 25°C

Frequency (MHz)	Insertion Loss (dB)	VSWR (:1)
0.01	0.02	1.02
0.50	0.13	1.06
1.00	0.17	1.12
3.00	0.33	1.30
5.00	0.39	1.23
7.00	0.44	1.09
9.00	0.66	1.15
10.00	0.95	1.34
11.40	1.90	1.49
11.70	2.49	1.57
12.70	25.16	8.57
12.86	36.87	10.65
13.86	42.42	21.84
15.21	35.60	36.45
16.80	23.97	38.76
18.00	19.40	34.10
20.00	15.10	27.70

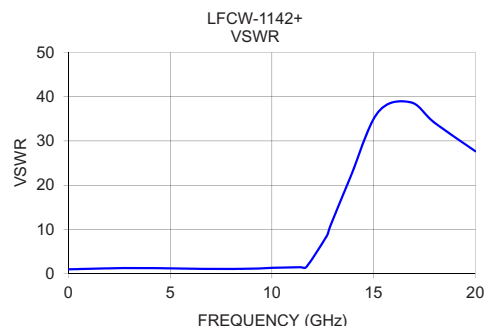
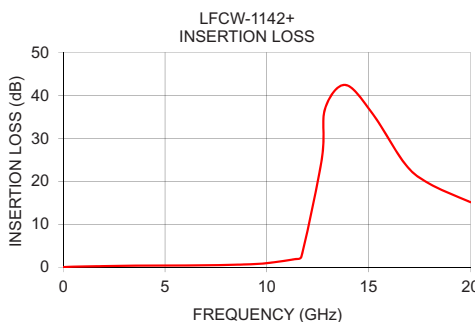

### Notes

- Performance and quality attributes and conditions not expressly stated in this specification document are intended to be excluded and do not form a part of this specification document.
- Electrical specifications and performance data contained in this specification document are based on Mini-Circuit's applicable established test performance criteria and measurement instructions.
- The parts covered by this specification document are subject to Mini-Circuits standard limited warranty and terms and conditions (collectively, "Standard Terms"); Purchasers of this part are entitled to the rights and benefits contained therein. For a full statement of the Standard Terms and the exclusive rights and remedies thereunder, please visit Mini-Circuits' website at [www.minicircuits.com/MCLStore/terms.jsp](http://www.minicircuits.com/MCLStore/terms.jsp)



[www.minicircuits.com](http://www.minicircuits.com) P.O. Box 350166, Brooklyn, NY 11235-0003 (718) 934-4500 [sales@minicircuits.com](mailto:sales@minicircuits.com)

REV. B  
M151107  
ED-15030/1  
LFCW-1142+  
MY/CP/AM  
201201  
Page 2 of 3

## Pad Connections

INPUT	1
OUTPUT	3
GROUND	2,4

Product Marking: N/A

Evaluation Board MCL P/N: TB-LFCW-1142+  
Suggested PCB Layout (PL-412)

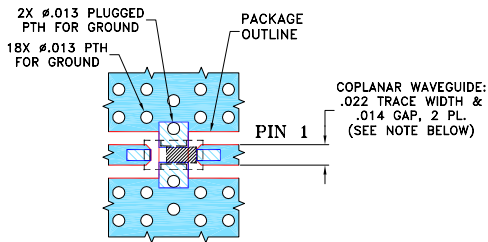

### NOTES:

- TRACE WIDTH IS SHOWN FOR ROGERS R04350B WITH DIELECTRIC THICKNESS .010" ± .001"; COPPER: 1/2 OZ. EACH SIDE. FOR OTHER MATERIALS TRACE WIDTH AND GAP MAY NEED TO BE MODIFIED.
- BOTTOM SIDE OF THE PCB IS CONTINUOUS GROUND PLANE.

 DENOTES PCB COPPER LAYOUT WITH SMOBC (SOLDER MASK OVER BARE COPPER).

 DENOTES COPPER LAND PATTERN FREE OF SOLDER MASK.

## Outline Drawing

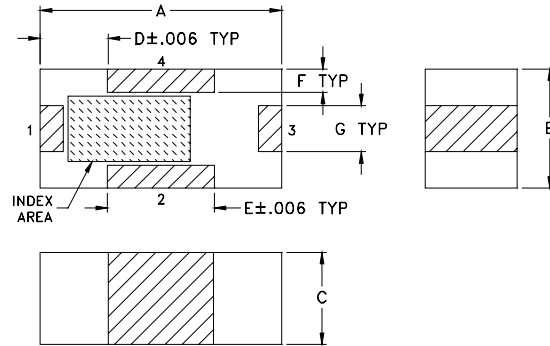

### Outline Dimensions (inch/mm)

A	B	C	D	E	F	G	wt
.063	.031	.024	.018	.028	.006	.012	grams
1.60	0.79	0.61	0.46	0.71	0.15	0.30	0.005

### Notes

- Performance and quality attributes and conditions not expressly stated in this specification document are intended to be excluded and do not form a part of this specification document.
- Electrical specifications and performance data contained in this specification document are based on Mini-Circuit's applicable established test performance criteria and measurement instructions.
- The parts covered by this specification document are subject to Mini-Circuits standard limited warranty and terms and conditions (collectively, "Standard Terms"); Purchasers of this part are entitled to the rights and benefits contained therein. For a full statement of the Standard Terms and the exclusive rights and remedies thereunder, please visit Mini-Circuits' website at [www.minicircuits.com/MCLStore/terms.jsp](http://www.minicircuits.com/MCLStore/terms.jsp)