

## SINGLE SUPPLY QUAD COMPARATOR

### ■ GENERAL DESCRIPTION

The NJM12901 is single-supply quad voltage comparator, which can operate from 2V supply. The features are low input offset voltage, low input bias current and low current consumption. The NJM12901 compare the input signal to 0V (ground) due to the Darlington PNP input stage.

The package lineup is DMP and others compact, so that the NJM12901 is suitable for any kind of signal comparator.

### ■ PACKAGE OUTLINE

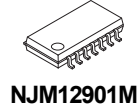

### ■ FEATURES

- Operating Voltage           ( +2V ~ +14V )
- Open Collector Output
- Bipolar Technology
- Package Outline             DMP14, SSOP14

### ■ PIN CONFIGURATION

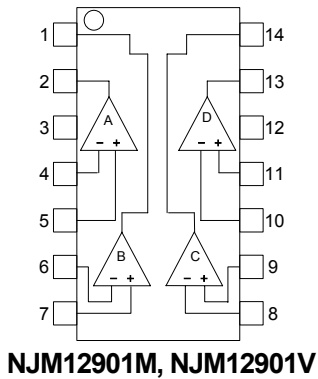

#### PIN FUNCTION

- |                   |               |
|-------------------|---------------|
| 1. B OUTPUT       | 8. C - INPUT  |
| 2. A OUTPUT       | 9. C +INPUT   |
| 3. V <sup>+</sup> | 10. D - INPUT |
| 4. A - INPUT      | 11. D +INPUT  |
| 5. A +INPUT       | 12. GND       |
| 6. B - INPUT      | 13. D OUTPUT  |
| 7. B +INPUT       | 14. C OUTPUT  |

### ■ EQUIVALENT CIRCUIT ( 1/4 Shown )

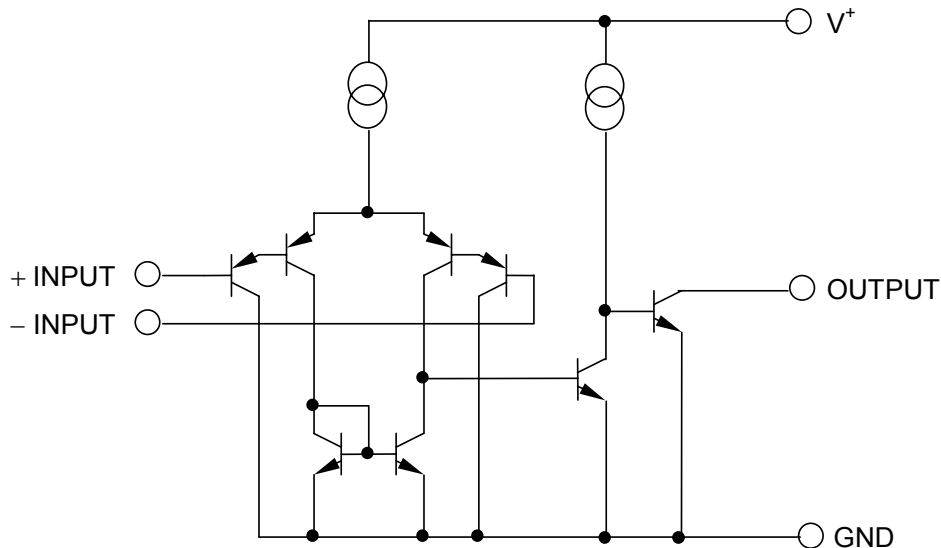

# NJM12901

## ■ ABSOLUTE MAXIMUM RATINGS( Ta=25°C )

PARAMETER	SYMBOL	RATING	UNIT
Supply Voltage	V <sup>+</sup>	15	V
Differential Input Voltage	V <sub>ID</sub>	14 (Note1)	V
Common Mode Input Voltage	V <sub>IC</sub>	-0.3~+14 (Note1)	V
Power Dissipation	P <sub>D</sub>	DMP14 300	mW
		SSOP14 300	
Operating Temperature Range	Topr	-40~+85	°C
Storage Temperature Range	Tstg	-50~+125	°C

(Note1) For supply voltage less than 14V, the maximum input voltage is equal to the supply voltage.

## ■ ELECTRICAL CHARACTERISTICS( V<sup>+</sup>=5V, Ta=25°C unless otherwise specified )

PARAMETER	SYMBOL	TEST CONDITION	MIN.	TYP.	MAX.	UNIT
Operating Voltage	V <sub>OPR</sub>		2	-	14	V
Input Offset Voltage	V <sub>IO</sub>	Rs=0Ω, Vo≈1.4V	-	1	4	mV
Input Offset Current	I <sub>IO</sub>		-	5	50	nA
Input Bias Current	I <sub>B</sub>		-	30	200	nA
Common Mode Input Voltage Range	V <sub>ICM</sub>		0~3.5	-	-	V
Large Signal Voltage Gain	A <sub>V</sub>	R <sub>L</sub> =15kΩ	-	106	-	dB
Response Time	t <sub>R</sub>	R <sub>L</sub> =5.1kΩ	-	0.5	-	μs
Output Sink Current	I <sub>SINK</sub>	V <sub>IN+</sub> =0V, V <sub>IN-</sub> =1V, Vo=1.5V	6	10	-	mA
Output Saturation Voltage	V <sub>SAT</sub>	V <sub>IN+</sub> =0V, V <sub>IN-</sub> =1V, I <sub>SINK</sub> =3mA	-	80	300	mV
Output Leakage Current	I <sub>LEAK</sub>	V <sub>IN+</sub> =0V, V <sub>IN-</sub> =1V, Vo=5V	-	0.1	1	μA
Supply Current	I <sub>CC</sub>	R <sub>L</sub> =∞	-	0.8	1.8	mA

## ■ TYPICAL CHARACTERISTICS

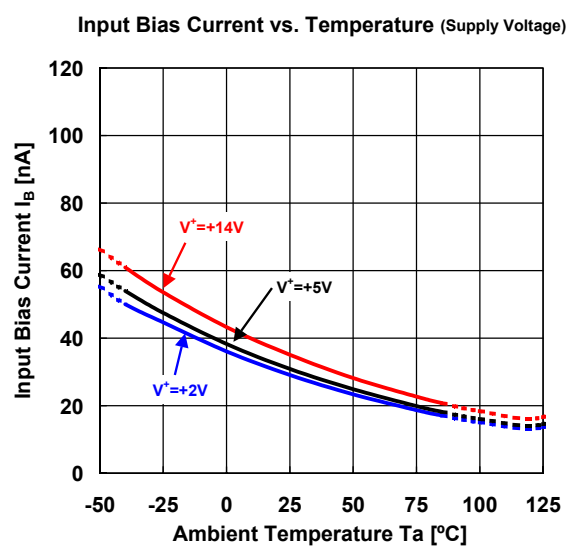
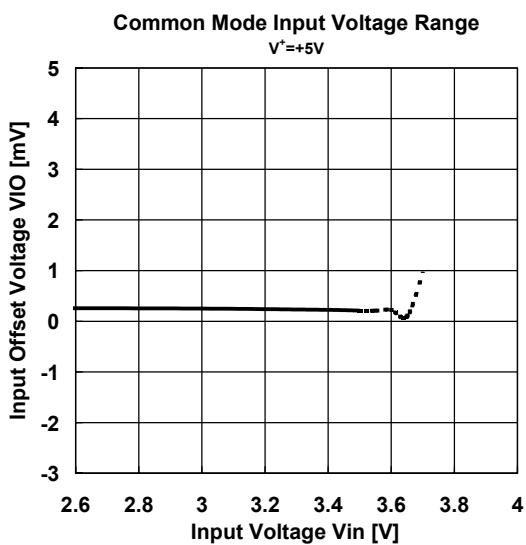
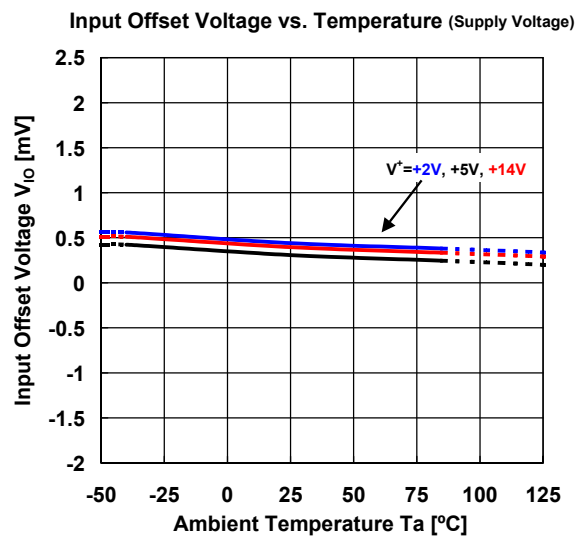
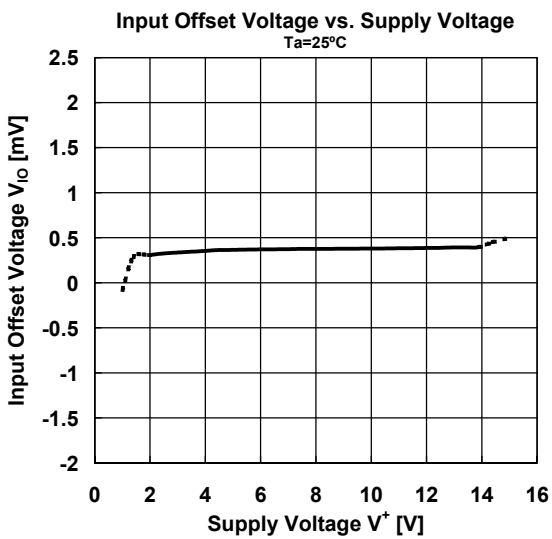
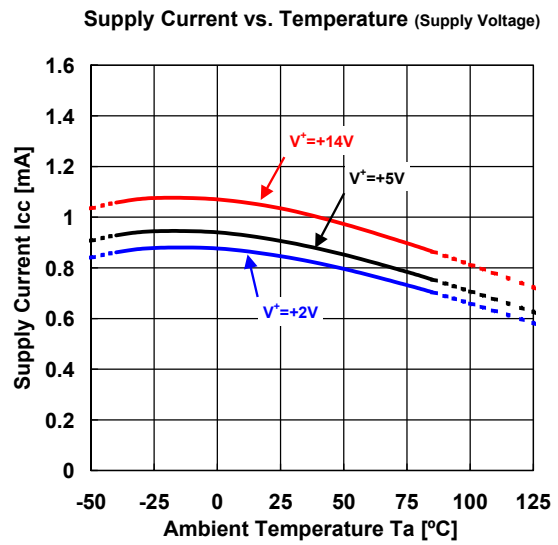
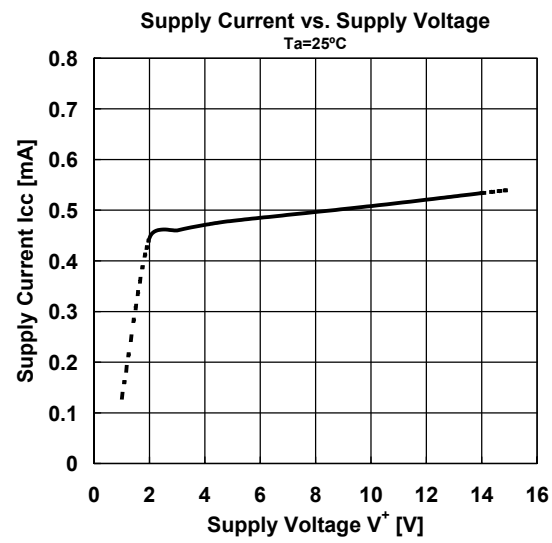

## ■ TYPICAL CHARACTERISTICS

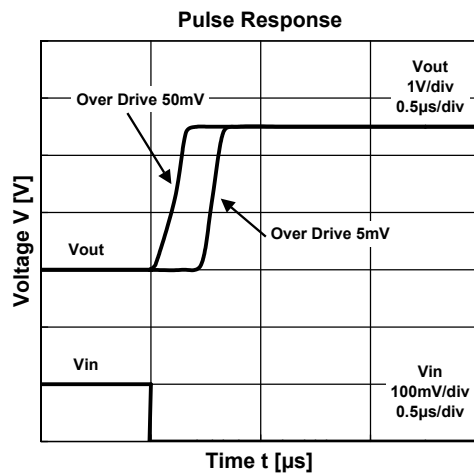
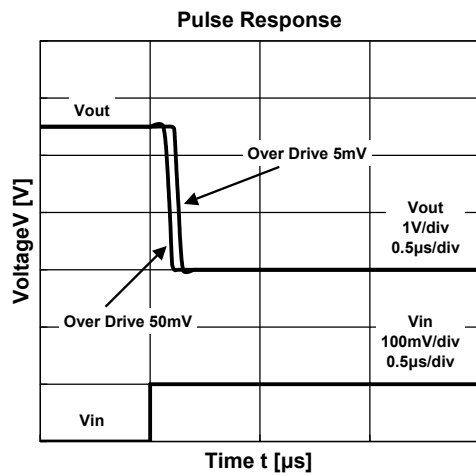
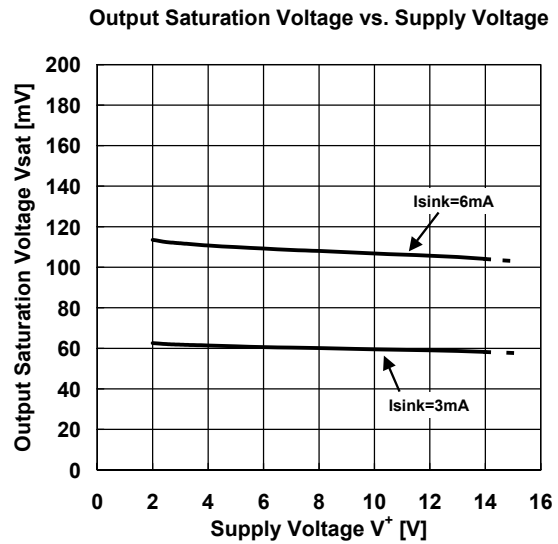
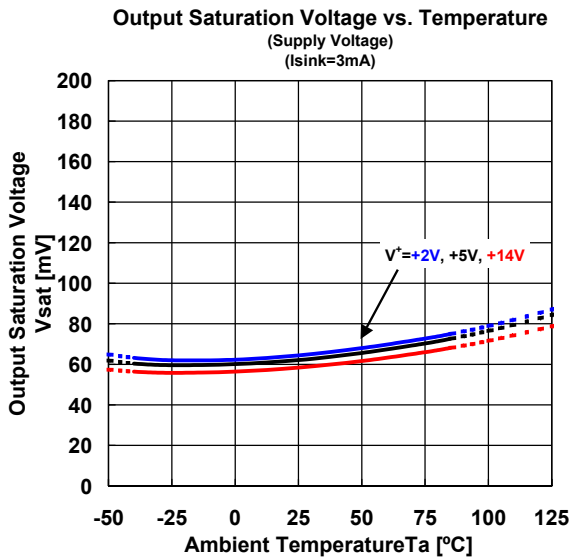
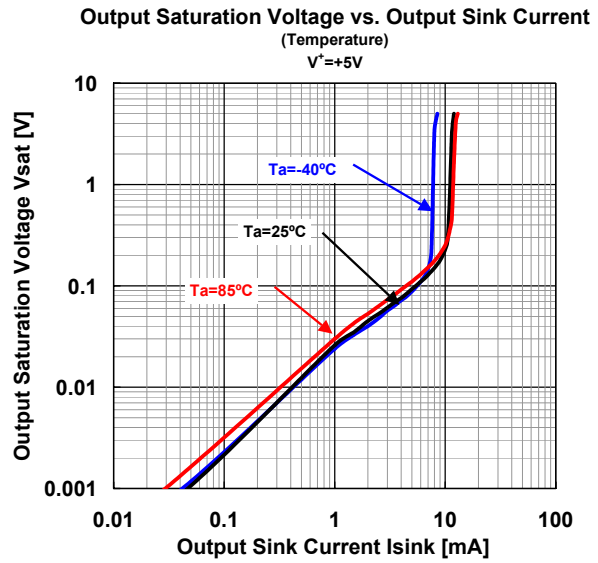
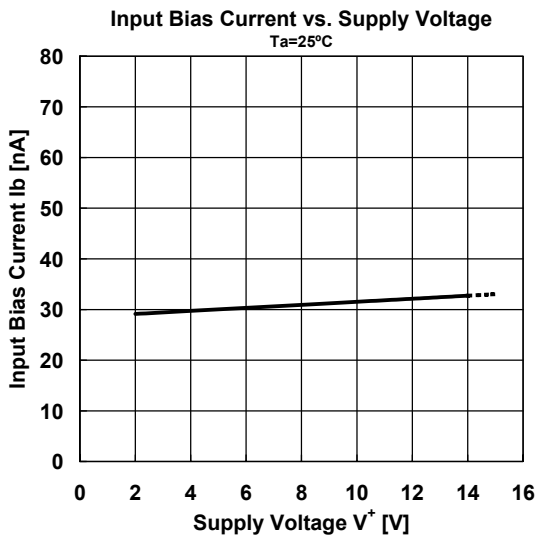

**[CAUTION]**  
 The specifications on this data book are only given for information, without any guarantee as regards either mistakes or omissions. The application circuits in this data book are described only to show representative usages of the product and not intended for the guarantee or permission of any right including the industrial rights.