



## LD2981 series

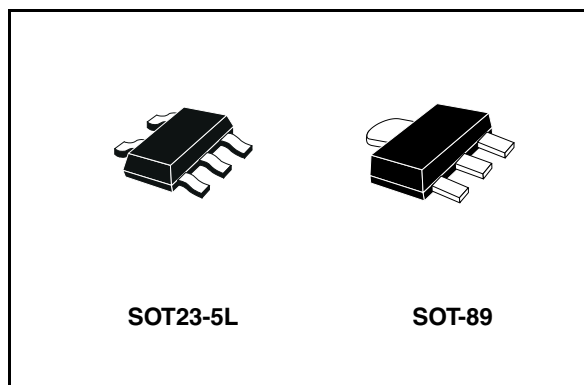
Ultra low dropout voltage regulators with inhibit  
Low ESR output capacitors compatible

### Feature summary

- Stable with low ESR ceramic capacitors
- Ultra low dropout voltage (0.17V typ. at 100mA load, 7mV typ. at 1mA load)
- Very low quiescent current (80 $\mu$ A typ. at no load in on mode; max 1 $\mu$ A in off mode)
- Guaranteed output current up to 100mA
- Logic-controlled electronic shutdown
- Output voltage of 1.5; 1.8; 2.5; 3.0; 3.3; 3.6; 3.8; 5.0V
- Internal current and thermal limit
- $\pm 0.75\%$  Tolerance output voltage available (A version)
- Output low noise voltage 160 $\mu$ V<sub>RMS</sub>
- Temperature range: -40 to 125°C
- Smallest package SOT23-5L and SOT-89
- Fast dynamic response to line and load changes

### Description

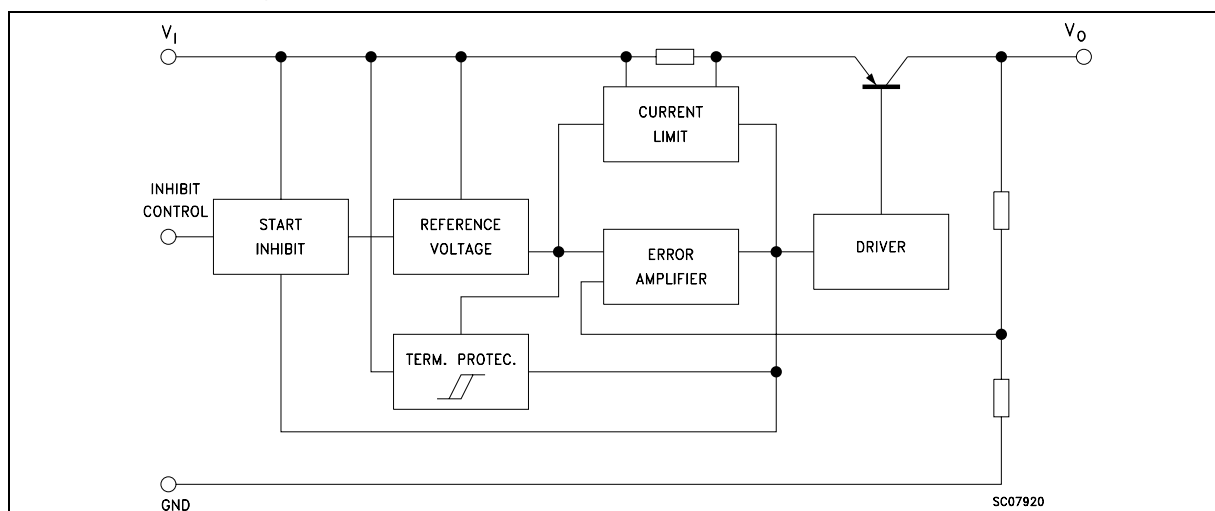
The LD2981 series are 100mA fixed-output voltage regulator. The low drop-voltage and the



ultra low quiescent current make them suitable for low noise, low power applications and in battery powered systems.

The quiescent current in sleep mode is less than 1 $\mu$ A when INHIBIT pin is pulled low. Shutdown Logic Control function is available on pin n.3 (TTL compatible). This means that when the device is used as local regulator, it is possible to put a part of the board in standby, decreasing the total power consumption. The LD2981 is designed to work with low ESR ceramic capacitor. Typical applications are in cellular phone, palmtop/laptop computer, personal digital assistant (PDA), personal stereo, camcorder and camera.

### Schematic diagram



---

## Contents

<b>1</b>	<b>Pin configuration</b> .....	<b>3</b>
<b>2</b>	<b>Maximum ratings</b> .....	<b>4</b>
<b>3</b>	<b>Typical application</b> .....	<b>5</b>
<b>4</b>	<b>Electrical characteristics</b> .....	<b>6</b>
<b>5</b>	<b>Typical performance characteristics</b> .....	<b>10</b>
<b>6</b>	<b>Application notes</b> .....	<b>13</b>
	6.1 External capacitors .....	13
	6.2 Input capacitor .....	13
	6.3 Output capacitor .....	13
	6.4 Important .....	13
	6.5 Inhibit input operation .....	13
	6.6 Reverse current .....	14
<b>7</b>	<b>Package mechanical data</b> .....	<b>15</b>
<b>8</b>	<b>Order code</b> .....	<b>20</b>
<b>9</b>	<b>Revision history</b> .....	<b>21</b>

# 1 Pin configuration

Figure 1. Pin connections (top view)

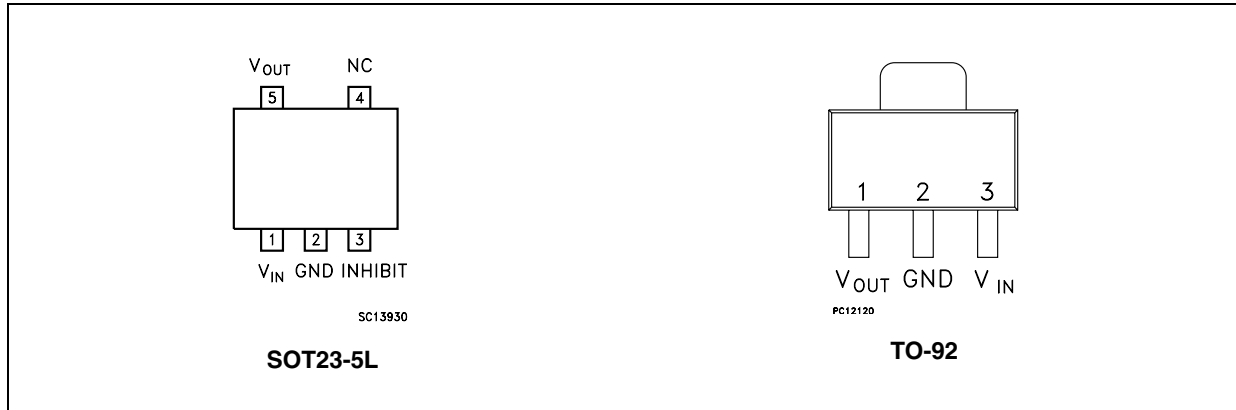


Table 1. Pin description

Pin N° SOT23-5L	Pin N° SOT-89	Symbol	Name and Function
1	3	$V_{IN}$	Input port
2	2	GND	Ground pin
3		INHIBIT	Control switch ON/OFF. Inhibit is not internally pulled-up; it cannot be left floating. Disable the device when connected to GND or to a positive voltage less than 0.18V
4		NC	Not connected
5	1	$V_{OUT}$	Output port

Table 2. Thermal data

Symbol	Parameter	SOT23-5L	SOT-89	Unit
$R_{thJC}$	Thermal resistance junction-case	81	15	°C/W
$R_{thJA}$	Thermal resistance junction-ambient	255	110	°C/W

## 2 Maximum ratings

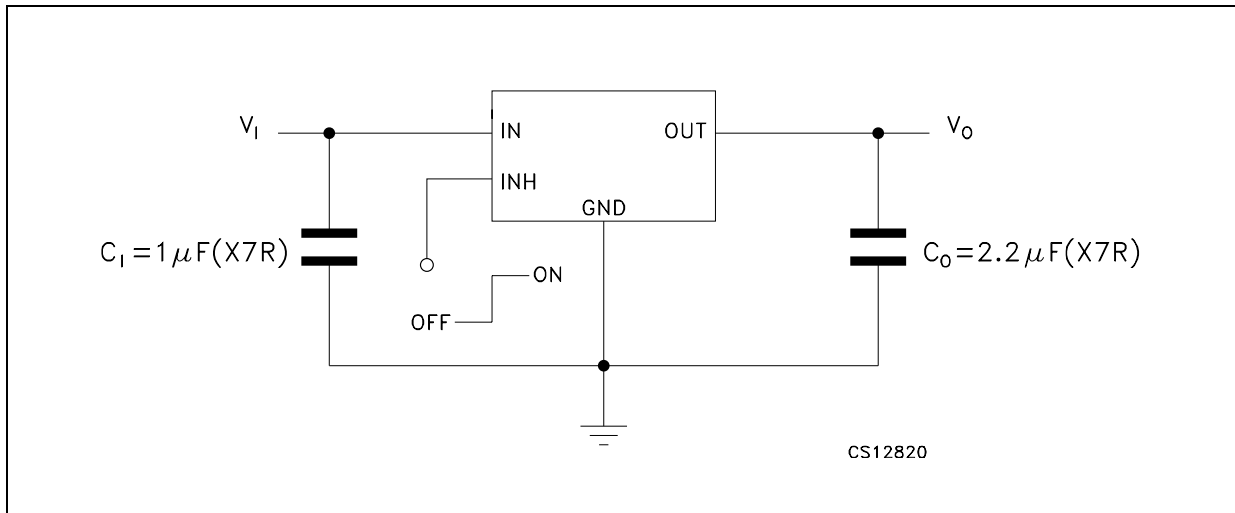
**Table 3. Absolute maximum ratings**

Symbol	Parameter	Value	Unit
$V_I$	DC Input voltage	-0.3 to 16	V
$V_{INH}$	INHIBIT Input voltage	-0.3 to 16	V
$I_O$	Output current	Internally limited	
$P_D$	Power dissipation	Internally limited	
$T_{STG}$	Storage temperature range	-55 to 150	°C
$T_{OP}$	Operating junction temperature range	-40 to 125	°C

*Note: Absolute Maximum Ratings are those values beyond which damage to the device may occur. Functional operation under these condition is not implied.*

### 3 Typical application

Figure 2. Application circuit



**Note:** *Inhibit Pin is not internally pulled-up then it must not be left floating. Disable the device when connected to GND or to a positive voltage less than 0.18V.*

## 4 Electrical characteristics

**Table 4. Electrical characteristics for LD2981AB** ( $T_J = 25^\circ\text{C}$ ,  $V_I = V_{O(\text{NOM})} + 1\text{V}$ ,  $C_I = 1\mu\text{F(X7R)}$ ,  $C_O = 2.2\mu\text{F(X7R)}$ ,  $I_O = 1\text{mA}$ ,  $V_{\text{INH}} = 2\text{V}$ , unless otherwise specified).

Symbol	Parameter	Test conditions	Min.	Typ.	Max.	Unit
$V_{\text{OP}}$	Operating input voltage		2.5		16	V
$V_O$	Output voltage	$I_O = 1\text{mA}$	2.481	2.5	2.518	V
		$I_O = 1\text{ to }100\text{mA}$	2.475		2.525	
		$I_O = 1\text{ to }100\text{mA}$ , $T_J = -40\text{ to }125^\circ\text{C}$	2.437		2.562	
$V_O$	Output voltage	$I_O = 1\text{mA}$	2.828	2.85	2.872	V
		$I_O = 1\text{ to }100\text{mA}$	2.822		2.878	
		$I_O = 1\text{ to }100\text{mA}$ , $T_J = -40\text{ to }125^\circ\text{C}$	2.779		2.921	
$V_O$	Output voltage	$I_O = 1\text{mA}$	2.977	3	3.023	V
		$I_O = 1\text{ to }100\text{mA}$	2.970		3.030	
		$I_O = 1\text{ to }100\text{mA}$ , $T_J = -40\text{ to }125^\circ\text{C}$	2.925		3.075	
$V_O$	Output voltage	$I_O = 1\text{mA}$	3.176	3.2	3.224	V
		$I_O = 1\text{ to }100\text{mA}$	3.168		3.232	
		$I_O = 1\text{ to }100\text{mA}$ , $T_J = -40\text{ to }125^\circ\text{C}$	3.12		3.28	
$V_O$	Output voltage	$I_O = 1\text{mA}$	3.275	3.3	3.325	V
		$I_O = 1\text{ to }100\text{mA}$	3.267		3.333	
		$I_O = 1\text{ to }100\text{mA}$ , $T_J = -40\text{ to }125^\circ\text{C}$	3.217		3.383	
$V_O$	Output voltage	$I_O = 1\text{mA}$	3.573	3.6	3.627	V
		$I_O = 1\text{ to }100\text{mA}$	3.564		3.636	
		$I_O = 1\text{ to }100\text{mA}$ , $T_J = -40\text{ to }125^\circ\text{C}$	3.510		3.690	
$V_O$	Output voltage	$I_O = 1\text{mA}$	3.771	3.8	3.829	V
		$I_O = 1\text{ to }100\text{mA}$	3.762		3.838	
		$I_O = 1\text{ to }100\text{mA}$ , $T_J = -40\text{ to }125^\circ\text{C}$	3.705		3.895	
$V_O$	Output voltage	$I_O = 1\text{mA}$	3.97	4	4.03	V
		$I_O = 1\text{ to }100\text{mA}$	3.96		4.04	
		$I_O = 1\text{ to }100\text{mA}$ , $T_J = -40\text{ to }125^\circ\text{C}$	3.9		4.1	
$V_O$	Output voltage	$I_O = 1\text{mA}$	4.664	4.7	4.735	V
		$I_O = 1\text{ to }100\text{mA}$	4.653		4.747	
		$I_O = 1\text{ to }100\text{mA}$ , $T_J = -40\text{ to }125^\circ\text{C}$	4.582		4.817	
$V_O$	Output voltage	$I_O = 1\text{mA}$	4.813	4.85	4.887	V
		$I_O = 1\text{ to }100\text{mA}$	4.801		4.899	
		$I_O = 1\text{ to }100\text{mA}$ , $T_J = -40\text{ to }125^\circ\text{C}$	4.729		4.971	
$V_O$	Output voltage	$I_O = 1\text{mA}$	4.962	5	5.038	V
		$I_O = 1\text{ to }100\text{mA}$	4.950		5.050	
		$I_O = 1\text{ to }100\text{mA}$ , $T_J = -40\text{ to }125^\circ\text{C}$	4.875		5.125	
$\Delta V_O$	Line regulation	$V_{O(\text{NOM})} + 1 < V_{\text{IN}} < 16\text{V}$ , $I_O = 1\text{mA}$		0.003	0.014	%V
		$T_J = -40\text{ to }125^\circ\text{C}$			0.032	

**Table 4. Electrical characteristics for LD2981AB** ( $T_J = 25^\circ\text{C}$ ,  $V_I = V_{O(\text{NOM})} + 1\text{V}$ ,  $C_I = 1\mu\text{F(X7R)}$ ,  $C_O = 2.2\mu\text{F(X7R)}$ ,  $I_O = 1\text{mA}$ ,  $V_{\text{INH}} = 2\text{V}$ , unless otherwise specified).

Symbol	Parameter	Test conditions	Min.	Typ.	Max.	Unit
$I_Q$	Quiescent current ON MODE	$I_O = 0$		80	100	$\mu\text{A}$
		$I_O = 0, T_J = -40$ to $125^\circ\text{C}$			150	
		$I_O = 1\text{mA}$		100	150	
		$I_O = 1\text{mA}, T_J = -40$ to $125^\circ\text{C}$			200	
		$I_O = 25\text{mA}$		250	400	
		$I_O = 25\text{mA}, T_J = -40$ to $125^\circ\text{C}$			800	
		$I_O = 100\text{mA}$		1000	1300	
		$I_O = 100\text{mA}, T_J = -40$ to $125^\circ\text{C}$			2600	
	OFF MODE	$V_{\text{INH}} < 0.3\text{V}$				0.8
		$V_{\text{INH}} < 0.15\text{V}, T_J = -40$ to $125^\circ\text{C}$				2
$V_{\text{DROP}}$	Dropout voltage ( <i>Note: 1</i> )	$I_O = 0$		1	3	$\text{mV}$
		$I_O = 0, T_J = -40$ to $125^\circ\text{C}$			5	
		$I_O = 1\text{mA}$		7	10	
		$I_O = 1\text{mA}, T_J = -40$ to $125^\circ\text{C}$			15	
		$I_O = 25\text{mA}$		70	100	
		$I_O = 25\text{mA}, T_J = -40$ to $125^\circ\text{C}$			150	
		$I_O = 100\text{mA}$		180	250	
		$I_O = 100\text{mA}, T_J = -40$ to $125^\circ\text{C}$			375	
$I_{\text{SC}}$	Short circuit current	$R_L = 0$		150		$\text{mA}$
SVR	Supply voltage rejection	$C_O = 10\mu\text{F}, f = 1\text{KHz}$		63		$\text{dB}$
$V_{\text{INH}}$	Inhibit input logic low	LOW = Output OFF, $T_J = -40$ to $125^\circ\text{C}$			0.18	$\text{V}$
$V_{\text{INL}}$	Inhibit input logic high	HIGH = Output ON, $T_J = -40$ to $125^\circ\text{C}$	1.6			$\text{V}$
$I_{\text{INH}}$	Inhibit input current	$V_{\text{INH}} = 0\text{V}, T_J = -40$ to $125^\circ\text{C}$		0	-1	$\mu\text{A}$
		$V_{\text{INH}} = 5\text{V}, T_J = -40$ to $125^\circ\text{C}$		5	15	
$e_N$	Output noise voltage	$B_W = 300\text{Hz}$ to $50\text{KHz}, C_O = 10\mu\text{F}$		160		$\mu\text{V}_{\text{RMS}}$
$T_{\text{SHDN}}$	Thermal shutdown			170		$^\circ\text{C}$

Note: 1 For  $V_O < 2.5\text{V}$  dropout voltage can be calculated according to the minimum input voltage in full temperature range.

**Table 5. Electrical characteristics for LD2981C** ( $T_j = 25^\circ\text{C}$ ,  $V_I = V_{O(\text{NOM})} + 1\text{V}$ ,  $C_I = 1\mu\text{F(X7R)}$ ,  $C_O = 2.2\mu\text{F(X7R)}$ ,  $I_O = 1\text{mA}$ ,  $V_{\text{INH}} = 2\text{V}$ , unless otherwise specified)

Symbol	Parameter	Test conditions	Min.	Typ.	Max.	Unit
$V_{OP}$	Operating input voltage		2.5		16	V
$V_O$	Output voltage	$I_O = 1\text{ mA}$	1.478	1.5	1.522	V
		$I_O = 1\text{ to }100\text{ mA}$	1.470		1.530	
		$I_O = 1\text{ to }100\text{ mA}$ , $T_J = -40\text{ to }125^\circ\text{C}$	1.445		1.555	
$V_O$	Output voltage	$I_O = 1\text{ mA}$	1.777	1.8	1.822	V
		$I_O = 1\text{ to }100\text{ mA}$	1.764		1.836	
		$I_O = 1\text{ to }100\text{ mA}$ , $T_J = -40\text{ to }125^\circ\text{C}$	1.737		1.863	
$V_O$	Output voltage	$I_O = 1\text{ mA}$	2.468	2.5	2.531	V
		$I_O = 1\text{ to }100\text{ mA}$	2.45		2.55	
		$I_O = 1\text{ to }100\text{ mA}$ , $T_J = -40\text{ to }125^\circ\text{C}$	2.412		2.587	
$V_O$	Output voltage	$I_O = 1\text{ mA}$	2.814	2.85	2.885	V
		$I_O = 1\text{ to }100\text{ mA}$	2.793		2.907	
		$I_O = 1\text{ to }100\text{ mA}$ , $T_J = -40\text{ to }125^\circ\text{C}$	2.75		2.949	
$V_O$	Output voltage	$I_O = 1\text{ mA}$	2.962	3	3.037	V
		$I_O = 1\text{ to }100\text{ mA}$	2.94		3.06	
		$I_O = 1\text{ to }100\text{ mA}$ , $T_J = -40\text{ to }125^\circ\text{C}$	2.895		3.105	
$V_O$	Output voltage	$I_O = 1\text{ mA}$	3.16	3.2	3.24	V
		$I_O = 1\text{ to }100\text{ mA}$	3.136		3.264	
		$I_O = 1\text{ to }100\text{ mA}$ , $T_J = -40\text{ to }125^\circ\text{C}$	3.088		3.312	
$V_O$	Output voltage	$I_O = 1\text{ mA}$	3.258	3.3	3.341	V
		$I_O = 1\text{ to }100\text{ mA}$	3.234		3.366	
		$I_O = 1\text{ to }100\text{ mA}$ , $T_J = -40\text{ to }125^\circ\text{C}$	3.184		3.415	
$V_O$	Output voltage	$I_O = 1\text{ mA}$	3.555	3.6	3.645	V
		$I_O = 1\text{ to }100\text{ mA}$	3.528		3.672	
		$I_O = 1\text{ to }100\text{ mA}$ , $T_J = -40\text{ to }125^\circ\text{C}$	3.474		3.726	
$V_O$	Output voltage	$I_O = 1\text{ mA}$	3.752	3.8	3.847	V
		$I_O = 1\text{ to }100\text{ mA}$	3.724		3.876	
		$I_O = 1\text{ to }100\text{ mA}$ , $T_J = -40\text{ to }125^\circ\text{C}$	3.667		3.933	
$V_O$	Output voltage	$I_O = 1\text{ mA}$	3.95	4	4.05	V
		$I_O = 1\text{ to }100\text{ mA}$	3.92		4.08	
		$I_O = 1\text{ to }100\text{ mA}$ , $T_J = -40\text{ to }125^\circ\text{C}$	3.86		4.14	
$V_O$	Output voltage	$I_O = 1\text{ mA}$	4.641	4.7	4.758	V
		$I_O = 1\text{ to }100\text{ mA}$	4.606		4.794	
		$I_O = 1\text{ to }100\text{ mA}$ , $T_J = -40\text{ to }125^\circ\text{C}$	4.535		4.864	
$V_O$	Output voltage	$I_O = 1\text{ mA}$	4.789	4.85	4.91	V
		$I_O = 1\text{ to }100\text{ mA}$	4.753		4.947	
		$I_O = 1\text{ to }100\text{ mA}$ , $T_J = -40\text{ to }125^\circ\text{C}$	4.68		5.019	



**Table 5. Electrical characteristics for LD2981C** ( $T_J = 25^\circ\text{C}$ ,  $V_I = V_{O(NOM)} + 1\text{V}$ ,  $C_I = 1\mu\text{F}(X7R)$ ,  $C_O = 2.2\mu\text{F}(X7R)$ ,  $I_O = 1\text{mA}$ ,  $V_{INH} = 2\text{V}$ , unless otherwise specified)

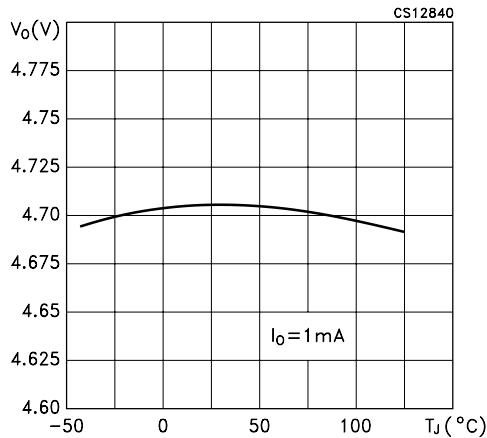
Symbol	Parameter	Test conditions	Min.	Typ.	Max.	Unit
$V_O$	Output voltage	$I_O = 1\text{ mA}$	4.937	5	5.062	V
		$I_O = 1\text{ to }100\text{ mA}$	4.9		5.1	
		$I_O = 1\text{ to }100\text{ mA}$ , $T_J = -40\text{ to }125^\circ\text{C}$	4.825		5.175	
$\Delta V_O$	Line regulation	$V_{O(NOM)} + 1 < V_{IN} < 16\text{ V}$ , $I_O = 1\text{ mA}$		0.003	0.014	%V
		$T_J = -40\text{ to }125^\circ\text{C}$			0.032	
$I_Q$	Quiescent current ON MODE	$I_O = 0$		80	100	$\mu\text{A}$
		$I_O = 0$ , $T_J = -40\text{ to }125^\circ\text{C}$			150	
		$I_O = 1\text{ mA}$		100	150	
		$I_O = 1\text{ mA}$ , $T_J = -40\text{ to }125^\circ\text{C}$			200	
		$I_O = 25\text{ mA}$		250	400	
		$I_O = 25\text{ mA}$ , $T_J = -40\text{ to }125^\circ\text{C}$			800	
		$I_O = 100\text{ mA}$		1000	1300	
		$I_O = 100\text{ mA}$ , $T_J = -40\text{ to }125^\circ\text{C}$			2600	
	OFF MODE	$V_{INH} < 0.3\text{ V}$			0.8	
		$V_{INH} < 0.15\text{ V}$ , $T_J = -40\text{ to }125^\circ\text{C}$			2	
$V_{DROP}$	Dropout voltage ( <i>Note: 1</i> )	$I_O = 0$		1	3	mV
		$I_O = 0$ , $T_J = -40\text{ to }125^\circ\text{C}$			5	
		$I_O = 1\text{ mA}$		7	10	
		$I_O = 1\text{ mA}$ , $T_J = -40\text{ to }125^\circ\text{C}$			15	
		$I_O = 25\text{ mA}$		70	100	
		$I_O = 25\text{ mA}$ , $T_J = -40\text{ to }125^\circ\text{C}$			150	
		$I_O = 100\text{ mA}$		180	250	
		$I_O = 100\text{ mA}$ , $T_J = -40\text{ to }125^\circ\text{C}$			375	
$I_{SC}$	Short circuit current	$R_L = 0$		150		mA
SVR	Supply voltage rejection	$C_O = 10\mu\text{F}$ , $f = 1\text{KHz}$		63		dB
$V_{INH}$	Inhibit input logic low	LOW = Output OFF, $T_J = -40\text{ to }125^\circ\text{C}$			0.18	V
$V_{INL}$	Inhibit input logic high	HIGH = Output ON, $T_J = -40\text{ to }125^\circ\text{C}$	1.6			V
$I_{INH}$	Inhibit input current	$V_{INH} = 0\text{V}$ , $T_J = -40\text{ to }125^\circ\text{C}$		0	-1	$\mu\text{F}$
		$V_{INH} = 5\text{V}$ , $T_J = -40\text{ to }125^\circ\text{C}$		5	15	
$e_N$	Output noise voltage	$B_W = 300\text{ Hz to }50\text{ KHz}$ , $C_O = 10\mu\text{F}$		160		$\mu\text{V}_{RMS}$
$T_{SHDN}$	Thermal shutdown			170		$^\circ\text{C}$

Note: 1 For  $V_O < 2.5\text{V}$  dropout voltage can be calculated according to the minimum input voltage in full temperature range.

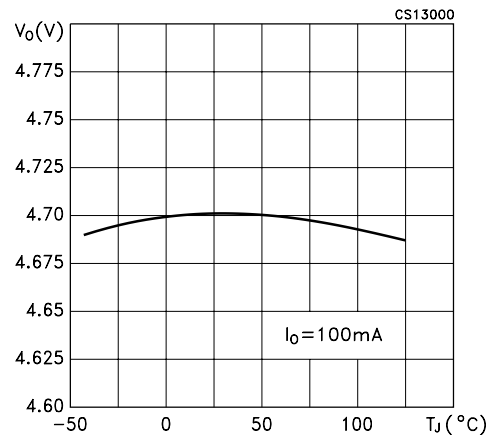
# 5 Typical performance characteristics

( $T_J = 25^\circ\text{C}$ ,  $V_I = V_{O(\text{NOM})} + 1\text{V}$ ,  $C_I = 1\mu\text{F}(\text{X7R})$ ,  $C_O = 2.2\mu\text{F}(\text{X7R})$ ,  $V_{\text{INH}} = 2\text{V}$ , unless otherwise specified).

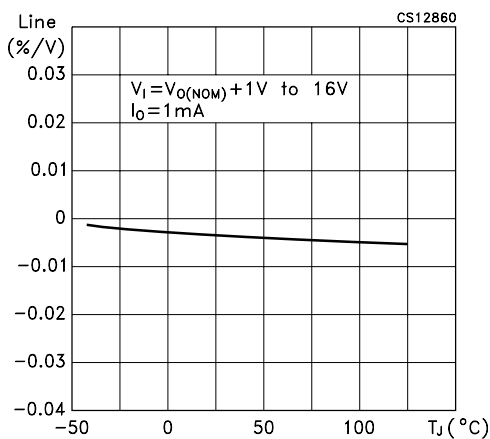
**Figure 3. Output voltage vs temperature**



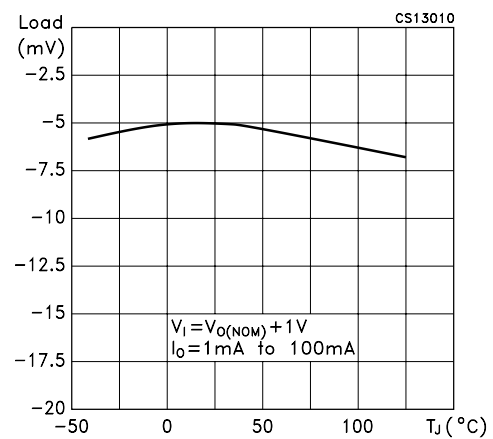
**Figure 4. Output voltage vs temperature**



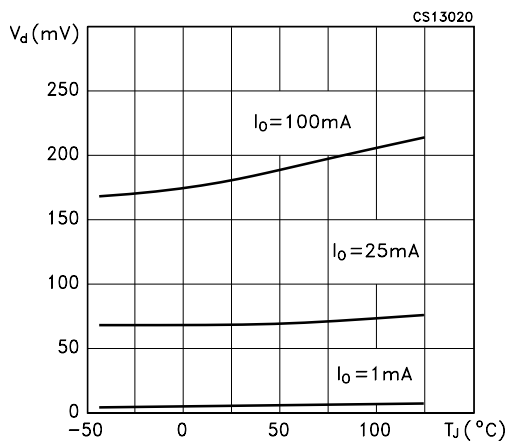
**Figure 5. Line regulation vs temperature**



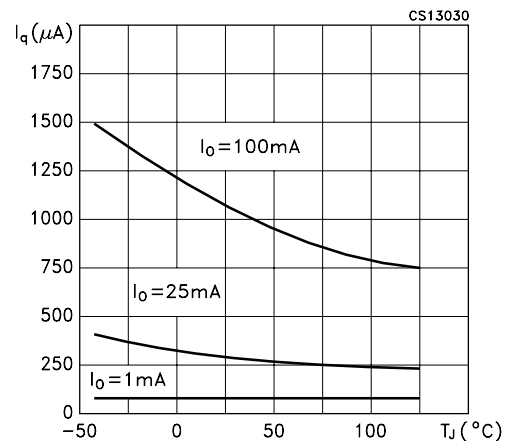
**Figure 6. Load regulation vs temperature**



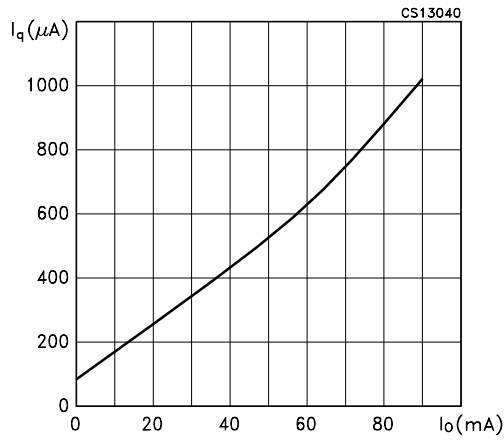
**Figure 7. Dropout voltage vs temperature**



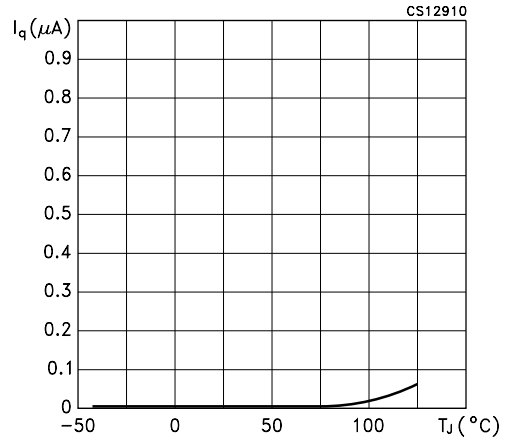
**Figure 8. Quiescent current vs temperature**



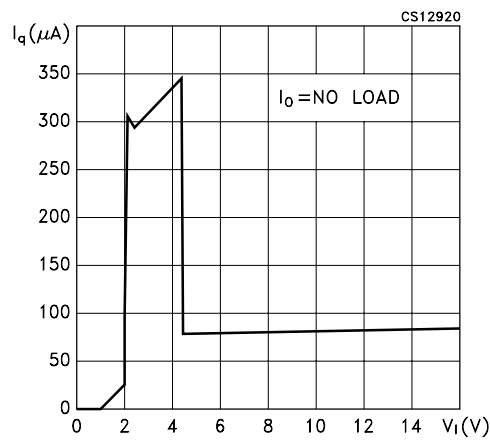
**Figure 9. Quiescent current vs output current**



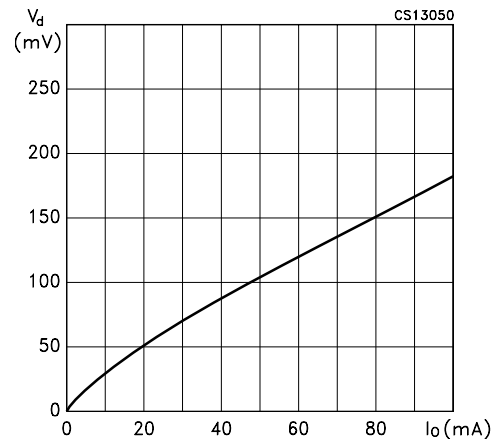
**Figure 10. Off mode quiescent current vs temperature**



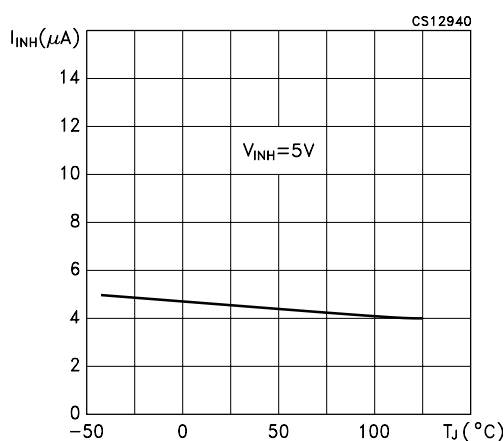
**Figure 11. Quiescent current vs input voltage**



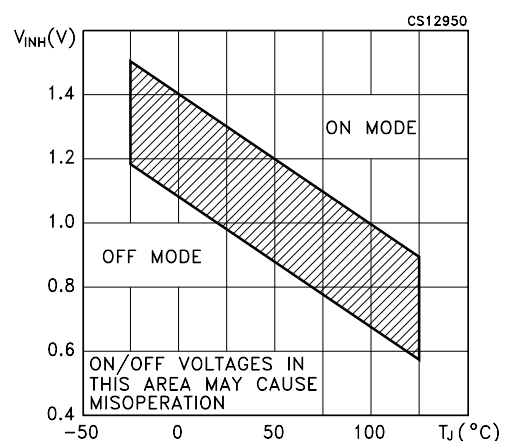
**Figure 12. Dropout voltage vs output current**



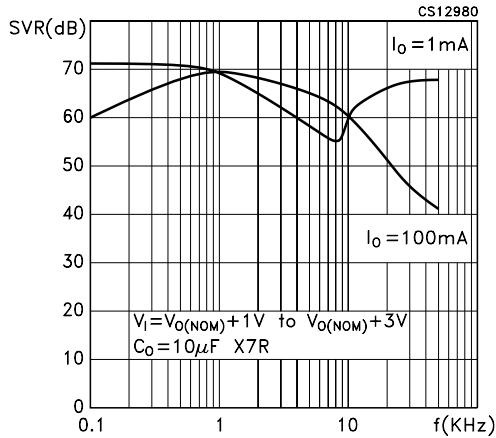
**Figure 13. Inhibit input current vs temperature**



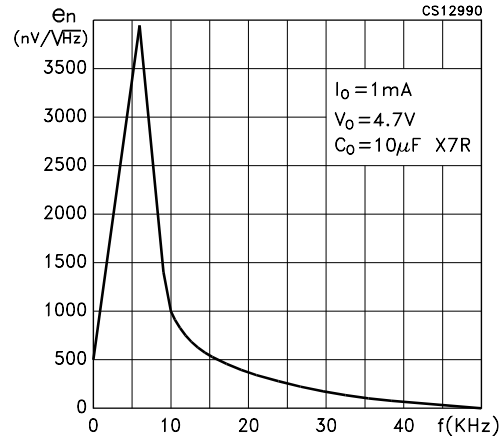
**Figure 14. Inhibit voltage vs temperature**



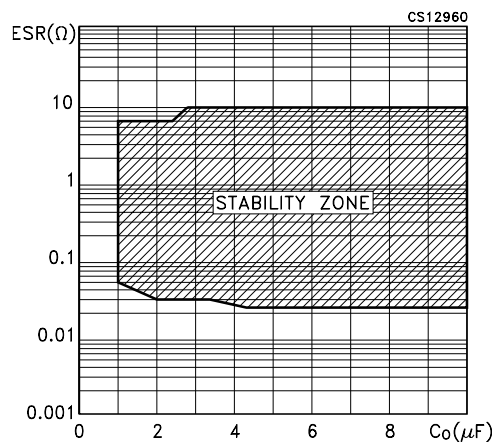
**Figure 15. Supply voltage rejection vs frequency**



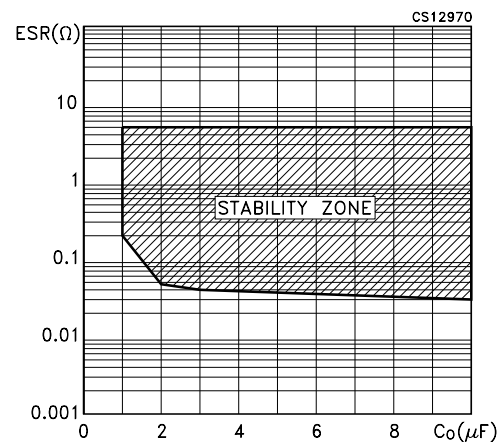
**Figure 16. Noise voltage vs frequency**



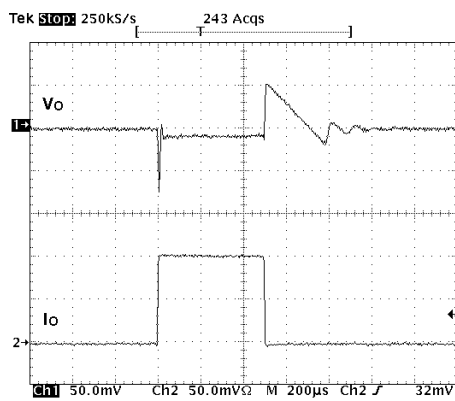
**Figure 17. Best case: highest output version**



**Figure 18. Worst case: lowest output version**

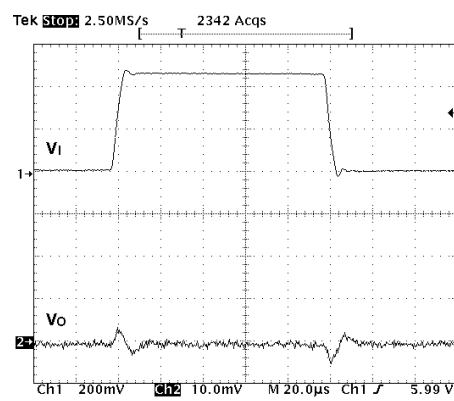


**Figure 19. Load transient response**



$V_O = 4.7V, I_O = 1 \text{ to } 100mA, C_O = 4.7\mu F (X7R)$

**Figure 20. Line transient response**



$V_I = [V_{O(NOM)} + 1V], V_O = 4.7V, I_O = 100mA, C_O = 4.7\mu F (X7R)$

## 6 Application notes

### 6.1 External capacitors

Like any low-dropout regulator, the LD2981 requires external capacitors for regulator stability. This capacitor must be selected to meet the requirements of minimum capacitance and equivalent series resistance. We suggest to solder input and output capacitors as close as possible to the relative pins.

### 6.2 Input capacitor

An input capacitor whose value is  $1\mu\text{F}$  is required with the LD2981 (amount of capacitance can be increased without limit). This capacitor must be located a distance of not more than 0.5" from the input pin of the device and returned to a clean analog ground. Any good quality ceramic, tantalum or film capacitors can be used for this capacitor.

### 6.3 Output capacitor

The LD2981 is designed specifically to work with ceramic output capacitors. It may also be possible to use Tantalum capacitors, but these are not as attractive for reasons of size and cost. By the way, the output capacitor must meet both the requirement for minimum amount of capacitance and ESR (equivalent series resistance) value. The [Figure 3](#) and [Figure 4](#) show the allowable ESR range as a function of the output capacitance. These curves represent the stability region over the full temperature and  $I_O$  range. Due to the different loop gain, the stability improves for higher output versions and so the suggested minimum output capacitor value, if low ESR ceramic type is used, is  $1\mu\text{F}$  for output voltages equal or major than 3.8V,  $2.2\mu\text{F}$  for output voltages from 2.85 to 3.3V, and  $3.3\mu\text{F}$  for the other versions. However, if an output capacitor lower than the suggested one is used, it's possible to make stable the regulator adding a resistor in series to the capacitor (see [Figure1](#) & [Figure2](#) to choose the right value according to the used version and keeping in account that the ESR of ceramic capacitors has been measured @ 100KHz).

### 6.4 Important

The output capacitor must maintain its ESR in the stable region over the full operating temperature to assure stability. Also, capacitor tolerance and variation with temperature must be considered to assure the minimum amount of capacitance is provided at all times. This capacitor should be located not more than 0.5" from the output pin of the device and returned to a clean analog ground.

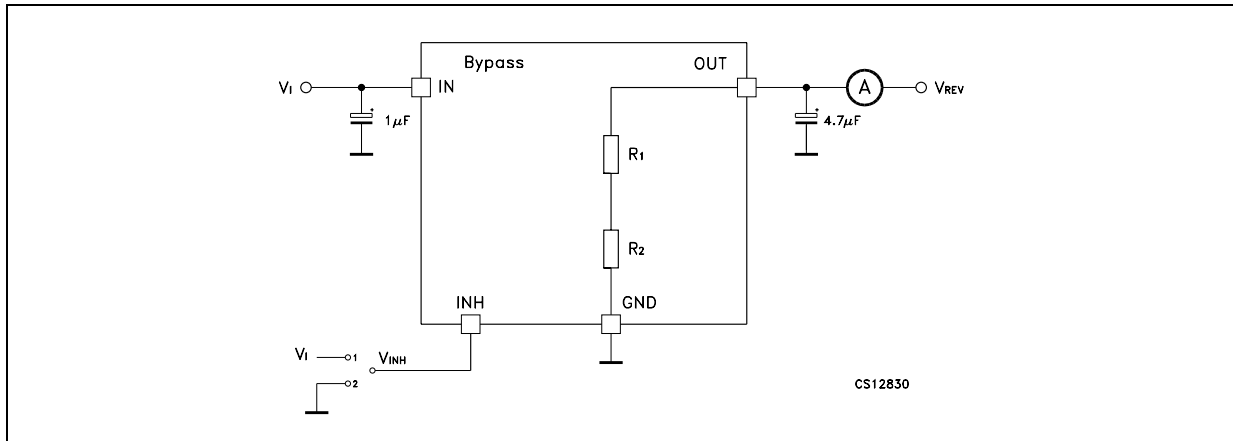
### 6.5 Inhibit input operation

The inhibit pin can be used to turn OFF the regulator when pulled low, so drastically reducing the current consumption down to less than  $1\mu\text{A}$ . When the inhibit feature is not used, this pin must be tied to  $V_I$  to keep the regulator output ON at all times. To assure proper operation, the signal source used to drive the inhibit pin must be able to swing above and below the specified thresholds listed in the electrical characteristics section under  $V_{IH}$   $V_{IL}$ . Any slew rate can be used to drive the inhibit.

## 6.6 Reverse current

The power transistor used in the LD2981 has not an inherent diode connected between the regulator input and output. If the output is forced above the input, no current will flow from the output to the input across the series pass transistor. When a  $V_{REV}$  voltage is applied on the output, the reverse current measured, according to the test circuit in [Figure 21](#)., flows to the GND across the two feedback resistors. This current typical value is  $160\mu A$ .  $R_1$  and  $R_2$  resistors are implanted type; typical values are, respectively,  $42.6 K\Omega$  and  $51.150 K\Omega$

**Figure 21. Reverse current test circuit**

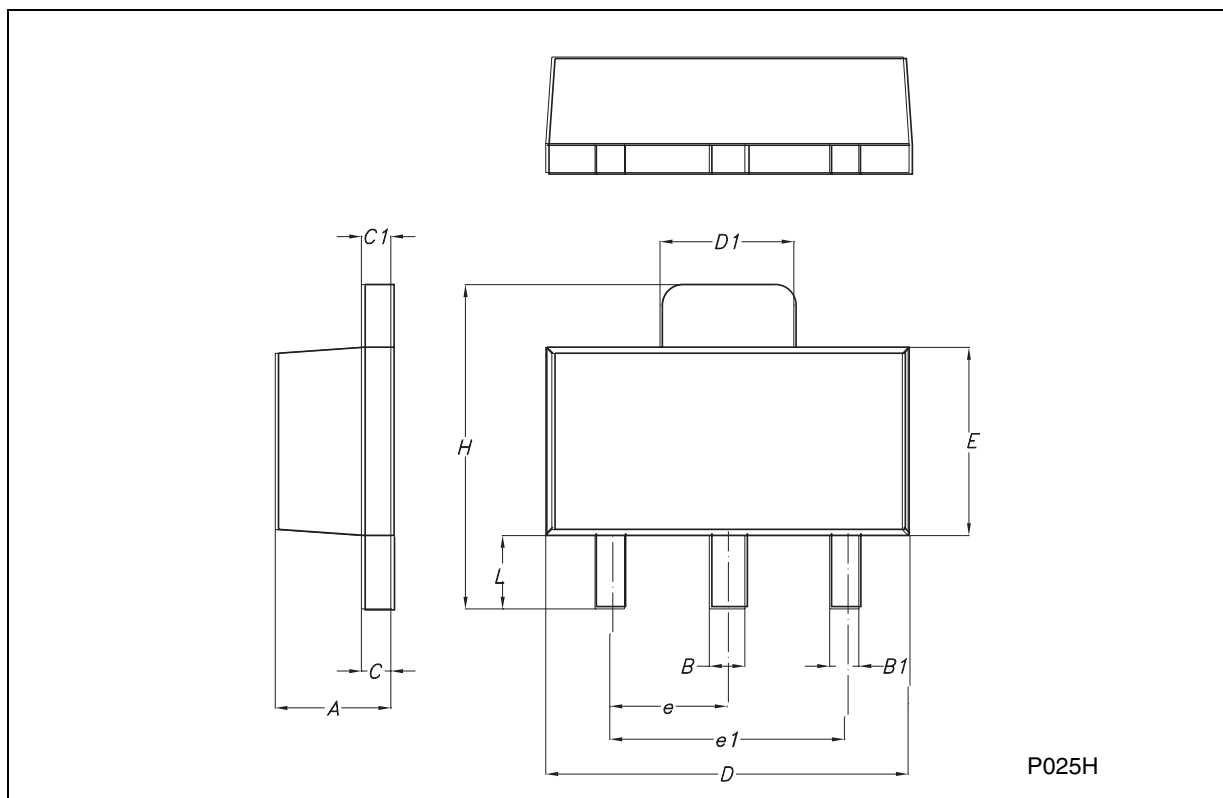


## 7 Package mechanical data

In order to meet environmental requirements, ST offers these devices in ECOPACK® packages. These packages have a Lead-free second level interconnect. The category of second Level Interconnect is marked on the package and on the inner box label, in compliance with JEDEC Standard JESD97. The maximum ratings related to soldering conditions are also marked on the inner box label. ECOPACK is an ST trademark. ECOPACK specifications are available at: [www.st.com](http://www.st.com).

**SOT-89 MECHANICAL DATA**

DIM.	mm.			mils		
	MIN.	TYP	MAX.	MIN.	TYP.	MAX.
A	1.4		1.6	55.1		63.0
B	0.44		0.56	17.3		22.0
B1	0.36		0.48	14.2		18.9
C	0.35		0.44	13.8		17.3
C1	0.35		0.44	13.8		17.3
D	4.4		4.6	173.2		181.1
D1	1.62		1.83	63.8		72.0
E	2.29		2.6	90.2		102.4
e	1.42		1.57	55.9		61.8
e1	2.92		3.07	115.0		120.9
H	3.94		4.25	155.1		167.3
L	0.89		1.2	35.0		47.2

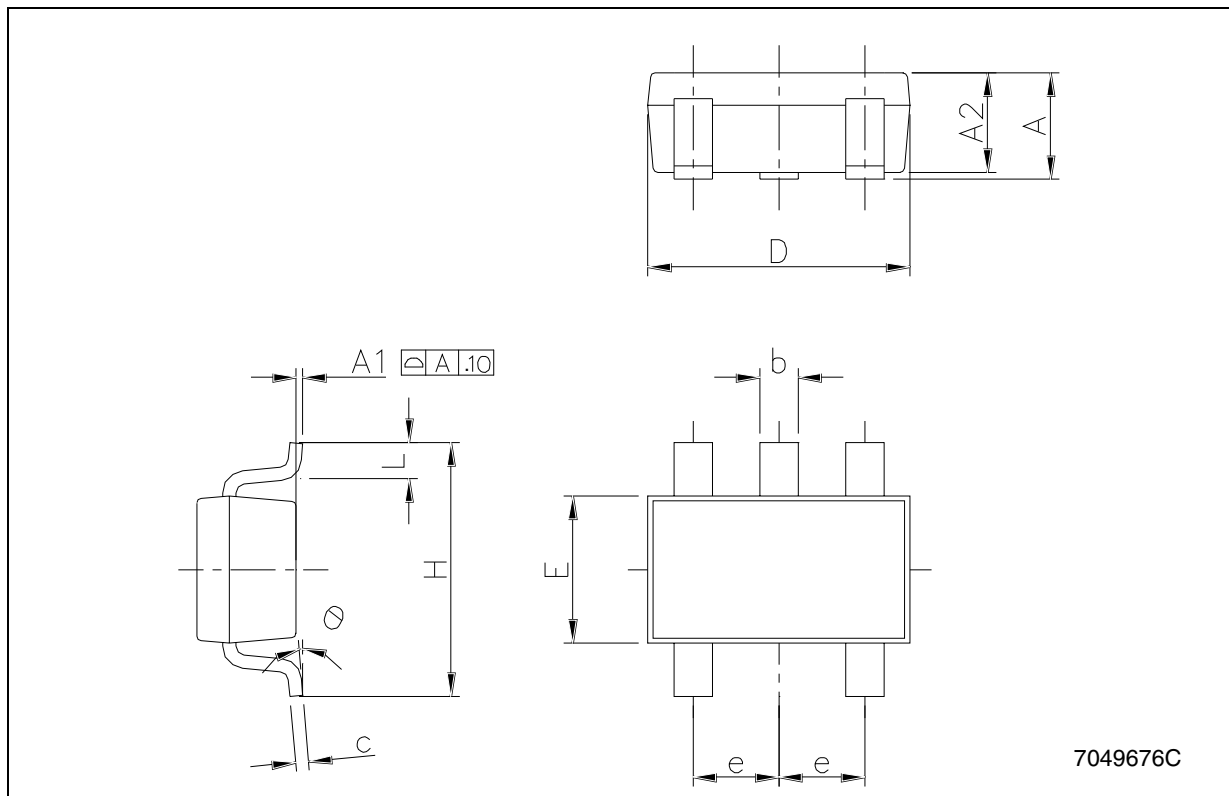


P025H



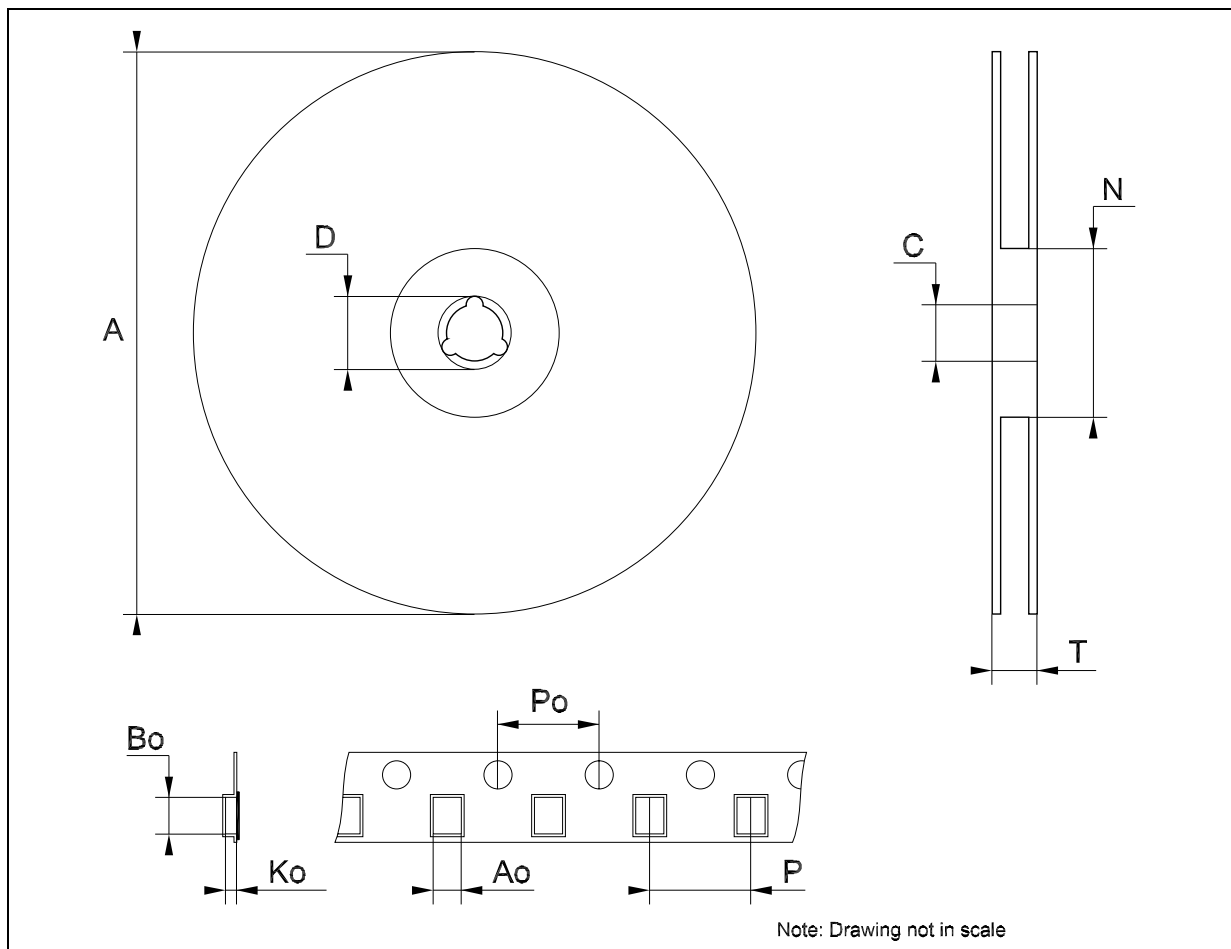
## SOT23-5L MECHANICAL DATA

DIM.	mm.			mils		
	MIN.	TYP	MAX.	MIN.	TYP.	MAX.
A	0.90		1.45	35.4		57.1
A1	0.00		0.10	0.0		3.9
A2	0.90		1.30	35.4		51.2
b	0.35		0.50	13.7		19.7
C	0.09		0.20	3.5		7.8
D	2.80		3.00	110.2		118.1
E	1.50		1.75	59.0		68.8
e		0.95			37.4	
H	2.60		3.00	102.3		118.1
L	0.10		0.60	3.9		23.6



**Tape & Reel SOT23-xL MECHANICAL DATA**

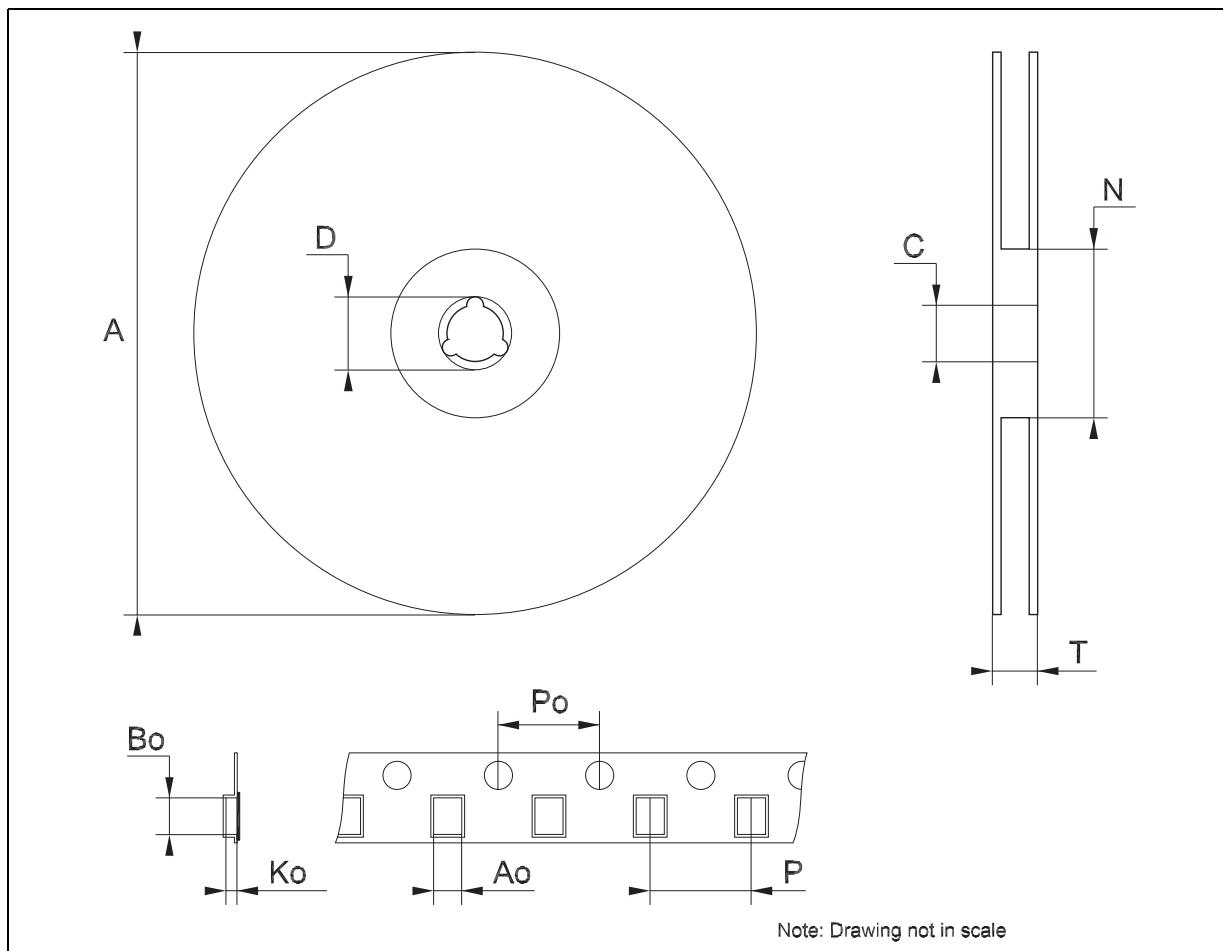
DIM.	mm.			inch		
	MIN.	TYP	MAX.	MIN.	TYP.	MAX.
A			180			7.086
C	12.8	13.0	13.2	0.504	0.512	0.519
D	20.2			0.795		
N	60			2.362		
T			14.4			0.567
Ao	3.13	3.23	3.33	0.123	0.127	0.131
Bo	3.07	3.17	3.27	0.120	0.124	0.128
Ko	1.27	1.37	1.47	0.050	0.054	0.058
Po	3.9	4.0	4.1	0.153	0.157	0.161
P	3.9	4.0	4.1	0.153	0.157	0.161



Note: Drawing not in scale

**Tape & Reel SOT89 MECHANICAL DATA**

DIM.	mm.			inch		
	MIN.	TYP	MAX.	MIN.	TYP.	MAX.
A			180			7.086
C	12.8	13.0	13.2	0.504	0.512	0.519
D	20.2			0.795		
N	60			2.362		
T			14.4			0.567
Ao	4.70	4.80	4.90	0.185	0.189	0.193
Bo	4.30	4.40	4.50	0.169	0.173	0.177
Ko	1.70	1.80	1.90	0.067	0.071	0.075
Po	3.9	4.0	4.1	0.153	0.157	0.161
P	7.9	8.0	8.1	0.311	0.315	0.319



## 8 Order code

Table 6. Order code

Part number				Output voltage
AB Version		C Version		
SOT23-5L	SOT-89	SOT23-5L	SOT-89	
		LD2981CM15TR		1.5 V
		LD2981CM18TR	LD2981CU18TR	1.8 V
LD2981ABM25TR	LD2981ABU25TR <sup>(1)</sup>	LD2981CM25TR	LD2981CU25TR <sup>(1)</sup>	2.5 V
LD2981ABM30TR	LD2981ABU30TR <sup>(1)</sup>	LD2981CM30TR	LD2981CU30TR <sup>(1)</sup>	3.0 V
LD2981ABM33TR	LD2981ABU33TR	LD2981CM33TR	LD2981CU33TR	3.3 V
LD2981ABM36TR	LD2981ABU36TR <sup>(1)</sup>	LD2981CM36TR	LD2981CU36TR <sup>(1)</sup>	3.6 V
LD2981ABM38TR	LD2981ABU38TR <sup>(1)</sup>	LD2981CM38TR	LD2981CU38TR <sup>(1)</sup>	3.8 V
LD2981ABM50TR	LD2981ABU50TR	LD2981CM50TR	LD2981CU50TR	5.0 V

1. Available on request.

## 9 Revision history

**Table 7. Revision history**

Date	Revision	Changes
25-Jul-2006	12	Order Codes has been updated and new template.

**Please Read Carefully:**

Information in this document is provided solely in connection with ST products. STMicroelectronics NV and its subsidiaries ("ST") reserve the right to make changes, corrections, modifications or improvements, to this document, and the products and services described herein at any time, without notice.

All ST products are sold pursuant to ST's terms and conditions of sale.

Purchasers are solely responsible for the choice, selection and use of the ST products and services described herein, and ST assumes no liability whatsoever relating to the choice, selection or use of the ST products and services described herein.

No license, express or implied, by estoppel or otherwise, to any intellectual property rights is granted under this document. If any part of this document refers to any third party products or services it shall not be deemed a license grant by ST for the use of such third party products or services, or any intellectual property contained therein or considered as a warranty covering the use in any manner whatsoever of such third party products or services or any intellectual property contained therein.

**UNLESS OTHERWISE SET FORTH IN ST'S TERMS AND CONDITIONS OF SALE ST DISCLAIMS ANY EXPRESS OR IMPLIED WARRANTY WITH RESPECT TO THE USE AND/OR SALE OF ST PRODUCTS INCLUDING WITHOUT LIMITATION IMPLIED WARRANTIES OF MERCHANTABILITY, FITNESS FOR A PARTICULAR PURPOSE (AND THEIR EQUIVALENTS UNDER THE LAWS OF ANY JURISDICTION), OR INFRINGEMENT OF ANY PATENT, COPYRIGHT OR OTHER INTELLECTUAL PROPERTY RIGHT.**

**UNLESS EXPRESSLY APPROVED IN WRITING BY AN AUTHORIZED ST REPRESENTATIVE, ST PRODUCTS ARE NOT RECOMMENDED, AUTHORIZED OR WARRANTED FOR USE IN MILITARY, AIR CRAFT, SPACE, LIFE SAVING, OR LIFE SUSTAINING APPLICATIONS, NOR IN PRODUCTS OR SYSTEMS WHERE FAILURE OR MALFUNCTION MAY RESULT IN PERSONAL INJURY, DEATH, OR SEVERE PROPERTY OR ENVIRONMENTAL DAMAGE. ST PRODUCTS WHICH ARE NOT SPECIFIED AS "AUTOMOTIVE GRADE" MAY ONLY BE USED IN AUTOMOTIVE APPLICATIONS AT USER'S OWN RISK.**

Resale of ST products with provisions different from the statements and/or technical features set forth in this document shall immediately void any warranty granted by ST for the ST product or service described herein and shall not create or extend in any manner whatsoever, any liability of ST.

ST and the ST logo are trademarks or registered trademarks of ST in various countries.

Information in this document supersedes and replaces all information previously supplied.

The ST logo is a registered trademark of STMicroelectronics. All other names are the property of their respective owners.

© 2006 STMicroelectronics - All rights reserved

STMicroelectronics group of companies

Australia - Belgium - Brazil - Canada - China - Czech Republic - Finland - France - Germany - Hong Kong - India - Israel - Italy - Japan - Malaysia - Malta - Morocco - Singapore - Spain - Sweden - Switzerland - United Kingdom - United States of America

[www.st.com](http://www.st.com)