



## Low Quiescent Current, Dual-Channel Supervisory Circuit

### FEATURES

- Two Supply Monitors in One Package
- One Monitor with Fixed High-Accuracy Thresholds for System Supply Monitoring
- Second Monitor with Variable Threshold and 30mV Hysteresis to Provide Failsafe
- Very Low Quiescent Current: 3.5µA typ
- High Threshold Accuracy: 1% max (0°C to +85°C)
- Open-Drain Reset Outputs
- Temperature Range: –40°C to +85°C
- Ultra-Small SC70-5 Package

### APPLICATIONS

- DSP, Microcontroller, or Microprocessor Applications Requiring User-Selected Delay Times
- Notebook/Desktop Computers
- PDAs and SmartPhones
- Other Hand-Held Products
- Portable, Battery-Powered Products
- FPGA/ASIC Applications

### DESCRIPTION

The TPS3807 family microprocessor supervisory circuits monitor system voltages as low as 1.225V. These devices assert an open-drain  $\overline{\text{RSTVDD}}$  signal when the  $V_{\text{DD}}$  voltage drops below a preset threshold. The  $\overline{\text{RSTVDD}}$  output remains asserted until the  $V_{\text{DD}}$  voltage returns above its threshold. The device also provides an additional  $\overline{\text{RSTSENSE}}$  output for a SENSE input with adjustable thresholds and hysteresis.

The TPS3807 uses a precision reference to achieve 1% threshold accuracy. The TPS3807 has a very low typical quiescent current of 3.5µA, so it is well-suited to battery-powered applications. It is available in a small SC70-5 package, which is half the size of a SOT-23 package, and is fully specified over a temperature range of –40°C to +85°C.

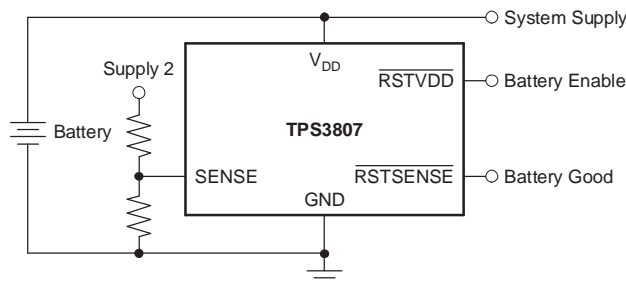

Typical Application Circuit

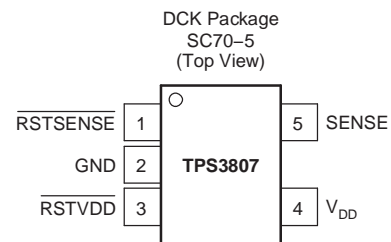

Please be aware that an important notice concerning availability, standard warranty, and use in critical applications of Texas Instruments semiconductor products and disclaimers thereto appears at the end of this data sheet.

All trademarks are the property of their respective owners.



This integrated circuit can be damaged by ESD. Texas Instruments recommends that all integrated circuits be handled with appropriate precautions. Failure to observe proper handling and installation procedures can cause damage.

ESD damage can range from subtle performance degradation to complete device failure. Precision integrated circuits may be more susceptible to damage because very small parametric changes could cause the device not to meet its published specifications.

### ORDERING INFORMATION<sup>(1)</sup>

PRODUCT	V <sub>DD</sub> NEGATIVE THRESHOLD VOLTAGE (V <sub>DD IT-</sub> ) <sup>(2)</sup>	V <sub>DD</sub> POSITIVE THRESHOLD VOLTAGE (V <sub>DD IT+</sub> ) <sup>(2)</sup>	SENSE THRESHOLD VOLTAGE (V <sub>SENSE IT</sub> )
TPS3807A30DCKT <sup>(3)</sup>	3.00V	3.58V	1.225V
TPS3807A30DCKR <sup>(4)</sup>	3.00V	3.58V	1.225V

- (1) For the most current package and ordering information, see the Package Option Addendum at the end of this document or see the TI web site at [www.ti.com](http://www.ti.com).
- (2) Other voltage options are available upon request; minimum order quantities may apply.
- (3) DCKT passive indicates tape and reel containing 250 parts.
- (4) The DCKR passive indicates tape and reel containing 3000 parts.

### ABSOLUTE MAXIMUM RATINGS

Over operating free-air temperature range, unless otherwise noted.<sup>(1)</sup>

SENSE pin voltage <sup>(2)</sup>	-0.3V to +5V
$\overline{MR}$	-0.3V to V <sub>DD</sub> +0.3V
RESET	-0.3V to V <sub>DD</sub> +0.3V
All other pins <sup>(2)</sup>	-0.3V to +7V
Maximum output current	±5mA
Input clamp current, I <sub>IK</sub> (V <sub>SENSE</sub> < 0 or V <sub>SENSE</sub> > V <sub>DD</sub> )	±10mA
Output clamp current, I <sub>OK</sub> (V <sub>O</sub> < 0 or V <sub>O</sub> > V <sub>DD</sub> )	±10mA
Continuous total power dissipation	See <i>Dissipation Ratings</i> table
Junction temperature, T <sub>C</sub>	-40°C to +125°C
Storage temperature range, T <sub>STG</sub>	-65°C to +150°C
Soldering temperature	+260°C
ESD rating:	
Human body model (HBM)	2kV
Charged device model (CDM)	500V

- (1) Stresses beyond those listed under *absolute maximum ratings* may cause permanent damage to the device. These are stress ratings only and functional operation of the device at these conditions is not implied. Exposure to absolute-maximum-rated conditions for extended periods may affect device reliability.
- (2) All voltage values are with respect to GND. For reliable operation, the device must not be continuously operated at 7V for more than t = 1000 hours.

### DISSIPATION RATINGS

PACKAGE	θ <sub>JA</sub>	DERATING FACTOR ABOVE T <sub>A</sub> = +25°C	T <sub>A</sub> < +25°C POWER RATING	T <sub>A</sub> = +70°C POWER RATING	T <sub>A</sub> = +80°C POWER RATING
DCK	+246°C/W	2.6mW/°C	406mW	223mW	167mW

### RECOMMENDED OPERATING CONDITIONS

		MIN	MAX	UNIT
Supply voltage, V <sub>DD</sub>		1.8	6.5	V
Input voltage, V <sub>SENSE</sub>	0V ≤ V <sub>DD</sub> ≤ 4.2V	0	V <sub>DD</sub> + 0.3	V
	V <sub>DD</sub> ≥ 4.2V		4.5	
Operating free-air temperature range, T <sub>A</sub>		-40°C	+85°C	°C

## ELECTRICAL CHARACTERISTICS

Over recommended operating temperature range, unless otherwise noted.

PARAMETER		TEST CONDITIONS	MIN	TYP	MAX	UNIT
$V_{DD}$	Input supply range		1.8		6.5	V
$I_{DD}$	Supply current	$V_{DD} = 3.3V$ $\overline{RSTVDD}, \overline{RSTSENSE} = \text{open}$		3.5	6.5	$\mu\text{A}$
		$V_{DD} = 6.5V$ $\overline{RSTVDD}, \overline{RSTSENSE} = \text{open}$		4.5	7.5	$\mu\text{A}$
$V_{OL}$	Low-level output voltage	$V_{DD} = 1.3V, I_{OL} = 0.4\text{mA}$			0.3	V
		$V_{DD} = 1.8V, I_{OL} = 1\text{mA}$			0.4	
		$V_{DD} = 3.3V, I_{OL} = 2\text{mA}$			0.4	
	Power-up reset <sup>(1)</sup>	$V_{\overline{RSTVDD}}(\text{max}) = 0.2V$ , $I_{OL} = 30\mu\text{A}, +25^\circ\text{C}$	0.9			V
$V_{DD\ IT-}$	Negative-going input threshold voltage <sup>(2)</sup>		2.963	3.000	3.037	V
$V_{DD\ IT+}$	Positive-going input threshold voltage <sup>(2)</sup>		3.530	3.575	3.620	V
$V_{SENSE\ IT-}$	Negative-going input threshold voltage	$0^\circ\text{C to } +85^\circ\text{C}$	1.213	1.225	1.237	V
		$-40^\circ\text{C to } +85^\circ\text{C}$	1.210	1.225	1.240	
$V_{HYS}$	SENSE input hysteresis			30		mV
$I_{SENSE}$	Input current		-25		+25	nA
$C_I$	Input capacitance	$V_I = 0V \text{ to } V_{DD}$		1		pF
$I_{OH}$	High-level output current	$V_{\overline{RSTVDD}}, \overline{RSTSENSE} = 6.5V$			300	nA

(1) The lowest supply voltage at which  $\overline{RSTVDD}$  ( $V_{\overline{RSTVDD}}(\text{max}) = 0.2V, I_{OL} = 30\mu\text{A}$ ) becomes active.  $t_r, V_{DD} \geq 15\mu\text{s/V}$ .

(2) To ensure best stability of the threshold voltage, a bypass capacitor (ceramic,  $0.1\mu\text{F}$ ) should be placed near the  $V_{DD}$  pin.

## TIMING REQUIREMENTS

At  $T_A = -40^\circ\text{C to } +85^\circ\text{C}$ ,  $R_L = 1\text{M}\Omega$ , and  $C_L = 50\text{pF}$ , unless otherwise noted.

PARAMETER		TEST CONDITIONS	MIN	TYP	MAX	UNIT
$t_W$	Pulse width	$V_{IH} = 1.05V_{IT}, V_{IL} = 0.95V_{IT}$	10			$\mu\text{s}$

## SWITCHING CHARACTERISTICS

At  $T_A = -40^\circ\text{C to } +85^\circ\text{C}$ ,  $R_L = 1\text{M}\Omega$ , and  $C_L = 50\text{pF}$ , unless otherwise noted.

PARAMETER		TEST CONDITIONS	MIN	TYP	MAX	UNIT
$t_{PHL}$	Propagation delay time, high-to-low-level output	$V_{DD} \text{ to } \overline{RSTVDD}$	$V_{IH} = 1.05V_{IT}, V_{IL} = 0.95V_{IT}$	20		$\mu\text{s}$
		$\overline{SENSE} \text{ to } \overline{RSTSENSE}$				

**FUNCTIONAL BLOCK DIAGRAM**

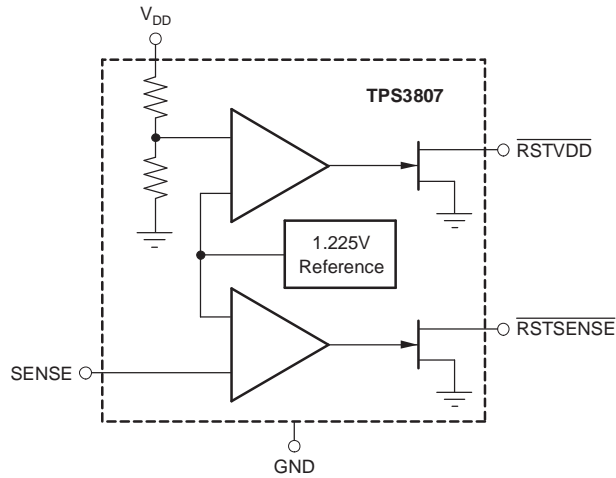

**Table 1. PIN DESCRIPTIONS**

NAME	PIN NO.	I/O	DESCRIPTION
$\overline{\text{RSTSENSE}}$	1	O	$\overline{\text{RSTSENSE}}$ is an open-drain output that is driven to a low-impedance state when the SENSE input is lower than the threshold voltage $V_{\text{SENSE IT-}}$ . $\overline{\text{RSTSENSE}}$ will remain low until SENSE is above $V_{\text{SENSE IT+}}$ . A pull-up resistor from 10k $\Omega$ to 1M $\Omega$ should be used on this pin, and allows the reset pin to attain voltages higher than $V_{\text{DD}}$ .
GND	2	I	Ground
$\overline{\text{RSTVDD}}$	3	O	$\overline{\text{RSTVDD}}$ is an open-drain output that is driven to a low-impedance state when the $V_{\text{DD}}$ input is lower than the threshold voltage $V_{\text{DD IT-}}$ . $\overline{\text{RSTVDD}}$ will remain low until $V_{\text{DD}}$ is above $V_{\text{DD IT+}}$ . A pull-up resistor from 10k $\Omega$ to 1M $\Omega$ should be used on this pin, and allows the reset pin to attain voltages higher than $V_{\text{DD}}$ .
$V_{\text{DD}}$	4	I	Supply voltage for the device and sense input for fixed-threshold $\overline{\text{RSTVDD}}$ outputs. A 0.1 $\mu\text{F}$ ceramic capacitor should be placed close to this pin for best $V_{\text{IT}}$ stability.
SENSE	5	I	Sense input for the adjustable-threshold $\overline{\text{RSTSENSE}}$ outputs. A resistor divider from the sense voltage can be attached to this pin to set the thresholds to the desired voltages. A 0.1 $\mu\text{F}$ ceramic capacitor should be placed close to this pin for best $V_{\text{IT}}$ stability.

**TIMING DIAGRAM**

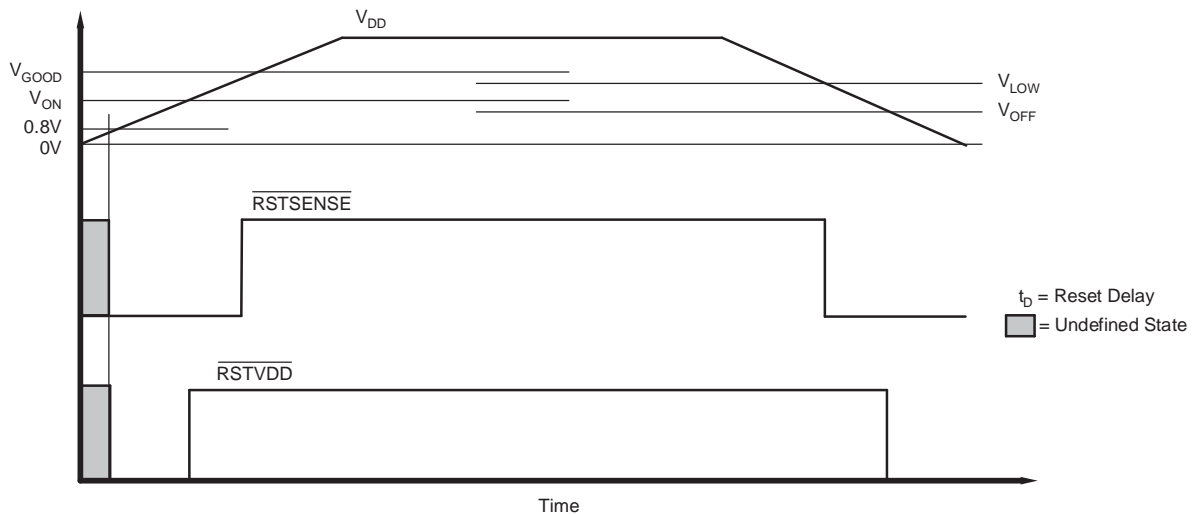

**Figure 1. TPS3807 Timing Diagram Showing Reset Timing (SENSE resistor divider set to 3.6V)**

**TYPICAL CHARACTERISTICS**

At  $T_A = +25^\circ\text{C}$ ,  $V_{DD} = 3.3\text{V}$ ,  $R_{LRESET} = 1\text{M}\Omega$ , and  $C_{LRESET} = 50\text{pF}$ , unless otherwise noted.

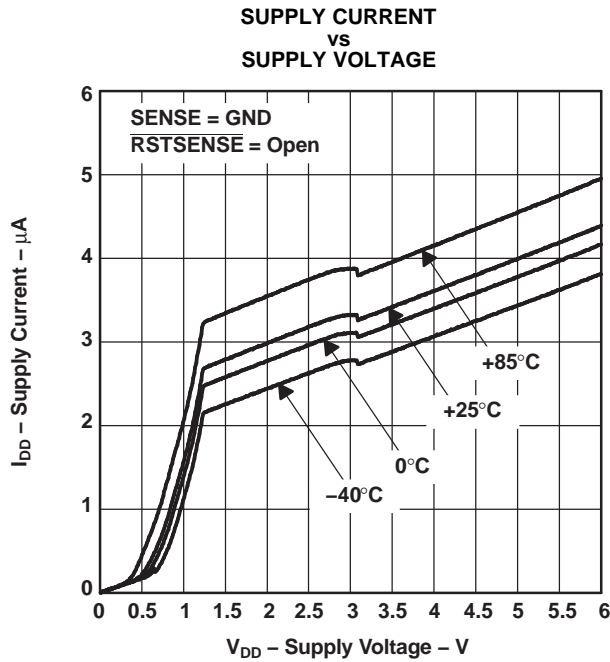

Figure 2.

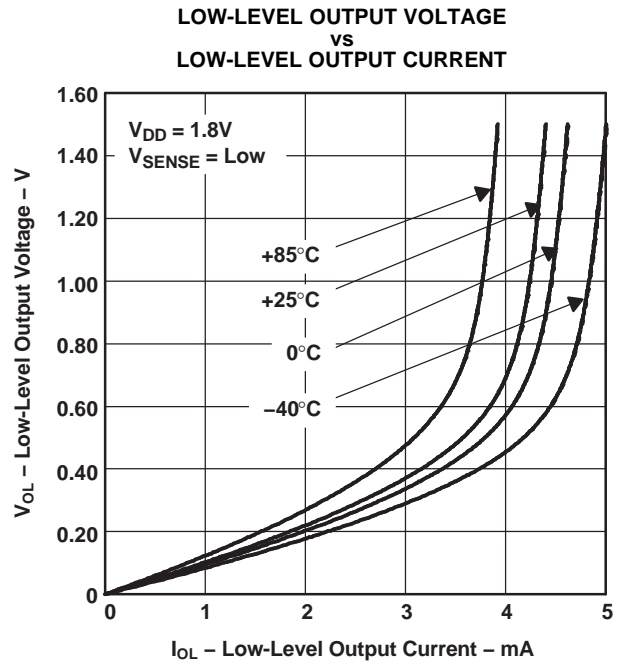

Figure 3.

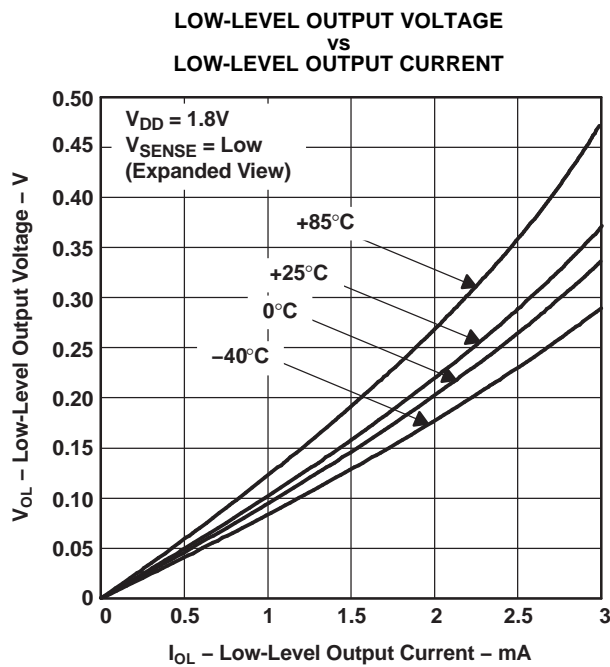

Figure 4.

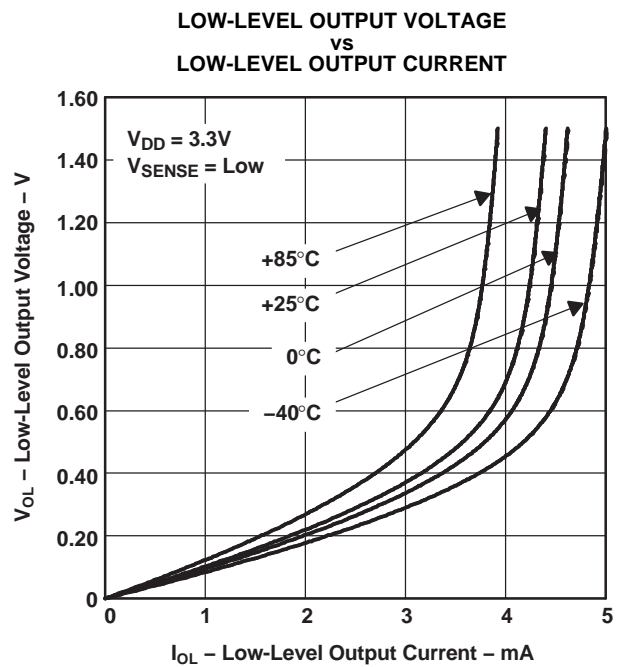
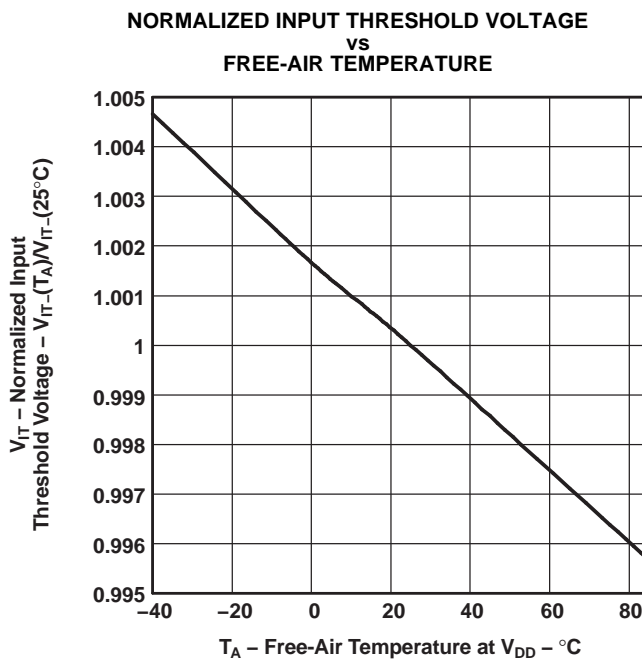
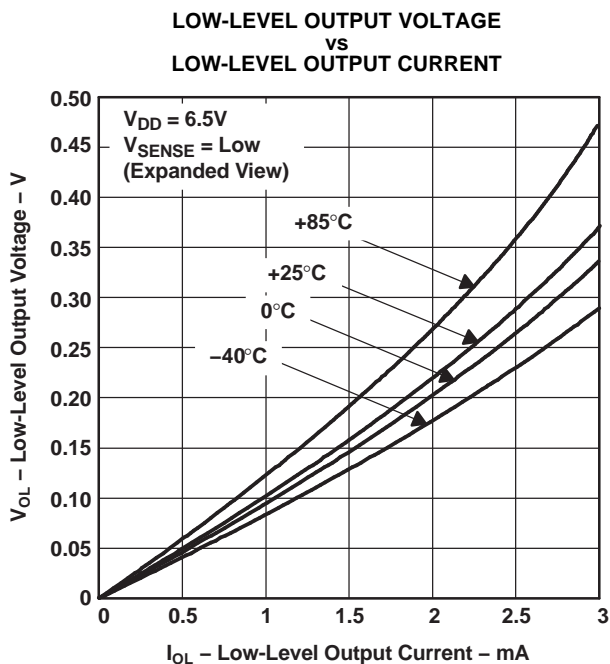
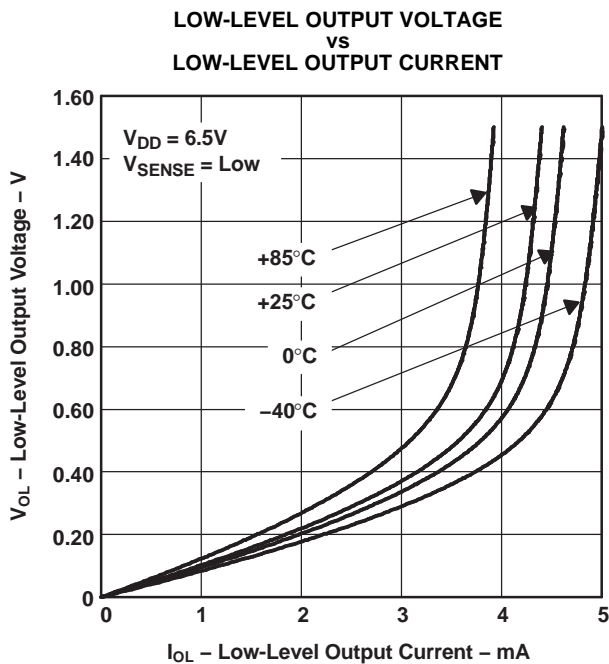
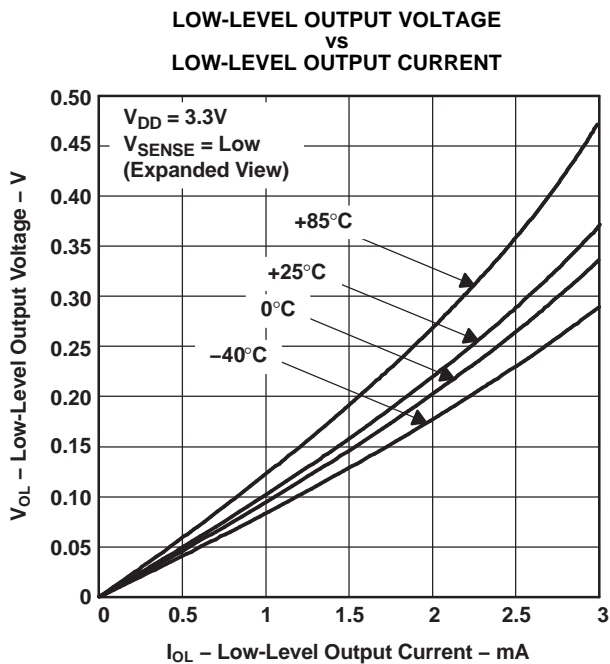

Figure 5.

**TYPICAL CHARACTERISTICS (continued)**

At  $T_A = +25^\circ\text{C}$ ,  $V_{DD} = 3.3\text{V}$ ,  $R_{LRESET} = 1\text{M}\Omega$ , and  $C_{LRESET} = 50\text{pF}$ , unless otherwise noted.



**TYPICAL CHARACTERISTICS (continued)**

At  $T_A = +25^\circ\text{C}$ ,  $V_{DD} = 3.3\text{V}$ ,  $R_{LRESET} = 1\text{M}\Omega$ , and  $C_{LRESET} = 50\text{pF}$ , unless otherwise noted.

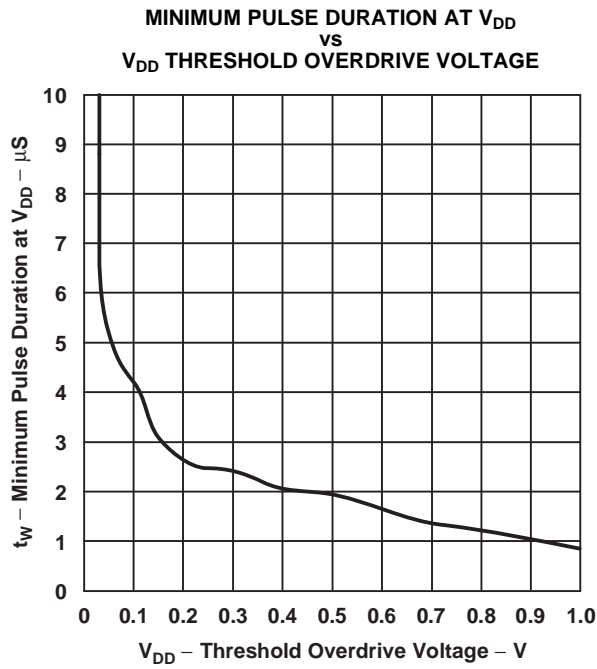

Figure 10.

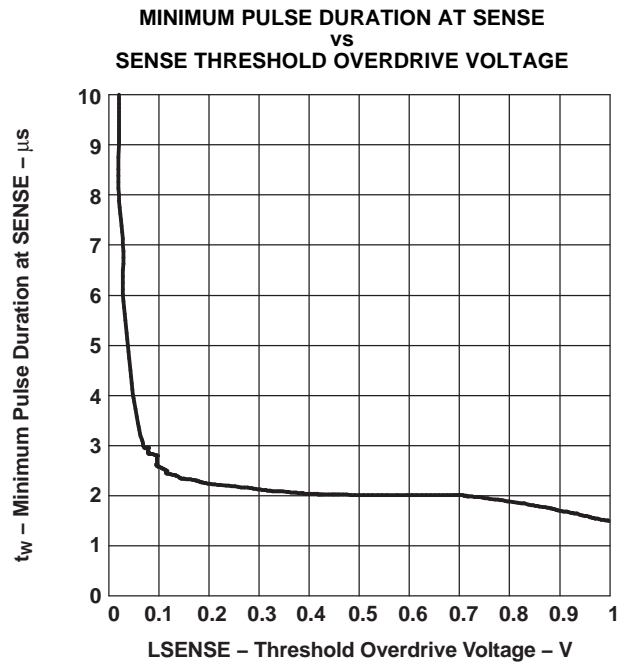

Figure 11.

**PACKAGING INFORMATION**

Orderable Device	Status (1)	Package Type	Package Drawing	Pins	Package Qty	Eco Plan (2)	Lead finish/ Ball material (6)	MSL Peak Temp (3)	Op Temp (°C)	Device Marking (4/5)	Samples
TPS3807A30DCKR	ACTIVE	SC70	DCK	5	3000	RoHS & Green	NIPDAUAG	Level-1-260C-UNLIM	-40 to 85	BOM	<a href="#">Samples</a>
TPS3807A30DCKT	ACTIVE	SC70	DCK	5	250	RoHS & Green	NIPDAUAG	Level-1-260C-UNLIM	-40 to 85	BOM	<a href="#">Samples</a>

(1) The marketing status values are defined as follows:

**ACTIVE:** Product device recommended for new designs.

**LIFEBUY:** TI has announced that the device will be discontinued, and a lifetime-buy period is in effect.

**NRND:** Not recommended for new designs. Device is in production to support existing customers, but TI does not recommend using this part in a new design.

**PREVIEW:** Device has been announced but is not in production. Samples may or may not be available.

**OBSOLETE:** TI has discontinued the production of the device.

(2) **RoHS:** TI defines "RoHS" to mean semiconductor products that are compliant with the current EU RoHS requirements for all 10 RoHS substances, including the requirement that RoHS substance do not exceed 0.1% by weight in homogeneous materials. Where designed to be soldered at high temperatures, "RoHS" products are suitable for use in specified lead-free processes. TI may reference these types of products as "Pb-Free".

**RoHS Exempt:** TI defines "RoHS Exempt" to mean products that contain lead but are compliant with EU RoHS pursuant to a specific EU RoHS exemption.

**Green:** TI defines "Green" to mean the content of Chlorine (Cl) and Bromine (Br) based flame retardants meet JS709B low halogen requirements of <=1000ppm threshold. Antimony trioxide based flame retardants must also meet the <=1000ppm threshold requirement.

(3) MSL, Peak Temp. - The Moisture Sensitivity Level rating according to the JEDEC industry standard classifications, and peak solder temperature.

(4) There may be additional marking, which relates to the logo, the lot trace code information, or the environmental category on the device.

(5) Multiple Device Markings will be inside parentheses. Only one Device Marking contained in parentheses and separated by a "~" will appear on a device. If a line is indented then it is a continuation of the previous line and the two combined represent the entire Device Marking for that device.

(6) Lead finish/Ball material - Orderable Devices may have multiple material finish options. Finish options are separated by a vertical ruled line. Lead finish/Ball material values may wrap to two lines if the finish value exceeds the maximum column width.

**Important Information and Disclaimer:**The information provided on this page represents TI's knowledge and belief as of the date that it is provided. TI bases its knowledge and belief on information provided by third parties, and makes no representation or warranty as to the accuracy of such information. Efforts are underway to better integrate information from third parties. TI has taken and continues to take reasonable steps to provide representative and accurate information but may not have conducted destructive testing or chemical analysis on incoming materials and chemicals. TI and TI suppliers consider certain information to be proprietary, and thus CAS numbers and other limited information may not be available for release.

In no event shall TI's liability arising out of such information exceed the total purchase price of the TI part(s) at issue in this document sold by TI to Customer on an annual basis.





## TAPE AND REEL INFORMATION



### QUADRANT ASSIGNMENTS FOR PIN 1 ORIENTATION IN TAPE



\*All dimensions are nominal

Device	Package Type	Package Drawing	Pins	SPQ	Reel Diameter (mm)	Reel Width W1 (mm)	A0 (mm)	B0 (mm)	K0 (mm)	P1 (mm)	W (mm)	Pin1 Quadrant
TPS3807A30DCKR	SC70	DCK	5	3000	180.0	8.4	2.41	2.41	1.2	4.0	8.0	Q3
TPS3807A30DCKT	SC70	DCK	5	250	180.0	8.4	2.41	2.41	1.2	4.0	8.0	Q3

**TAPE AND REEL BOX DIMENSIONS**

\*All dimensions are nominal

Device	Package Type	Package Drawing	Pins	SPQ	Length (mm)	Width (mm)	Height (mm)
TPS3807A30DCKR	SC70	DCK	5	3000	183.0	183.0	20.0
TPS3807A30DCKT	SC70	DCK	5	250	183.0	183.0	20.0

DCK (R-PDSO-G5)

PLASTIC SMALL-OUTLINE PACKAGE



- NOTES:
- A. All linear dimensions are in millimeters.
  - B. This drawing is subject to change without notice.
  - C. Body dimensions do not include mold flash or protrusion. Mold flash and protrusion shall not exceed 0.15 per side.
  - D. Falls within JEDEC MO-203 variation AA.

DCK (R-PDSO-G5)

PLASTIC SMALL OUTLINE



- NOTES:
- All linear dimensions are in millimeters.
  - This drawing is subject to change without notice.
  - Customers should place a note on the circuit board fabrication drawing not to alter the center solder mask defined pad.
  - Publication IPC-7351 is recommended for alternate designs.
  - Laser cutting apertures with trapezoidal walls and also rounding corners will offer better paste release. Customers should contact their board assembly site for stencil design recommendations. Example stencil design based on a 50% volumetric metal load solder paste. Refer to IPC-7525 for other stencil recommendations.

## IMPORTANT NOTICE AND DISCLAIMER

TI PROVIDES TECHNICAL AND RELIABILITY DATA (INCLUDING DATASHEETS), DESIGN RESOURCES (INCLUDING REFERENCE DESIGNS), APPLICATION OR OTHER DESIGN ADVICE, WEB TOOLS, SAFETY INFORMATION, AND OTHER RESOURCES "AS IS" AND WITH ALL FAULTS, AND DISCLAIMS ALL WARRANTIES, EXPRESS AND IMPLIED, INCLUDING WITHOUT LIMITATION ANY IMPLIED WARRANTIES OF MERCHANTABILITY, FITNESS FOR A PARTICULAR PURPOSE OR NON-INFRINGEMENT OF THIRD PARTY INTELLECTUAL PROPERTY RIGHTS.

These resources are intended for skilled developers designing with TI products. You are solely responsible for (1) selecting the appropriate TI products for your application, (2) designing, validating and testing your application, and (3) ensuring your application meets applicable standards, and any other safety, security, or other requirements. These resources are subject to change without notice. TI grants you permission to use these resources only for development of an application that uses the TI products described in the resource. Other reproduction and display of these resources is prohibited. No license is granted to any other TI intellectual property right or to any third party intellectual property right. TI disclaims responsibility for, and you will fully indemnify TI and its representatives against, any claims, damages, costs, losses, and liabilities arising out of your use of these resources.

TI's products are provided subject to TI's Terms of Sale ([www.ti.com/legal/termsofsale.html](http://www.ti.com/legal/termsofsale.html)) or other applicable terms available either on [ti.com](http://ti.com) or provided in conjunction with such TI products. TI's provision of these resources does not expand or otherwise alter TI's applicable warranties or warranty disclaimers for TI products.

Mailing Address: Texas Instruments, Post Office Box 655303, Dallas, Texas 75265  
Copyright © 2020, Texas Instruments Incorporated