

CS35L00/01/03

3W MONO CLASS-D AUDIO AMPLIFIER WITH LOW IDLE CURRENT

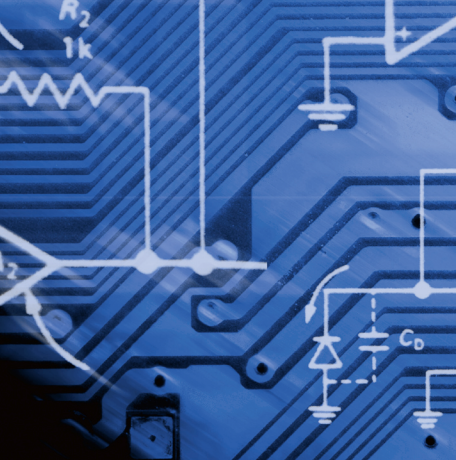

CS35L00 10-PIN DFN

(actual size: 3 mm x 3 mm)



CS35L01/03 9-BALL WLCSP

(actual size: 1.2 mm x 1.2 mm)



MARKET APPLICATIONS

- Smartphones
- UMPC/MID
- Docking Stations
- Active Speakers
- Portable Gaming

CIRRUS LOGIC, INC.

2901 Via Fortuna
Austin, Texas 78746

United States

T +1-512-851-4000

Toll-Free +1-800-888-5016

SALES SUPPORT

North America +1 800-625-4084

Asia Pacific +852 2376-0801

Japan +81 (3) 5226-7757

Europe/UK +44 (90) 1628-891-300

LEARN MORE AT

www.cirrus.com

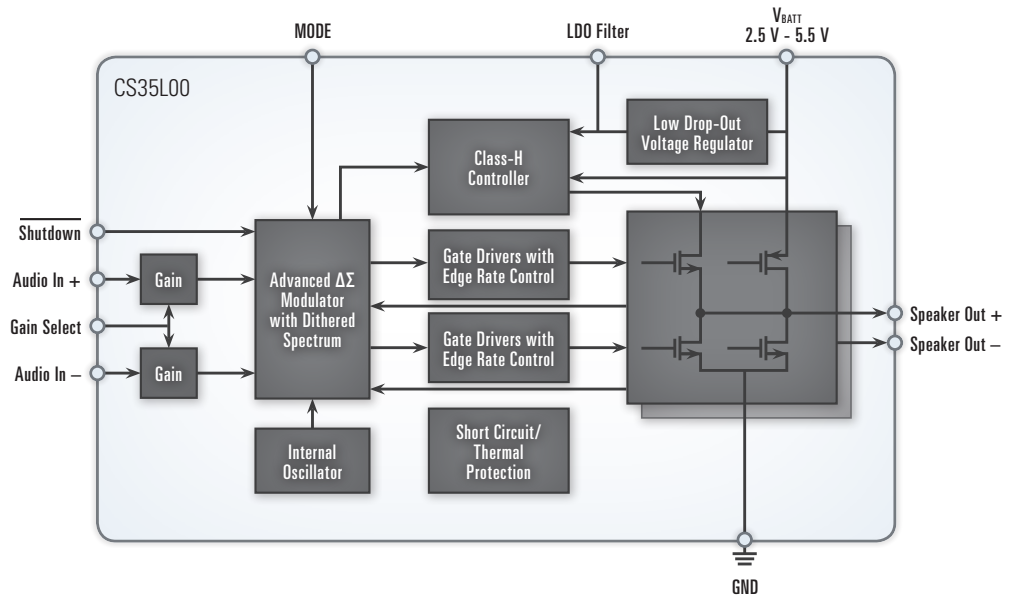

OVERVIEW

The CS35L00, L01 and L03 are a family of low-power audio amplifiers with Cirrus Logic's proprietary Hybrid Class-D Architecture, designed specifically for today's mobile applications. Combining the benefits of both linear and switching amplifier technologies, its Hybrid Class-D architecture offers best-in-class idle power consumption and low radiated emission while maintaining high output power efficiency and superior audio quality.

The CS35L0X family has the industry's lowest quiescent current at less than 1mA. When used with no external filter components, it is at least 40 percent lower than the closest competitor in the market today. Furthermore, the Hybrid Class-D Architecture allows designers to optimize their system performance with external components if needed, such as with an external shunt cap without sacrificing significant power consumption when idle.

Quiescent Current Comparison

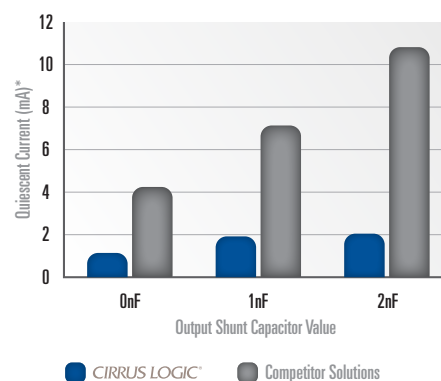

THIS FLEXIBLE HYBRID CLASS-D OUTPUT STAGE OFFERS FOUR MODES OF OPERATION:

Standard Class-D (SD) mode offers full audio bandwidth and high audio performance

Hybrid Class-D (HD) mode offers a substantial reduction in idle power consumption with an integrated Class-H controller

Reduced Frequency Class-D (FSD) mode reduces the output switching frequency, producing lower electromagnetic interference (EMI)

Reduced Frequency Hybrid Class-D (FHD) mode produces both the lower idle power consumption of HD mode and the reduced EMI benefits of FSD mode

Requiring minimal external components and PCB space, the CS35L00 is available in 3 mm x 3 mm, 10-pin DFN package and the CS35L01/03 are available in a 1.2 mm x 1.2 mm, 9-ball WLCSP package with Commercial temperature grade (-10°C to +70°C).

For the full datasheet, visit www.cirrus.com/support.

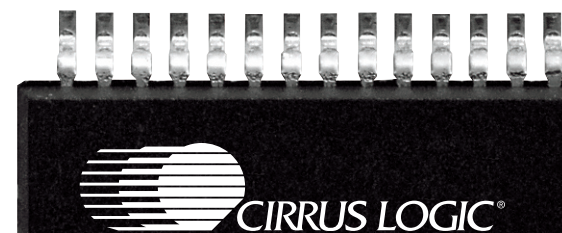

CS35L00/01/03 FEATURES

HYBRID CLASS-D ARCHITECTURE

- 1 x 3.0 W into 4 Ω (10% THD+N)
- 1 x 2.3 W into 4 Ω (1% THD+N)
- 1 x 1.7 W into 8 Ω (10% THD+N)
- 1 x 1.4 W into 8 Ω (1% THD+N)

ULTRA-LOW POWER CONSUMPTION

- <1 mA Quiescent Current

ADVANCED ΔΣ CLOSED-LOOP MODULATION

- 98 dB Signal-to-Noise Ratio (A-Weighted)
- 0.02% THD+N @ 1 W (SD & HD Mode)
- -85 dB Power Supply Rejection Ratio @ 217Hz
- -70 dB Common Mode Rejection Ratio
- Integrated Protection and Automatic Recovery for Output Short-circuit and Thermal Overload
- Pop and Click Suppression

AVAILABLE IN LOW-PROFILE 10-PIN DFN OR 9-BALL WLCSP

- CS35L00: +6 dB or +12 dB Selectable Gain
- CS35L01: +6 dB default Gain
- CS35L03: +12 dB default Gain

DEMONSTRATION BOARD CDB35L00

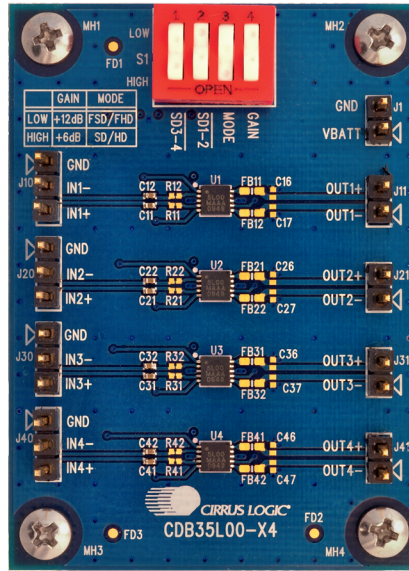

REFERENCE BOARD CRD35L01

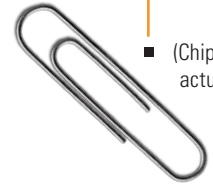
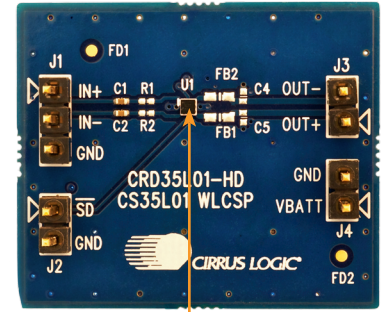

(Chip shown at actual size)

PRODUCT SELECTOR

Part	Power (W)	Dynamic Range (dB)	THD+N %	PSRR (dB)	Channels	Power Supply (V)	Gain	Comments	Package
CS35L00	3.0	98	0.02	-85	1	2.5 to 5.5	Selectable +6/+12 dB	Hybrid Class-D architecture, < 1mA quiescent current	10 DFN
CS35L01	3.0	98	0.02	-85	1	2.5 to 5.5	+6 dB	Hybrid Class-D architecture, < 1mA quiescent current	9 WLCSP
CS35L03	3.0	98	0.02	-85	1	2.5 to 5.5	+12 dB	Hybrid Class-D architecture, < 1mA quiescent current	9 WLCSP