

Inductors for standard circuits
Wound ferrite
NLV-EFD series (for automotive)



AEC-Q200

NLV32-EFD type



FEATURES

- Resin mold type wound inductor for standard circuits.
- E-12 series, wide lineup compatible with J ($\pm 5\%$) tolerance, can be used for applications that need to meet strict L tolerance such as filter circuits.
- Has excellent inductance temperature characteristics in the operating temperature range.
- Operating temperature range: -40 to $+105^{\circ}\text{C}$ (including self-temperature rise)
- Compliant with AEC-Q200

APPLICATION

- Vehicle accessories (car navigation systems, car audio, ETC)

PART NUMBER CONSTRUCTION

NLV	32	T	-	010	-	J	-	EFD
Series name	LxWxH dimensions 3.2x2.5x2.2 mm	Packaging style		Inductance (μH)		Inductance tolerance		Internal code

CHARACTERISTICS SPECIFICATION TABLE

L	Q	L, Q measuring frequency	Self-resonant frequency	DC resistance	Rated current	Part No.	
(μH)	Tolerance	min. (MHz)	(MHz)min.	(Ω)max.	(mA)max.		
0.01	$\pm 5\%$	15	100	2500	0.13	450	NLV32T-010J-EFD
0.012	$\pm 5\%$	17	100	2300	0.14	450	NLV32T-012J-EFD
0.015	$\pm 5\%$	19	100	2100	0.16	450	NLV32T-015J-EFD
0.018	$\pm 5\%$	21	100	1900	0.18	450	NLV32T-018J-EFD
0.022	$\pm 5\%$	23	100	1700	0.2	450	NLV32T-022J-EFD
0.027	$\pm 5\%$	23	100	1500	0.22	450	NLV32T-027J-EFD
0.033	$\pm 5\%$	25	100	1400	0.24	450	NLV32T-033J-EFD
0.039	$\pm 5\%$	25	100	1300	0.27	450	NLV32T-039J-EFD
0.047	$\pm 5\%$	26	100	1200	0.3	450	NLV32T-047J-EFD
0.056	$\pm 5\%$	26	100	1100	0.33	450	NLV32T-056J-EFD
0.068	$\pm 5\%$	27	100	1000	0.36	450	NLV32T-068J-EFD
0.082	$\pm 5\%$	27	100	900	0.4	450	NLV32T-082J-EFD
0.1	$\pm 5\%$	28	100	700	0.44	450	NLV32T-R10J-EFD

Measurement equipment

Measurement item	Product No.	Manufacturer
L, Q	4294A+16197A 4294A+16093B	Keysight Technologies
Self-resonant frequency	E5063A	Keysight Technologies
DC resistance	AX-114N	ADEX

* Equivalent measurement equipment may be used.

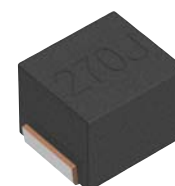

NLV32-EFD type

CHARACTERISTICS SPECIFICATION TABLE

L	Q	L, Q measuring frequency	Self-resonant frequency	DC resistance	Rated current	Part No.	
(μ H)	Tolerance	min.	(MHz)	(Ω)max.	(mA)max.		
0.12	$\pm 5\%$	30	25.2	500	0.22	450	NLV32T-R12J-EFD
0.15	$\pm 5\%$	30	25.2	450	0.25	450	NLV32T-R15J-EFD
0.18	$\pm 5\%$	30	25.2	400	0.28	450	NLV32T-R18J-EFD
0.22	$\pm 5\%$	30	25.2	350	0.32	450	NLV32T-R22J-EFD
0.27	$\pm 5\%$	30	25.2	320	0.36	450	NLV32T-R27J-EFD
0.33	$\pm 5\%$	30	25.2	300	0.4	450	NLV32T-R33J-EFD
0.39	$\pm 5\%$	30	25.2	250	0.45	450	NLV32T-R39J-EFD
0.47	$\pm 5\%$	30	25.2	220	0.5	450	NLV32T-R47J-EFD
0.56	$\pm 5\%$	30	25.2	180	0.55	450	NLV32T-R56J-EFD
0.68	$\pm 5\%$	30	25.2	160	0.6	450	NLV32T-R68J-EFD
0.82	$\pm 5\%$	30	25.2	140	0.65	450	NLV32T-R82J-EFD
1	$\pm 5\%$	30	7.96	120	0.7	400	NLV32T-1R0J-EFD
1.2	$\pm 5\%$	30	7.96	100	0.75	390	NLV32T-1R2J-EFD
1.5	$\pm 5\%$	30	7.96	85	0.85	370	NLV32T-1R5J-EFD
1.8	$\pm 5\%$	30	7.96	80	0.9	350	NLV32T-1R8J-EFD
2.2	$\pm 5\%$	30	7.96	75	1	320	NLV32T-2R2J-EFD
2.7	$\pm 5\%$	30	7.96	70	1.1	290	NLV32T-2R7J-EFD
3.3	$\pm 5\%$	30	7.96	60	1.2	260	NLV32T-3R3J-EFD
3.9	$\pm 5\%$	30	7.96	55	1.3	250	NLV32T-3R9J-EFD
4.7	$\pm 5\%$	30	7.96	50	1.5	220	NLV32T-4R7J-EFD
5.6	$\pm 5\%$	30	7.96	45	1.6	200	NLV32T-5R6J-EFD
6.8	$\pm 5\%$	30	7.96	40	1.8	180	NLV32T-6R8J-EFD
8.2	$\pm 5\%$	30	7.96	35	2	170	NLV32T-8R2J-EFD
10	$\pm 5\%$	30	2.52	30	2.1	150	NLV32T-100J-EFD
12	$\pm 5\%$	30	2.52	20	2.5	140	NLV32T-120J-EFD
15	$\pm 5\%$	30	2.52	20	2.8	130	NLV32T-150J-EFD
18	$\pm 5\%$	30	2.52	20	3.3	120	NLV32T-180J-EFD
22	$\pm 5\%$	30	2.52	20	3.7	110	NLV32T-220J-EFD
27	$\pm 5\%$	30	2.52	20	5	80	NLV32T-270J-EFD
33	$\pm 5\%$	30	2.52	17	5.6	70	NLV32T-330J-EFD
39	$\pm 5\%$	30	2.52	16	6.4	65	NLV32T-390J-EFD
47	$\pm 5\%$	30	2.52	15	7	60	NLV32T-470J-EFD
56	$\pm 5\%$	30	2.52	13	8	55	NLV32T-560J-EFD
68	$\pm 5\%$	30	2.52	12	9	50	NLV32T-680J-EFD
82	$\pm 5\%$	30	2.52	11	10	45	NLV32T-820J-EFD
100	$\pm 5\%$	20	0.796	10	10	40	NLV32T-101J-EFD
120	$\pm 5\%$	20	0.796	10	11	70	NLV32T-121J-EFD
150	$\pm 5\%$	20	0.796	8	15	65	NLV32T-151J-EFD
180	$\pm 5\%$	20	0.796	7	17	60	NLV32T-181J-EFD
220	$\pm 5\%$	20	0.796	7	21	50	NLV32T-221J-EFD
270	$\pm 5\%$	20	0.796	6	28	45	NLV32T-271J-EFD
330	$\pm 5\%$	20	0.796	5	34	40	NLV32T-331J-EFD
390	$\pm 5\%$	20	0.796	5	36	35	NLV32T-391J-EFD
470	$\pm 5\%$	20	0.796	4	40	25	NLV32T-471J-EFD

Measurement equipment

Measurement item	Product No.	Manufacturer
L, Q	4294A+16197A 4294A+16093B	Keysight Technologies
Self-resonant frequency	E5063A	Keysight Technologies
DC resistance	AX-114N	ADEX

* Equivalent measurement equipment may be used.

NLV32-EFD type

L FREQUENCY CHARACTERISTICS

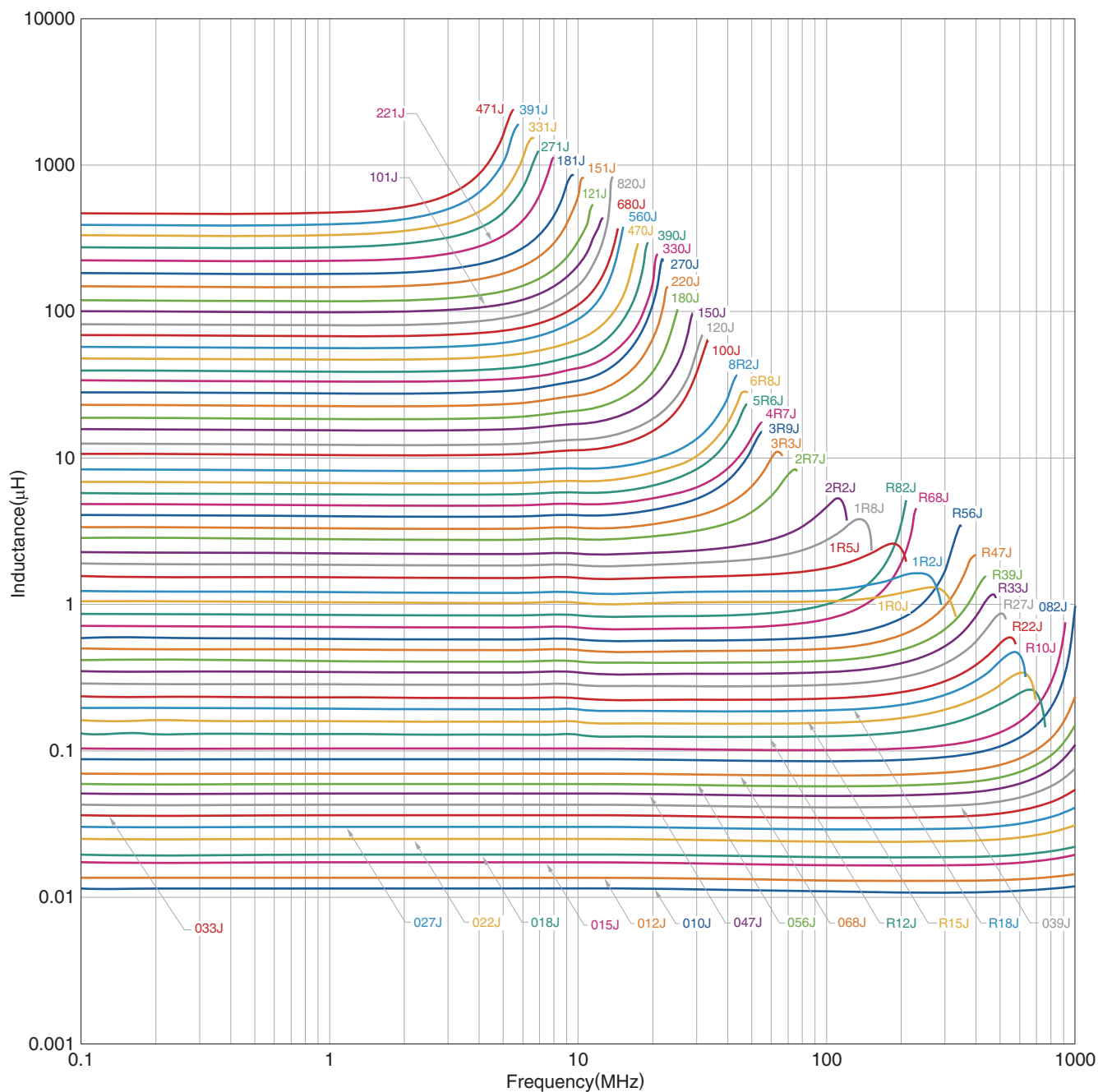

Measurement equipment

Product No.	Manufacturer
4294A	Keysight Technologies

* Equivalent measurement equipment may be used.

NLV32-EFD type

SHAPE & DIMENSIONS

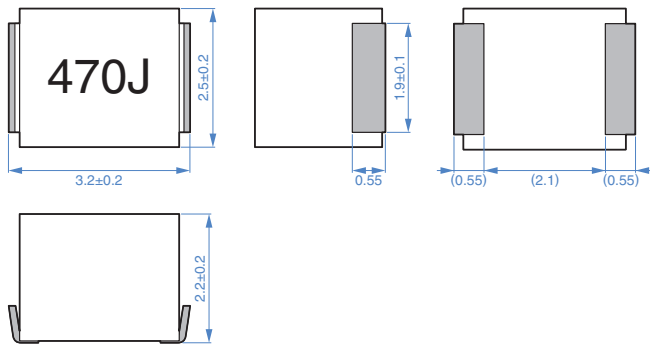

Dimensions in mm

PACKAGING STYLE

REEL DIMENSIONS

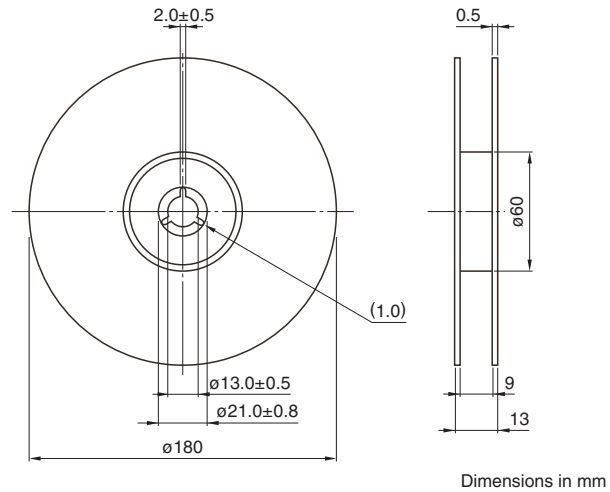

Dimensions in mm

RECOMMENDED LAND PATTERN

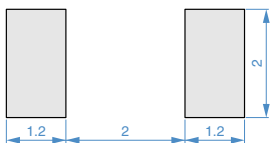

Dimensions in mm

TAPE DIMENSIONS

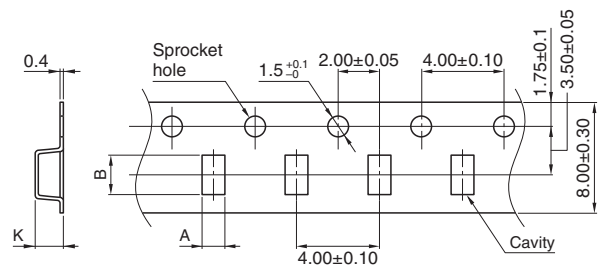

Dimensions in mm

Type	A	B	K
NLV32-EFD	2.8	3.5	2.3

RECOMMENDED REFLOW PROFILE

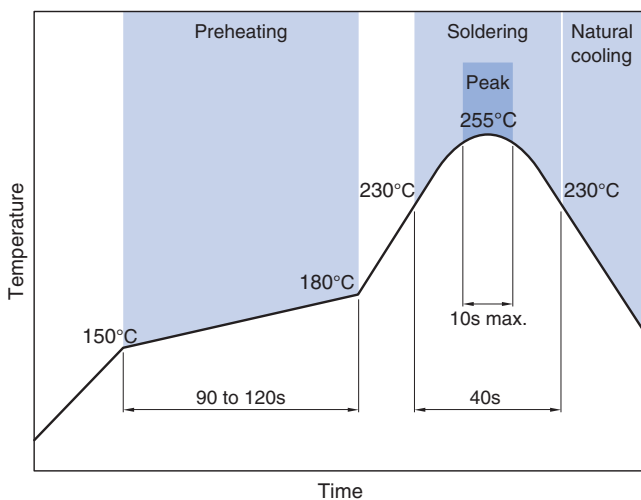

PACKAGE QUANTITY

Package quantity	2000 pcs/reel
------------------	---------------

TEMPERATURE RANGE, INDIVIDUAL WEIGHT

Operating temperature range*	Storage temperature range**	Individual weight
-40 to +105 °C	-40 to +105 °C	50 mg

* Operating temperature range includes self-temperature rise.

** The storage temperature range is for after the assembly.

REMINDERS FOR USING THESE PRODUCTS

Before using these products, be sure to request the delivery specifications.

SAFETY REMINDERS

Please pay sufficient attention to the warnings for safe designing when using this products.

REMINDERS

- The storage period is less than 6 months. Be sure to follow the storage conditions (temperature: 5 to 40°C, humidity: 10 to 75% RH or less).
If the storage period elapses, the soldering of the terminal electrodes may deteriorate.
- Do not use or store in locations where there are conditions such as gas corrosion (salt, acid, alkali, etc.).
- Before soldering, be sure to preheat components.
The preheating temperature should be set so that the temperature difference between the solder temperature and chip temperature does not exceed 150°C.
- Soldering corrections after mounting should be within the range of the conditions determined in the specifications.
If overheated, a short circuit, performance deterioration, or lifespan shortening may occur.
- When embedding a printed circuit board where a chip is mounted to a set, be sure that residual stress is not given to the chip due to the overall distortion of the printed circuit board and partial distortion such as at screw tightening portions.
- Self heating (temperature increase) occurs when the power is turned ON, so the tolerance should be sufficient for the set thermal design.
- Carefully lay out the coil for the circuit board design of the non-magnetic shield type.
A malfunction may occur due to magnetic interference.
- Use a wrist band to discharge static electricity in your body through the grounding wire.
- Do not expose the products to magnets or magnetic fields.
- Do not use for a purpose outside of the contents regulated in the delivery specifications.
- The products listed on this catalog are intended for use in general electronic equipment (AV equipment, telecommunications equipment, home appliances, amusement equipment, computer equipment, personal equipment, office equipment, measurement equipment, industrial robots) under a normal operation and use condition.
The products are not designed or warranted to meet the requirements of the applications listed below, whose performance and/or quality require a more stringent level of safety or reliability, or whose failure, malfunction or trouble could cause serious damage to society, person or property.
If you intend to use the products in the applications listed below or if you have special requirements exceeding the range or conditions set forth in the each catalog, please contact us.

- (1) Aerospace/aviation equipment
- (2) Transportation equipment (electric trains, ships, etc.)
- (3) Medical equipment
- (4) Power-generation control equipment
- (5) Atomic energy-related equipment
- (6) Seabed equipment
- (7) Transportation control equipment

- (8) Public information-processing equipment
- (9) Military equipment
- (10) Electric heating apparatus, burning equipment
- (11) Disaster prevention/crime prevention equipment
- (12) Safety equipment
- (13) Other applications that are not considered general-purpose applications

When designing your equipment even for general-purpose applications, you are kindly requested to take into consideration securing protection circuit/device or providing backup circuits in your equipment.