

Description

The FERD30SM100S is based on a proprietary technology that achieves the best in class V_F/I_R trade-off for a given silicon surface.

This 100 V rectifier has been optimized for use in confined applications where both efficiency and thermal performance are key.

Table 1. Device summary

Symbol	Value
$I_{F(AV)}$	30 A
V_{RRM}	100 V
T_j (max)	+175 °C
V_F (typ)	0.39 V

Features

- ST proprietary process
- Reduce leakage current
- Low forward voltage drop
- High frequency operation
- ECOPACK[®]2 compliant component

1 Characteristics

Table 2. Absolute ratings (limiting values, at 25 °C, unless otherwise specified, anode terminals short-circuited)

Symbol	Parameter	Value	Unit
V_{RRM}	Repetitive peak reverse voltage	100	V
$I_{F(RMS)}$	Forward rms current	60	A
$I_{F(AV)}$	Average forward current, $\delta = 0.5$	$T_c = 130\text{ °C}$ 30	A
I_{FSM}	Surge non repetitive forward current	$t_p = 10\text{ ms}$ sinusoidal 250	A
T_{stg}	Storage temperature range	-65 to + 175	°C
$T_j^{(1)}$	Maximum operating junction temperature	175	°C

1. $\frac{dP_{tot}}{dT_j} < \frac{1}{R_{th(j-a)}}$ condition to avoid thermal runaway for a diode on its own heatsink.

Table 3. Thermal resistance

Symbol	Parameter	Value (max)	Unit
$R_{th(j-c)}$	Junction to case	1.6	°C/W

Table 4. Static electrical characteristics (anode terminals short-circuited)

Symbol	Parameter	Test conditions	Min.	Typ.	Max.	Unit
$I_R^{(1)}$	Reverse leakage current	$T_j = 25\text{ °C}$	-	-	150	μA
		$T_j = 125\text{ °C}$			8	
		$T_j = 125\text{ °C}$	$V_R = 70\text{ V}$	-	-	9
$V_F^{(2)}$	Forward voltage drop	$T_j = 25\text{ °C}$	-	-	0.475	V
		$T_j = 125\text{ °C}$			0.39	
		$T_j = 25\text{ °C}$	-	-	0.585	
		$T_j = 125\text{ °C}$			0.50	
		$T_j = 25\text{ °C}$	-	-	0.95	
		$T_j = 125\text{ °C}$			0.64	

1. Pulse test: $t_p = 5\text{ ms}$, $\delta < 2\%$

2. Pulse test: $t_p = 380\text{ }\mu\text{s}$, $\delta < 2\%$

To evaluate the conduction losses use the following equation:

$$P = 0.56 \times I_{F(AV)} + 0.005 I_{F(RMS)}^2$$

Figure 1. Average forward power dissipation versus average forward current

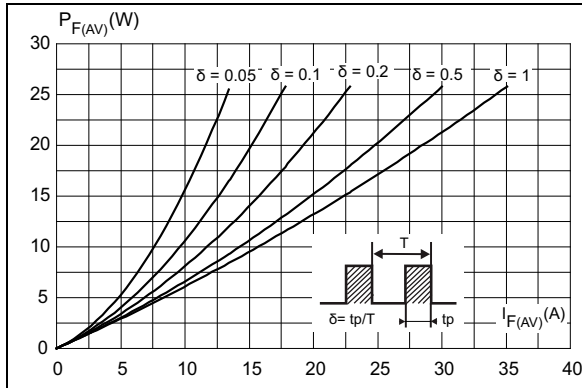

Figure 2. Average forward current versus ambient temperature ($\delta = 0.5$)

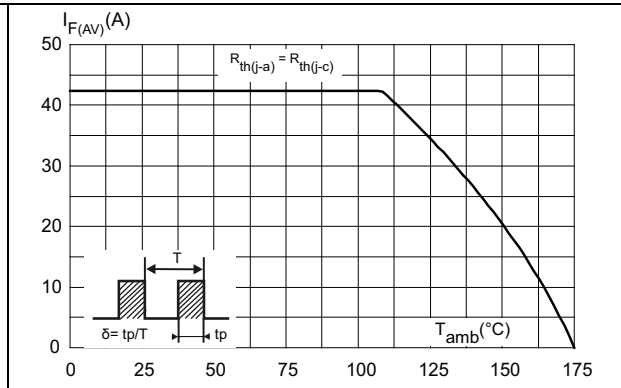

Figure 3. Relative variation of thermal impedance junction to case versus pulse duration

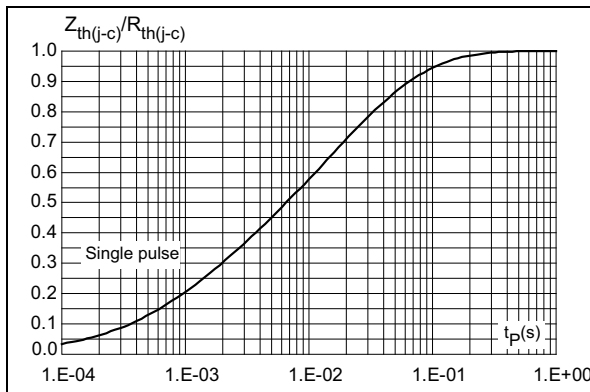

Figure 4. Reverse leakage current versus reverse voltage applied (typical values)

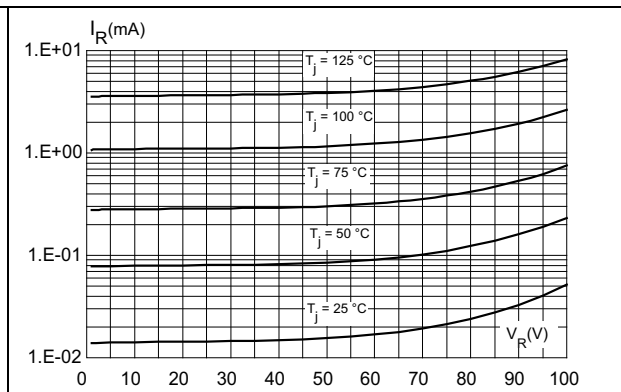

Figure 5. Junction capacitance versus reverse voltage applied (typical values)

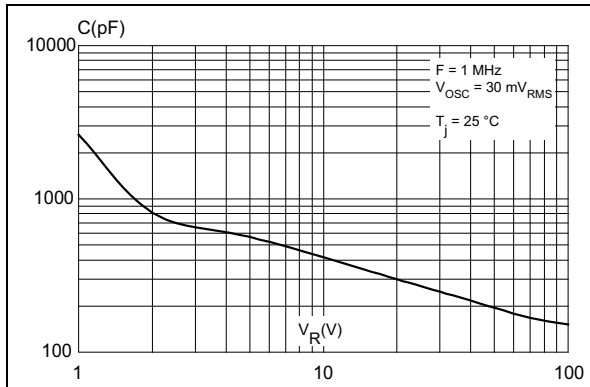
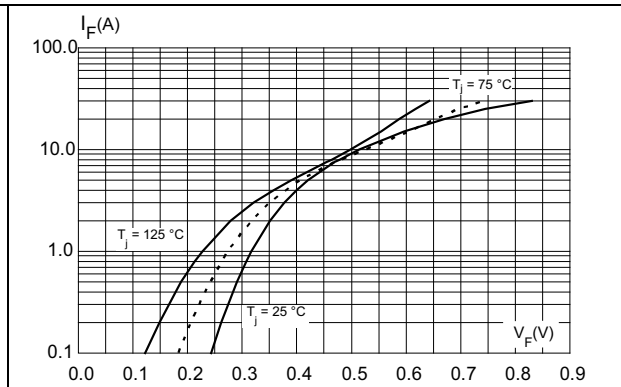

Figure 6. Forward voltage drop versus forward current (typical values)



2 Package information

- Epoxy meets UL94, V0
- Cooling method: by conduction (C)
- Recommended torque value: 0.55 N·m
- Maximum torque value: 0.77 N·m

In order to meet environmental requirements, ST offers these devices in different grades of ECOPACK® packages, depending on their level of environmental compliance. ECOPACK® specifications, grade definitions and product status are available at: www.st.com. ECOPACK® is an ST trademark.

Figure 7. TO-220AB dimension definitions

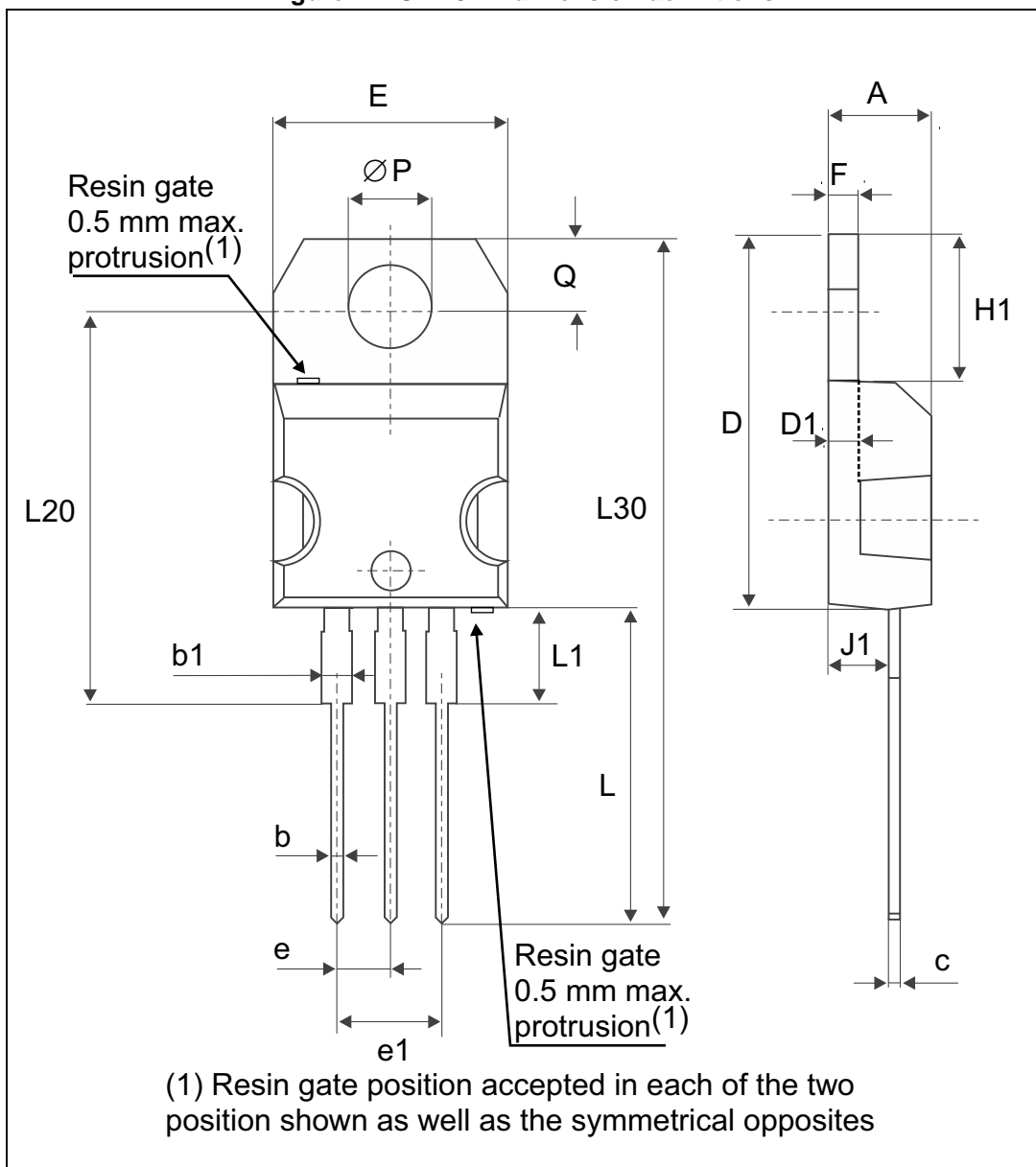

Table 5. TO-220AB dimension values

Ref.	Dimensions			
	Millimeters		Inches	
	Min.	Max.	Min.	Max.
A	4.40	4.60	0.17	0.18
b	0.61	0.88	0.024	0.035
b1	1.14	1.70	0.045	0.067
c	0.48	0.70	0.019	0.027
D	15.25	15.75	0.60	0.62
D1	1.27 typ.		0.05 typ.	
E	10	10.40	0.39	0.41
e	2.40	2.70	0.094	0.106
e1	4.95	5.15	0.19	0.20
F	1.23	1.32	0.048	0.052
H1	6.20	6.60	0.24	0.26
J1	2.40	2.72	0.094	0.107
L	13	14	0.51	0.55
L1	3.50	3.93	0.137	0.154
L20	16.40 typ.		0.64 typ.	
L30	28.90 typ.		1.13 typ.	
ØP	3.75	3.85	0.147	0.151
Q	2.65	2.95	0.104	0.116

3 Ordering information

Table 6. Ordering information

Order code	Marking	Package	Weight	Base qty	Delivery mode
FERD30SM100ST	FERD30SM100ST	TO-220AB	1.9 g	50	Tube

4 Revision history

Table 7. Document revision history

Date	Revision	Changes
12-Jan-2015	1	Initial release.

IMPORTANT NOTICE – PLEASE READ CAREFULLY

STMicroelectronics NV and its subsidiaries ("ST") reserve the right to make changes, corrections, enhancements, modifications, and improvements to ST products and/or to this document at any time without notice. Purchasers should obtain the latest relevant information on ST products before placing orders. ST products are sold pursuant to ST's terms and conditions of sale in place at the time of order acknowledgement.

Purchasers are solely responsible for the choice, selection, and use of ST products and ST assumes no liability for application assistance or the design of Purchasers' products.

No license, express or implied, to any intellectual property right is granted by ST herein.

Resale of ST products with provisions different from the information set forth herein shall void any warranty granted by ST for such product.

ST and the ST logo are trademarks of ST. All other product or service names are the property of their respective owners.

Information in this document supersedes and replaces information previously supplied in any prior versions of this document.

© 2015 STMicroelectronics – All rights reserved

