

BME280

Combined humidity and pressure sensor



BME280

Document revision

1.8

Document release date

29 May 2018

Document number

BST-BME280-HS006-00

Technical reference
code(s)

0 273 141 185

Notes

Data in this document are subject to change without notice. Product photos and pictures are for illustration purposes only and may differ from the real product's appearance.

Handling, soldering & mounting instructions

This document describes the conditions and parameters to be applied when handling, soldering and mounting the BME280 to a PCB.

Important:

- In order to avoid any damages of the BME280 and resultant loss of warranty please strictly keep with the instructions described within this document.
- It is also strongly recommended to study the BME280 data sheet prior to handling the BME280 sensor device.
- In case you have any questions, please do not hesitate to contact your nearest Bosch Sensortec representative for further advice.

Index of Contents

1. Package outline dimensions.....	5
1.1. Top view.....	5
2. Device marking.....	6
2.1. Mass production devices	6
2.2. Engineering samples	6
3. Moisture sensitivity level and soldering	7
3.1. MSL and device storage	7
3.2. Multiple reflow soldering cycles	7
3.3. Reconditioning Procedure	8
3.4. Classification reflow profile	8
4. Environmental safety.....	10
4.1. RoHS compliancy.....	10
4.2. Halogen content	10
4.3. Internal package structure	10
5. Mounting recommendations	10
5.1. Recommendation details for the humidity measurement.....	11
5.2. Thermal coupling of the sensor element	14
5.3. Additional recommendation details	15
5.4. Push-button contacts.....	17
5.5. Hot-spots on the PCB.....	18
5.6. PCB anchor points.....	18
5.7. Resin coatings.....	19
5.8. Minimum distance between Sensor and PCB.....	19
5.9. Underfill and cleaning materials.....	20

- 5.10. Redundant PCB anchor points.....21
- 5.11. Mechanical stress maximum on the PCB.....21
- 6. Legal disclaimer22**
 - 6.1. Engineering samples22
 - 6.2. Product use22
 - 6.3. Application examples and hints22
- 7. Document history and modification23**

1. Package outline dimensions

The sensor housing is a standard 8-pin LGA package with metal lid with a vent hole for pressure and humidity supply. Its dimensions are **2.5 mm (±0.1 mm) × 2.5 mm (±0.1 mm) × 0.95 mm (±0.05 mm)**.

Note: All dimensions are in mm. If not specified otherwise, tolerances are ±0.05 mm, ±1°.

1.1. Top view

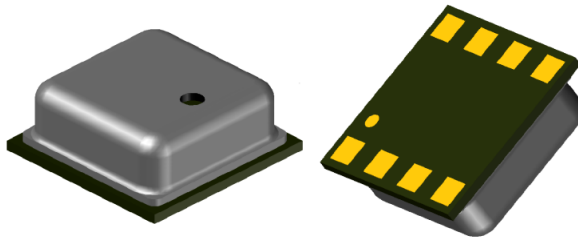
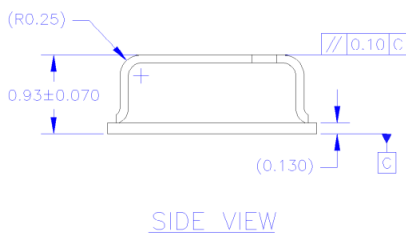
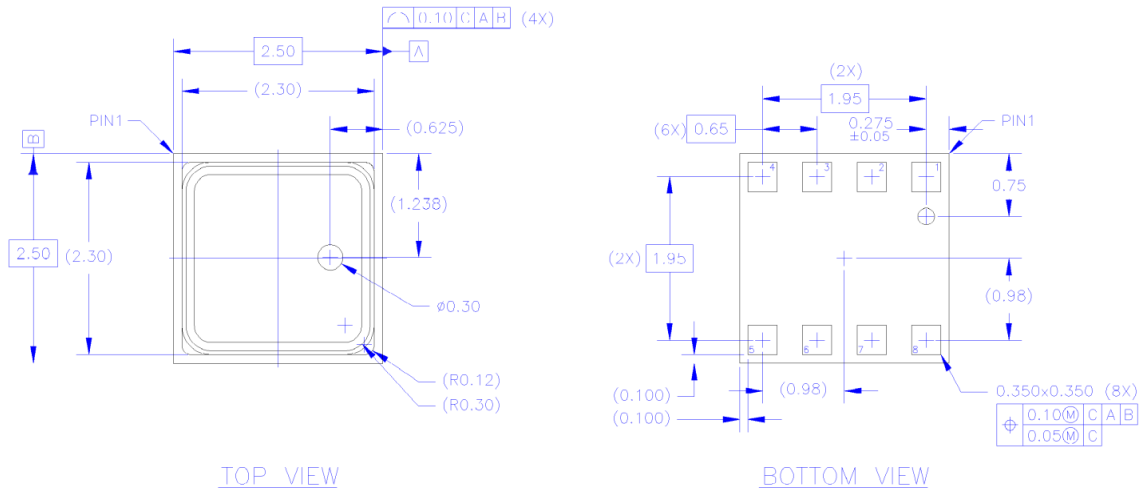

PACKAGE TYPE CAVITY MEMS	BODY X 2.50	BODY Y 2.50	BODY Z 1.00(MAX)
LGA PITCH 0.65	LGA SIZE 0.350X0.350	LGA COUNT 8	BALL MATRIX N/A

UNLESS OTHERWISE SPECIFIED DIMENSIONS ARE IN MILLIMETERS

DECIMAL ANGULAR
X.X ±0.1 ±1°
X.XX ±0.05
X.XXX ±0.030

INTERPRET DIM AND TOL PER
ASME Y14.5M - 1994

2. Device marking

The BME280 device lid shows the following laser-marking:

2.1. Mass production devices

Table 1: Marking of mass production samples

Marking	Symbol	Description
	CCC	<u>Lot counter</u> : 3 alphanumeric digits, variable to generate mass production trace-code
	T	<u>Product number</u> : 1 alphanumeric digit, fixed to identify product type, T = "U" "U" is associated with the product BME280 (part number 0 273 141 185)
	L	<u>Sub-contractor ID</u> : 1 alphanumeric digit, variable to identify sub-contractor (L = "P")

2.2. Engineering samples

Table 2: Marking of engineering samples

Marking	Symbol	Description
	XX	<u>Sample ID</u> : 2 alphanumeric digits, variable to generate trace-code
	N	<u>Eng. Sample ID</u> : 1 alphanumeric digit, fixed to identify engineering sample, N = "*" or "e" or "E"
	CC	<u>Counter ID</u> : 2 alphanumeric digits, variable to generate trace-code

3. Moisture sensitivity level and soldering

3.1. MSL and device storage

The BME280 is classified as MSL 1 (moisture sensitivity level) according to IPC/JEDEC standards J-STD-020C and J-STD-033A.

The device can be soldered Pb-free with a peak temperature of 260°C for 20 to 40 sec. The minimum height of the solder after reflow shall be at least 50µm. This is required for a good mechanical decoupling between sensor device and the printed circuit board (PCB).

Note: When designing the solder paste silk print opening window, avoid excess solder paste to allow good reflow.

To ensure good solder-ability, the devices shall be stored at room temperature (20°C).

The soldering process can lead to an offset shift. The physical origin of this shift is not material aging but mechanical hysteresis frozen in by the soldering temperature cycle.

Manual unsoldering can lead to further offset shift, especially if the soldering temperature and / or soldering time is above the given values of 260°C and 40 sec.

Avoid contact of the device with liquids.

3.2. Multiple reflow soldering cycles

The BME280 can withstand in total up to 3 reflow soldering cycles.

This could be a situation where a PCB is mounted with devices from both sides (i.e. 2 reflow cycles necessary) and where in the next step an additional re-work cycle could be required (1 reflow).

The specified solder drift is valid for up to 3 reflow cycles. Please see the datasheet for more details.

3.3. Reconditioning Procedure

After exposing the device to operating conditions, which exceed the limits specified in the datasheet, e.g. after reflow, the humidity sensor may possess an additional offset. Therefore the following reconditioning procedure is mandatory to restore the calibration state:

1. Dry-Baking: 120 °C at <5% rH for 2 h
2. Re-Hydration: 70 °C at 75% rH for 6 h
3. Rest period: for one hour at room temperature

or alternatively

1. Dry-Baking: 120 °C at <5% rH for 2 h
2. Re-Hydration: 25 °C at 75% rH for 24 h
3. Rest period: for one hour at room temperature

or alternatively after solder reflow only

1. Do not perform Dry-Baking
2. Ambient Re-Hydration: ~25 °C at >40% rH for >5d

3.4. Classification reflow profile

The following figure describes the recommended reflow soldering process.

Vapor phase soldering has to be avoided.

Please note: Dry-baking of the BME280 prior to soldering is not allowed and not needed due to MSL1.

Profile Feature		Pb-Free Assembly
Average Ramp-Up Rate ($T_{S_{max}}$ to T_p)		3° C/second max.
Preheat - Temperature Min ($T_{S_{min}}$) - Temperature Max ($T_{S_{max}}$) - Time ($t_{S_{min}}$ to $t_{S_{max}}$)		150 °C 200 °C 60-180 seconds
Time maintained above: - Temperature (T_L) - Time (t_L)		217 °C 60-150 seconds
Peak/Classification Temperature (T_p)		260 °C
Time within 5 °C of actual Peak Temperature (t_p)		20-40 seconds
Ramp-Down Rate		6 °C/second max.
Time 25 °C to Peak Temperature		8 minutes max.

Note 1: All temperatures refer to topside of the package, measured on the package body surface.

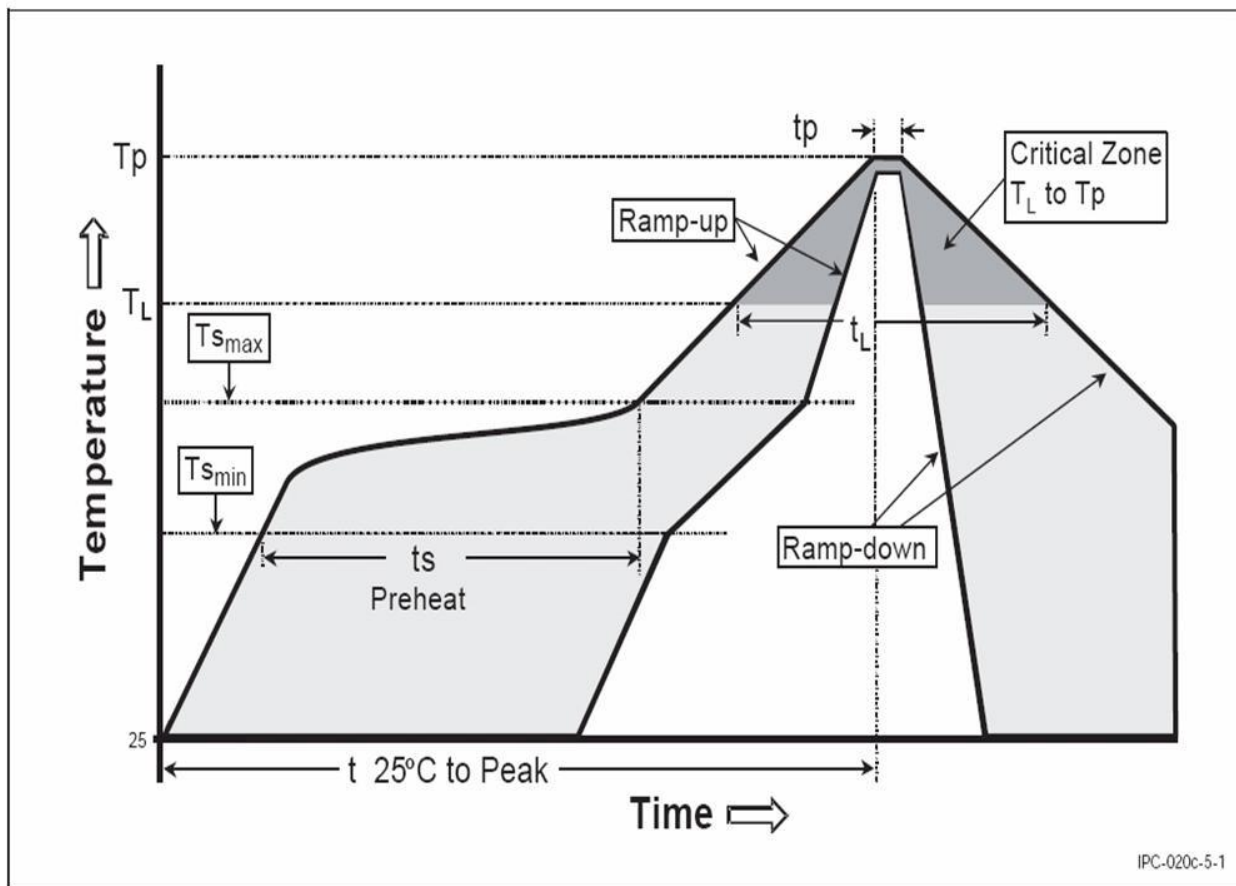

IPC-020c-5-1

4. Environmental safety

4.1. RoHS compliancy

The BME280 sensor meets the requirements of the EC directive “Restriction of hazardous substances (RoHS)”, see also:

“Directive 2002/95/EC of the European Parliament and of the Council of 11 September 2002 on the restriction of the use of certain hazardous substances in electrical and electronic equipment”.

The BME280 is also Lead(Pb)-free and halogen-free.

4.2. Halogen content

The BME280 is halogen-free. For more details on the analysis results please contact your Bosch Sensortec representative.

4.3. Internal package structure

Within the scope of Bosch Sensortec’s ambition to improve its products and secure the mass product supply, Bosch Sensortec qualifies additional sources (e.g. 2nd source) for the LGA package of the BME280.

While Bosch Sensortec took care that all of the technical packages parameters are described above are 100% identical for all sources, there can be differences in the chemical content and the internal structural between the different package sources.

However, as secured by the extensive product qualification process of Bosch Sensortec, this has no impact to the usage or to the quality of the BME280 product.

5. Mounting recommendations

MEMS sensors in general are high-precision measurement devices which consist of electronic as well as mechanical silicon structures. Bosch Sensortec MEMS sensor devices are designed for precision, efficiency and mechanical robustness.

However, in order to achieve best possible results for your design, the following recommendations should be taken into consideration when mounting combined humidity and pressure sensor on a printed-circuit board (PCB).

5.1. Recommendation details for the humidity measurement

The following chapter presents guidelines about the design of the housing and the placement of the BME280 on the PCB to get accurate measurements at a fast response time for the humidity part. Deviations of temperature and the relative humidity (RH) between the sensor and the environment should be avoided. This can be realized by thermal decoupling of the device within the PCB and coupling of the sensor to the environmental conditions.

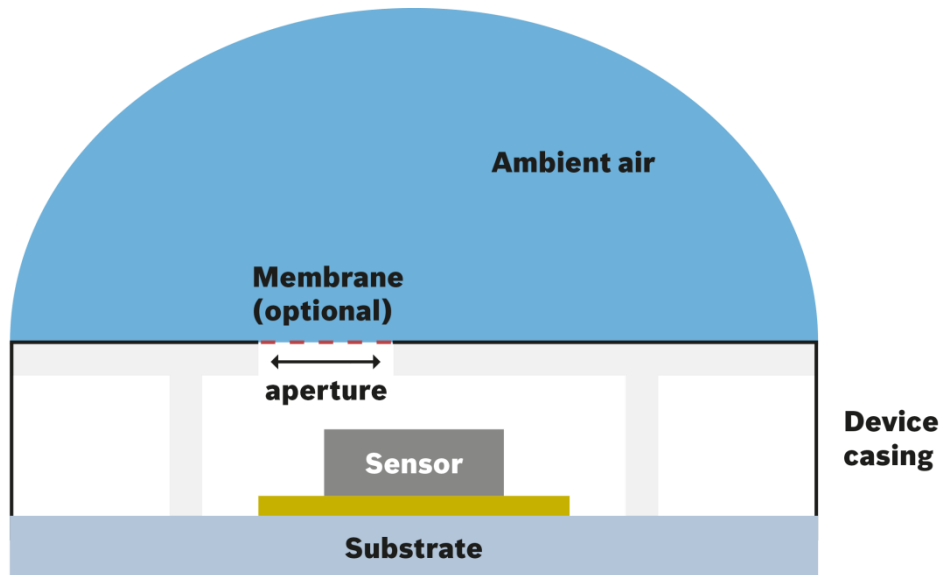

Figure 1: Deviations of temperature and relative humidity has to be minimized to get accurate measurement

Following guidelines are recommended to avoid heating of the BME280 within the smartphone

- The sensor should be not more than 10% in the active state to avoid self heating, please check the datasheet for more details how to minimize the power consumption at a particular resolution
- Thermal decoupling of the sensor will assure that heat conduction takes place between heat sources and the sensor

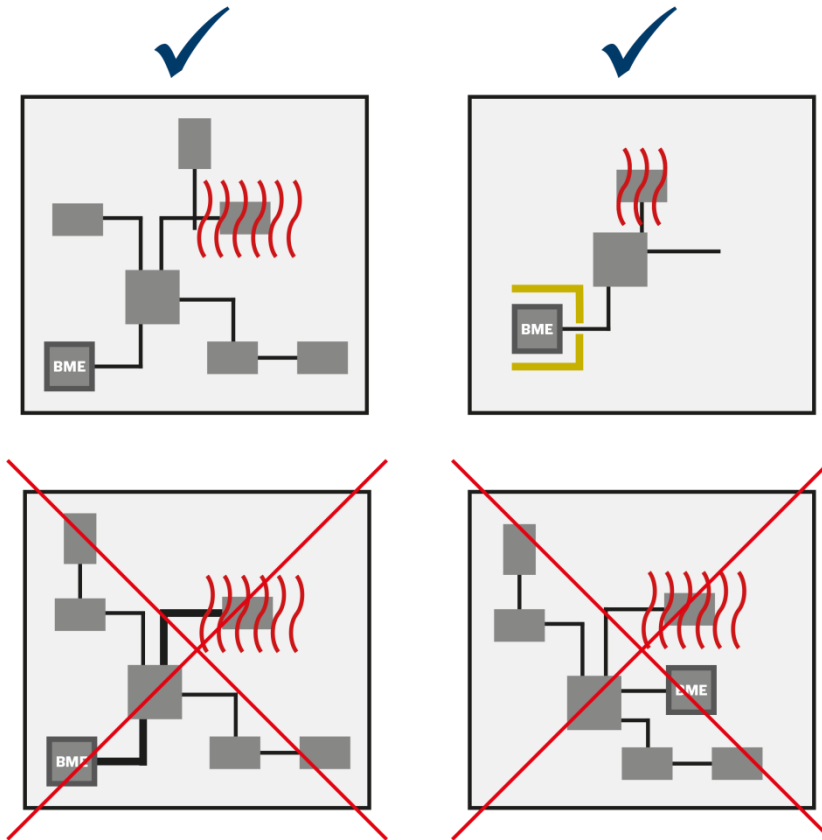

Figure 2: Minimize the thickness of the metal interconnections with adequate distance to heat sources (like μC) to circumvent heat conduction (left top). Trenches (yellow lines) around the sensor minimizes thermal conduction throughout the PCB (top right). Thick metal interconnections will enhance heat transport from a heat source to the sensor and should be avoided (left bottom). Heat sources close to the sensor will heat-up the sensor (bottom right).

- Protect the sensor from heated air to avoid convection and radiation which leads to warming-up

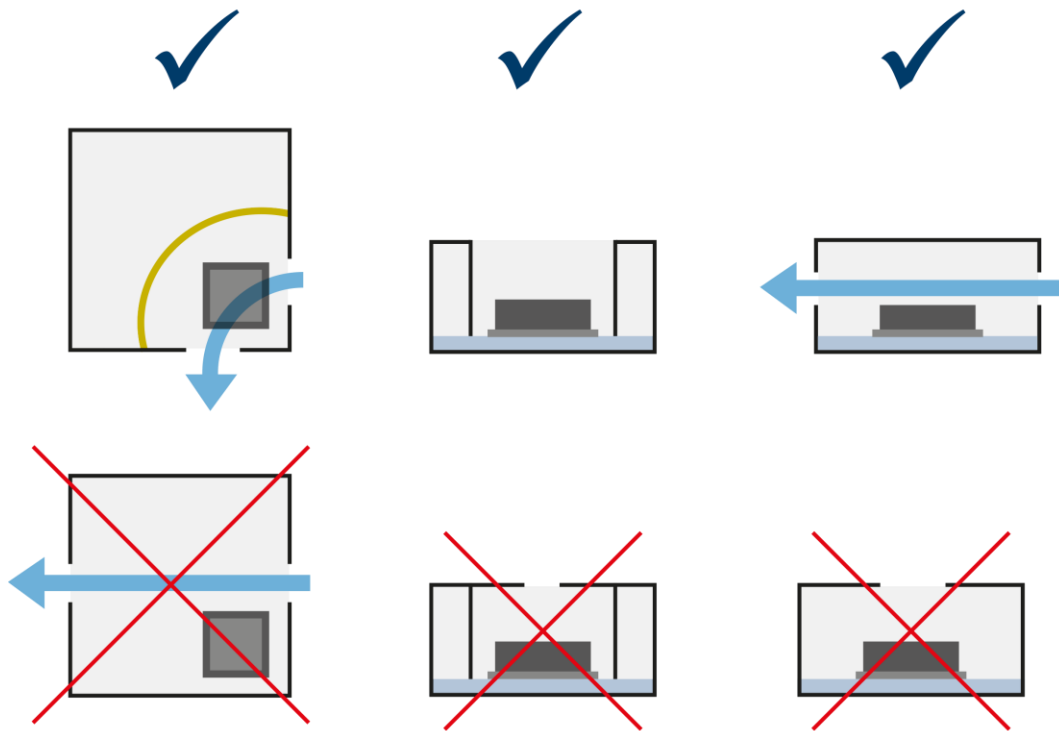

Figure 3: Shielding of the sensor from heat sources by means of a barrier within the housing minimizes heat convection (top left). Small dead volume is realized by barriers in the housing combined with a large aperture (top middle). Placement of the sensor with a defined air flow over the sensor minimizes the temperature deviations between sensor and the environment (top right). It is not recommended to have a large dead volume if the air flow is not defined and doesn't strike the sensor (bottom left). Small aperture compared to the dead volume doesn't ensure an accurate air circulation (bottom middle). Large dead volumes have to be minimized (bottom right).

Wrong placement can also lead to inaccurate measurement of the relative humidity due to delayed response time. Therefore some simple guidelines will accomplish a fast response time:

- Placement of the sensor as close as possible to the environmental air
- Single opening is not the optimum solution compared to a defined air flow over the sensor
- Dead volume must be minimized
- Large aperture is preferred
- Use of port protection will reduce the response time
- Usage of material within the dead volume which is susceptible to moisture has to be avoided
- Vent hole of application and air flow have same direction
- Air flow (breath) must be directed along the z-axis straight at the sensor lid

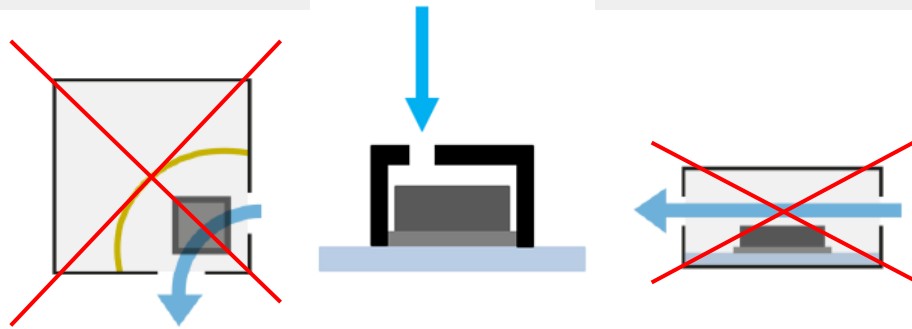

Figure 4: A fast response time can only be ensured by directing the air flow (breath) straight along z-axis onto the sensor lid of the BME280 and a gasket/rubber (in black) is added (top middle). This implies that vent hole and air flow must have same direction. The other two shown scenarios (top left and top right) may cause a lower response time.

5.2. Thermal coupling of the sensor element

The BME280 has a specific thermal mass. Therefore the temperature of the BME280 reacts very slowly on changes of the environmental temperature. There are some methods to realize fast temperature response times like

- Strong thermal coupling of the sensor to the environment.

Careful placement of the sensor is very important to achieve the best temperature measurement. Excellent thermal coupling between the sensor and the environment the sensor is guaranteed with placement of the sensor as close as possible to the environment (ambient air). Position at the corner or pretty close to the edge of the device is favorable. Air flow of ambient air will additionally enhance the thermal coupling.

- Weak thermal coupling of the sensor to the thermal mass of the housing and board (PCB)

Minimized coupling of the sensor and the housing and board (PCB) is assured if the heat conduction is decreased as described in section 5.1.

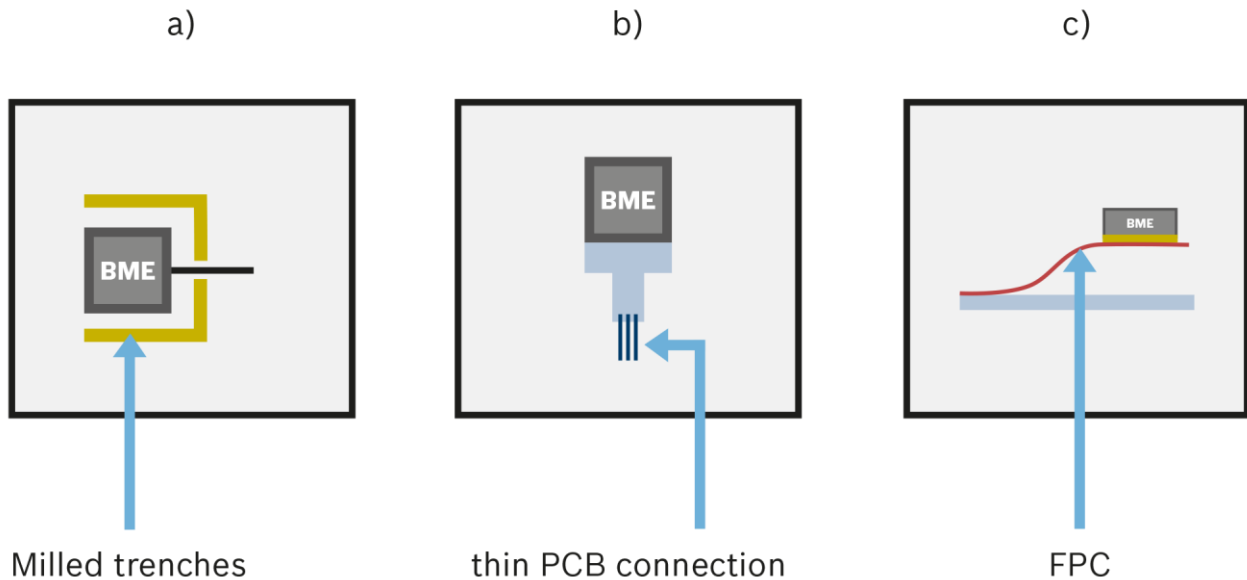

Figure 5: Thermal decoupling of the sensor from the PCB by means of milled trenches (a) or small PCB connections (b).

5.3. Additional recommendation details

- Please avoid rear side handling of the BME280 sensor, otherwise the device can be destroyed
- It is generally recommended to keep a reasonable distance between the sensor mounting location on the PCB and the critical points described in the following examples. The exact value for a “reasonable distance” depends on many customer specific variables and must therefore be determined case by case
- It is not recommended to place the sensor directly under or next to push-button contacts as this can result in mechanical stress
- It is not recommended to place the sensor close to the edge of the PCB
- It is not recommended to place the sensor in direct vicinity of extremely hot spots (e.g. a μ Controller) as this can result in heating-up the sensor
- Do not mount the sensor too close to a PCB anchor point, where the PCB is attached to a shelf (or similar) as this could also result in mechanical stress
- Please avoid total or partial coverage of the sensor by any kind of (epoxy) resin, as this can possibly result in mechanical stress and could clog the hole in the sensor’s top lid
- The clearance above the metal lid of the BME280 shall be 0.1mm at minimum
- For the device housing appropriate venting needs to be provided in case the ambient pressure shall be measured
- The sensor has to be protected against all kinds of liquids, during processing (e.g. solder flux, cleaning agents) and during operation, strong air blasts from an air-pistol (not oil-free air) are also forbidden. Applying liquids, cleaning agents or solder flux to the sensor may cause to drift of the reading or complete malfunction of the sensor. Low viscose coatings or potting materials can enter the sensor hole, get onto the MEMS sensor chip and damage the sensor element (pressure and/or humidity).

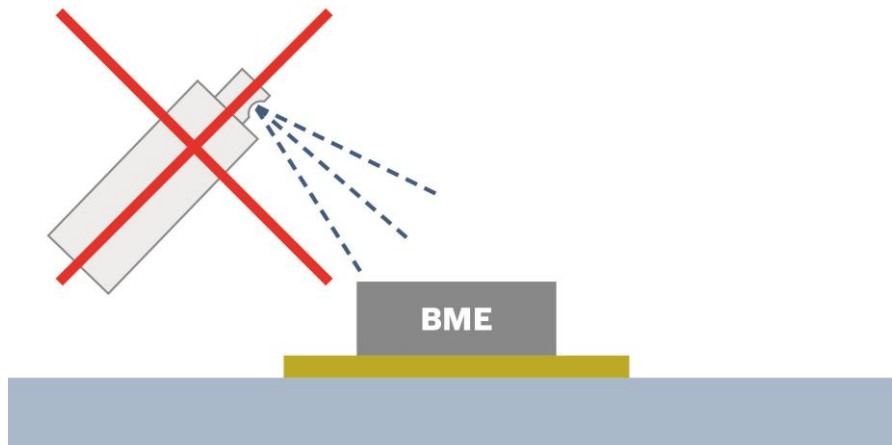

Figure 6: Do not apply spray to the BME without port protection

- It is recommended to cover the hole of the device with a protective cover during processing to avoid contamination of the MEMS sensors with all kind of liquids, dust, e.g. kapton tape during assembly, e.g. cleaning, soldering. No board wash is applied once the sensor is assembled to the PCB w/o protection of the sensor hole

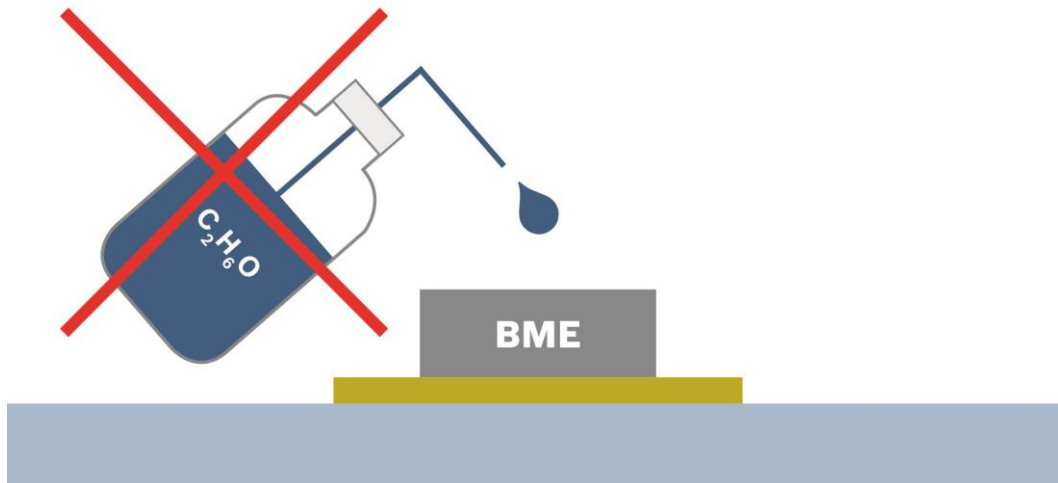

Figure 7: Do not apply liquids to the BME without port protection

- Forbidden is the exposure to chemicals. It shall be avoided that the sensor gets in close contact with volatile chemicals such as solvents or other organic compounds in high concentration and long exposure. Toluene, Acetone, Ethanol, Ketenes Isopropyl Alcohol, etc. are identified to effect drift of the humidity reading – permanent damage of the sensor readings is very likely in most of these cases. It is important to know that the referred materials to are ingredients for adhesives, epoxies, glues, etc. and outgassing during re-conditioning baking and curing. These chemicals are also added as plasticizers into plastics, used for packaging materials, and outgassing for a limited time. Bases and acids can damage the sensor permanently and shall be kept away from the sensor. Examples for such chemicals are NH_3 , NaOH , HCl , H_2SO_4 , HF , HNO_3 , $\text{H}_2\text{S}_2\text{O}_7$ etc. Additionally O_3 in high concentration or H_2O_2 have the same effect and is not recommended.
- The reason to protect against exposure of the sensor to chemicals leads to the recommendation to store the sensors in original packing including the sealed ESD bag at following conditions : Temperature shall be in the range of 10~50 °C and humidity at 20%~60 %rH

- The BME280 sensor is sensitive to light, which can influence the accuracy of the measurement. Therefore, the hole in the top lid shall not be exposed to direct light during operation
- The BME280 shall not be placed close to fast heating parts. In case of temperature changes $> 3.0^{\circ}\text{C}/\text{sec}$ during operation. It is recommended to follow Bosch Sensortec application note BST-BMP280-AN004, "Correction of errors induced by fast temperature changes". Please contact your Bosch Sensortec representative for details
- During handling of the BME280, especially in case parts are handled manually, make sure that no objects, like for example tweezers tips or other sharp objects do get inside of the vent hole of the sensor. This could damage the device
- Ultrasonic welding: ultrasonic welding can induce damage in the pressure sensor. Customer – in case of using this process in his manufacturing line – has to secure the parameter of the process for each project individually to protect the pressure sensor
- Vapor phase soldering: connecting BME280 on the PCB through vapor phase soldering might cause deposits on the diaphragm which can distort the electrical signal

In case you have any questions with regard to the mounting of the sensor on your PCB, do not hesitate to contact us.

The scenarios described below – given as examples – may lead to a bending of the PCB, which as a consequence, might influence the performance of a sensor mounted on the PCB.

Please note that this possible behavior is not limited to Bosch Sensortec devices, but may as well occur with 3rd party MEMS devices in a similar manner.

5.4. Push-button contacts

Keep a reasonable distance to push-button contacts, when placing the sensor device. Do not position the sensor directly beneath a push-button contact.

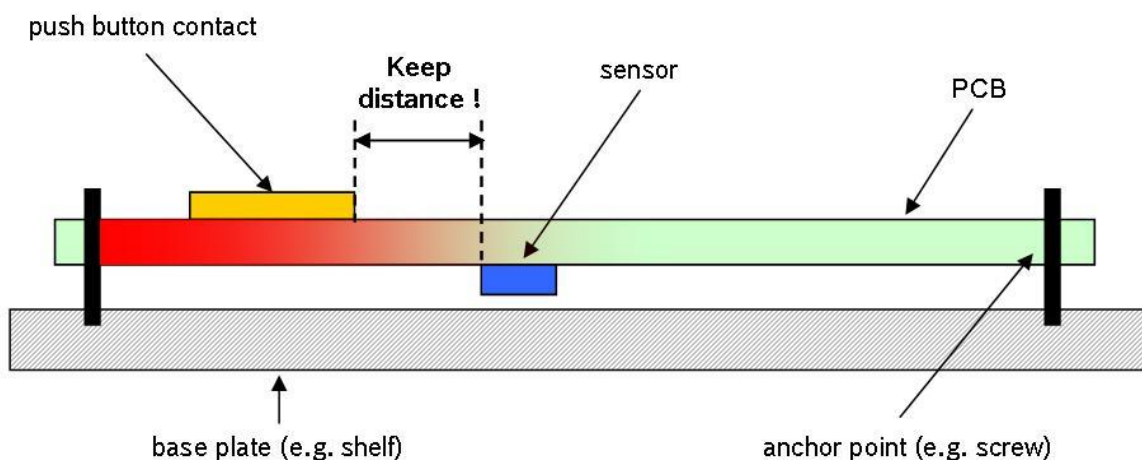

5.5. Hot-spots on the PCB

Keep a reasonable distance from any hot spots, when placing the sensor device. Hot spots can be for example other integrated circuits with high power consumption.

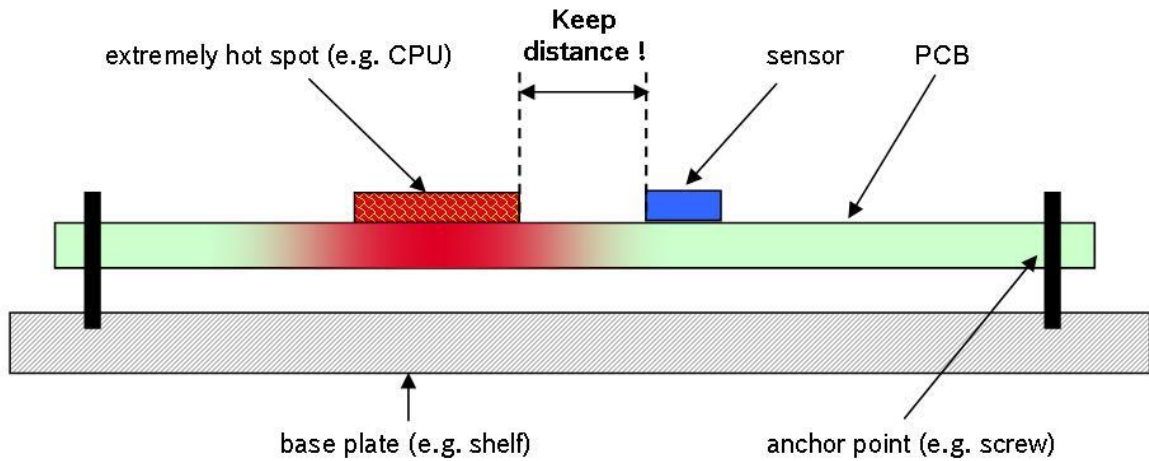

5.6. PCB anchor points

Please keep a reasonable distance from any anchor points, where the PCB is fixed at a base plate (e.g. like a shelf or similar), when placing the sensor device.

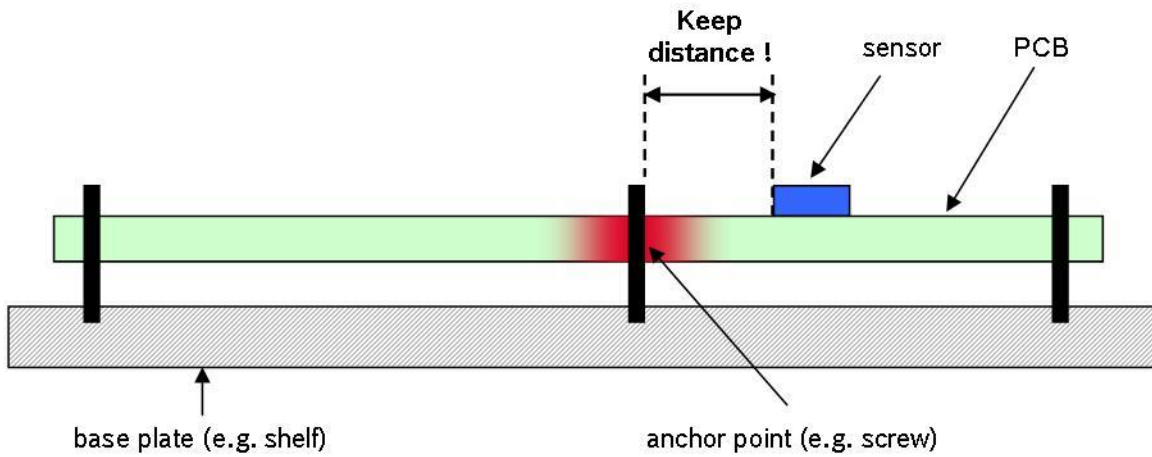

5.7. Resin coatings

Please avoid total and partial covering of the BME280 sensor with any protective material like for example epoxy resin.

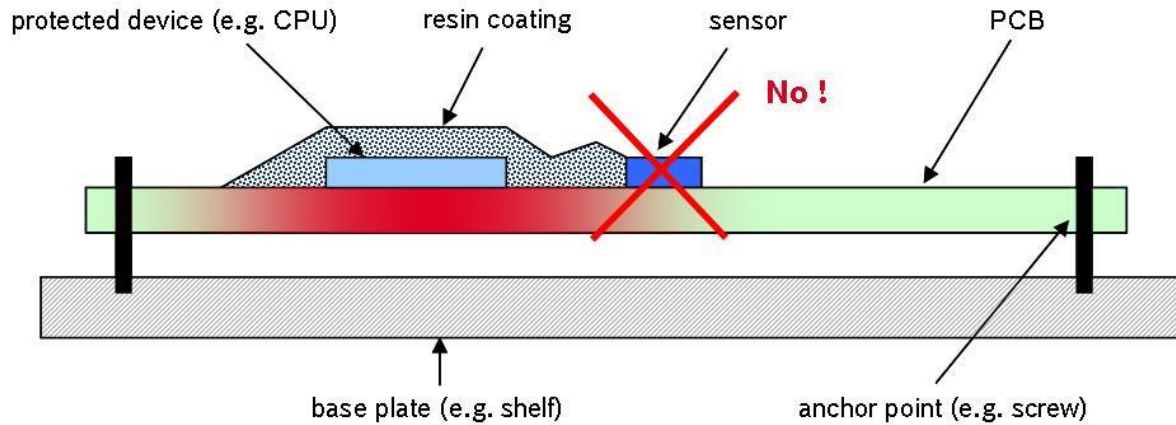

As shown in the above figure, please take care that the sensor is not covered and not in contact with any (epoxy) resin material leading to an un-symmetric stress distribution over the sensor package.

5.8. Minimum distance between Sensor and PCB

The distance between the sensor and the PCB after the soldering process must be at least 50 μ m.

5.9. Underfill and cleaning materials

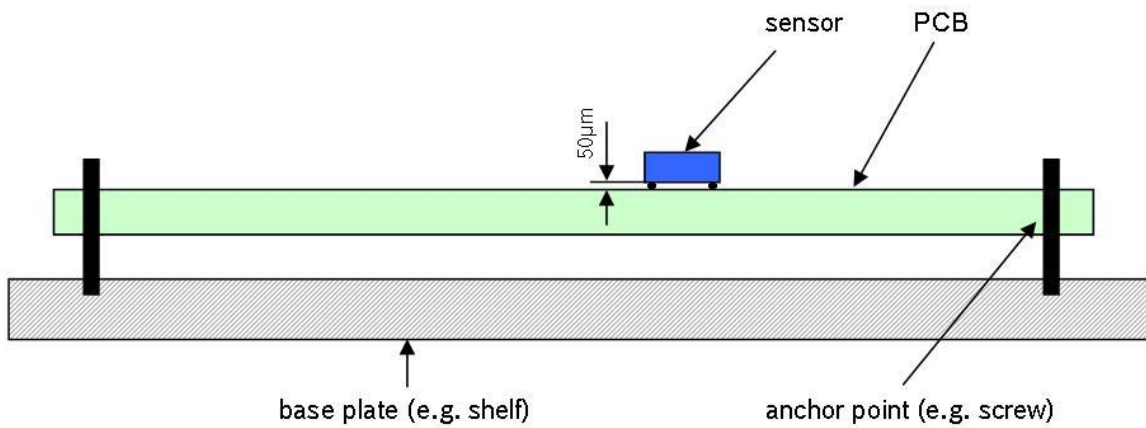

Please avoid all kinds of foreign materials under the sensor, e.g. underfill and cleaning materials.

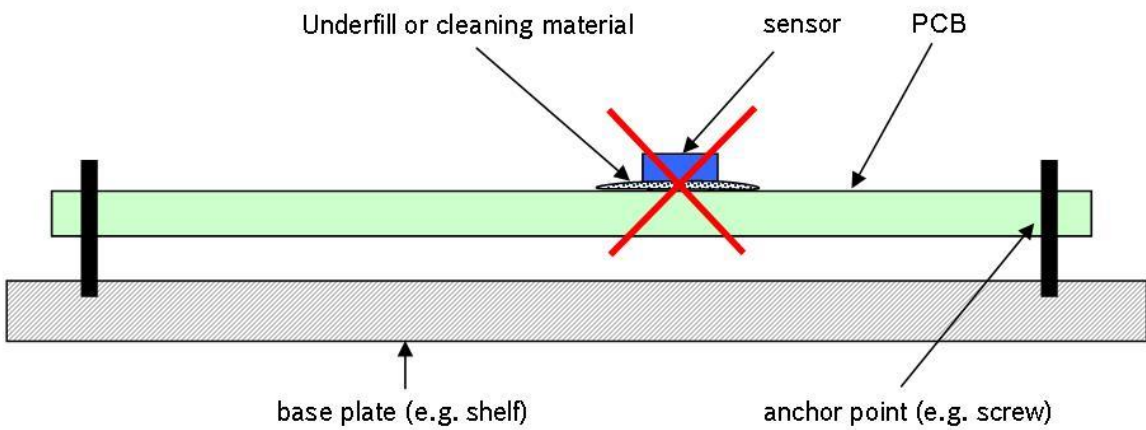

5.10. Redundant PCB anchor points

It is recommended to unscrew or remove any redundant PCB anchor points. In theory, an ideal flat plane is determined by 3 anchor points, exclusively. Any further anchor point will over-determine the ideal flat plane criteria. If these redundant anchor points are out of plane position (which means not 100% exact in plane position) the ideal flat criteria is infringed, resulting in mechanical stress.

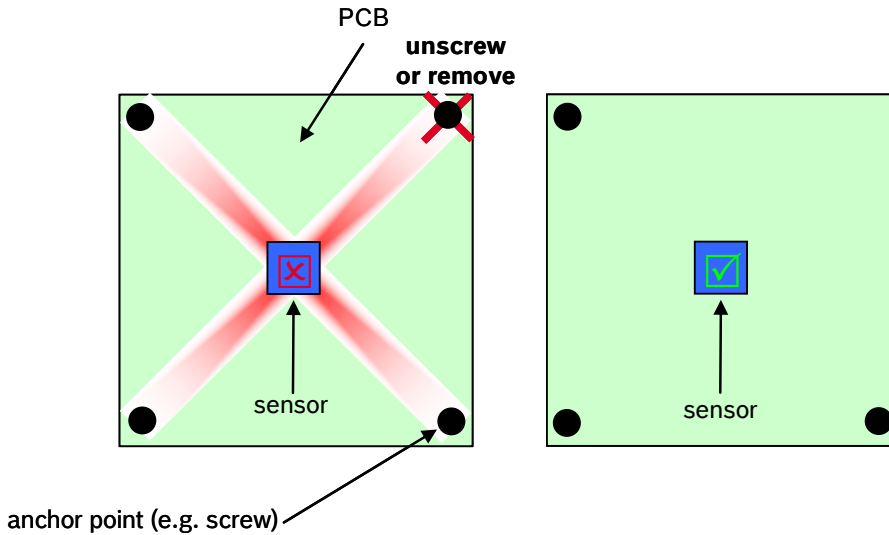

5.11. Mechanical stress maximum on the PCB

It is recommended to keep a reasonable distance from any mechanical stress maximum, when placing the sensor device. Mechanical stress can be induced for example by redundant anchor points, as described in 7.1.7.

The below given example will show a stress maximum in the center of the diagonal crossover of the 4 anchor points. It is good manufacturing praxis to always avoid or reduce the mechanical stress by optimizing the PCB design first, then to place the sensor in an appropriate low stress area.

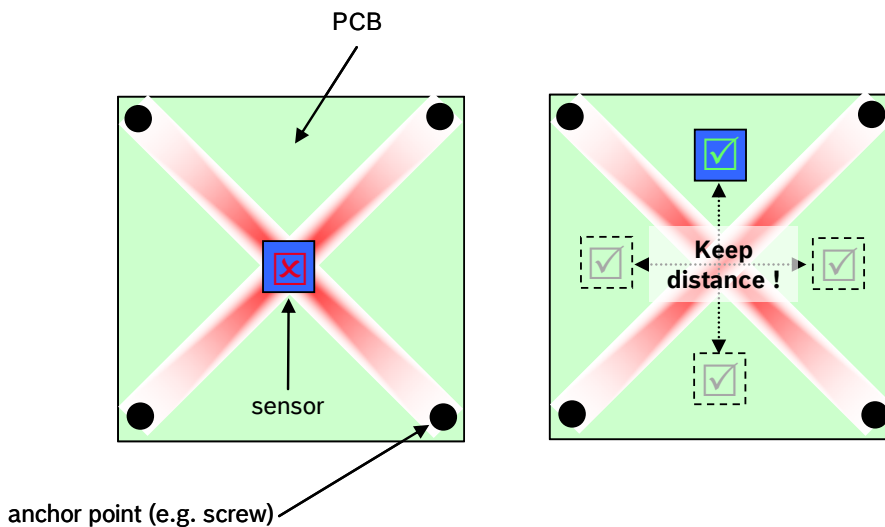

6. Legal disclaimer

6.1. Engineering samples

Engineering Samples are marked with an asterisk (*) or (e). Samples may vary from the valid technical specifications of the product series contained in this data sheet. They are therefore not intended or fit for resale to third parties or for use in end products. Their sole purpose is internal client testing. The testing of an engineering sample may in no way replace the testing of a product series. Bosch Sensortec assumes no liability for the use of engineering samples. The Purchaser shall indemnify Bosch Sensortec from all claims arising from the use of engineering samples.

6.2. Product use

Bosch Sensortec products are developed for the consumer goods industry. They may only be used within the parameters of this product data sheet. They are not fit for use in life-sustaining or security sensitive systems. Security sensitive systems are those for which a malfunction is expected to lead to bodily harm or significant property damage. In addition, they are not fit for use in products which interact with motor vehicle systems.

The resale and/or use of products are at the purchaser's own risk and his own responsibility. The examination of fitness for the intended use is the sole responsibility of the Purchaser.

The purchaser shall indemnify Bosch Sensortec from all third party claims arising from any product use not covered by the parameters of this product data sheet or not approved by Bosch Sensortec and reimburse Bosch Sensortec for all costs in connection with such claims.

The purchaser must monitor the market for the purchased products, particularly with regard to product safety, and inform Bosch Sensortec without delay of all security relevant incidents.

6.3. Application examples and hints

With respect to any examples or hints given herein, any typical values stated herein and/or any information regarding the application of the device, Bosch Sensortec hereby disclaims any and all warranties and liabilities of any kind, including without limitation warranties of non-infringement of intellectual property rights or copyrights of any third party. The information given in this document shall in no event be regarded as a guarantee of conditions or characteristics. They are provided for illustrative purposes only and no evaluation regarding infringement of intellectual property rights or copyrights or regarding functionality, performance or error has been made.

7. Document history and modification

Rev. No	Chapter	Description of modification/changes	Date
1.7		Official version for open market	11 October 2016
1.8			29 May 2018

Bosch Sensortec GmbH
Gerhard-Kindler-Straße 9
72770 Reutlingen / Germany

contact@bosch-sensortec.com
www.bosch-sensortec.com

Modifications reserved
Specifications subject to change without notice
Document number: BST-BME280-HS006-00
Revision_1.8