



Is Now Part of



ON Semiconductor®

To learn more about ON Semiconductor, please visit our website at
www.onsemi.com

Please note: As part of the Fairchild Semiconductor integration, some of the Fairchild orderable part numbers will need to change in order to meet ON Semiconductor's system requirements. Since the ON Semiconductor product management systems do not have the ability to manage part nomenclature that utilizes an underscore (_), the underscore (_) in the Fairchild part numbers will be changed to a dash (-). This document may contain device numbers with an underscore (_). Please check the ON Semiconductor website to verify the updated device numbers. The most current and up-to-date ordering information can be found at www.onsemi.com. Please email any questions regarding the system integration to Fairchild_questions@onsemi.com.

ON Semiconductor and the ON Semiconductor logo are trademarks of Semiconductor Components Industries, LLC dba ON Semiconductor or its subsidiaries in the United States and/or other countries. ON Semiconductor owns the rights to a number of patents, trademarks, copyrights, trade secrets, and other intellectual property. A listing of ON Semiconductor's product/patent coverage may be accessed at www.onsemi.com/site/pdf/Patent-Marking.pdf. ON Semiconductor reserves the right to make changes without further notice to any products herein. ON Semiconductor makes no warranty, representation or guarantee regarding the suitability of its products for any particular purpose, nor does ON Semiconductor assume any liability arising out of the application or use of any product or circuit, and specifically disclaims any and all liability, including without limitation special, consequential or incidental damages. Buyer is responsible for its products and applications using ON Semiconductor products, including compliance with all laws, regulations and safety requirements or standards, regardless of any support or applications information provided by ON Semiconductor. "Typical" parameters which may be provided in ON Semiconductor data sheets and/or specifications can and do vary in different applications and actual performance may vary over time. All operating parameters, including "Typicals" must be validated for each customer application by customer's technical experts. ON Semiconductor does not convey any license under its patent rights nor the rights of others. ON Semiconductor products are not designed, intended, or authorized for use as a critical component in life support systems or any FDA Class 3 medical devices or medical devices with a same or similar classification in a foreign jurisdiction or any devices intended for implantation in the human body. Should Buyer purchase or use ON Semiconductor products for any such unintended or unauthorized application, Buyer shall indemnify and hold ON Semiconductor and its officers, employees, subsidiaries, affiliates, and distributors harmless against all claims, costs, damages, and expenses, and reasonable attorney fees arising out of, directly or indirectly, any claim of personal injury or death associated with such unintended or unauthorized use, even if such claim alleges that ON Semiconductor was negligent regarding the design or manufacture of the part. ON Semiconductor is an Equal Opportunity/Affirmative Action Employer. This literature is subject to all applicable copyright laws and is not for resale in any manner.



January 2016



FJ15603D NPN Silicon Transistor

Applications

- High Voltage and High Speed Power Switch Application
- Electronic Ballast Application

Features

- Wide Safe Operating Area
- Small Variance in Storage Time
- Built-in Free Wheeling Diode

Equivalent Circuit

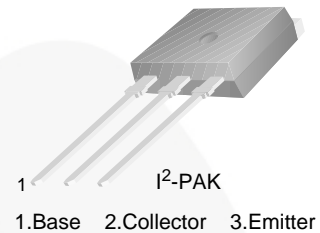
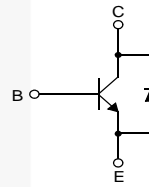

Ordering Information

Part Number	Marking	Package	Packing Method
FJ15603DTU	J5603D	TO-262 3L (I2PAK)	Rail

Absolute Maximum Ratings

Stresses exceeding the absolute maximum ratings may damage the device. The device may not function or be operable above the recommended operating conditions and stressing the parts to these levels is not recommended. In addition, extended exposure to stresses above the recommended operating conditions may affect device reliability. The absolute maximum ratings are stress ratings only. Values are at $T_A = 25^\circ\text{C}$ unless otherwise noted.

Symbol	Parameter	Value	Unit
V_{CBO}	Collector-Base Voltage	1600	V
V_{CEO}	Collector-Emitter Voltage	800	V
V_{EBO}	Emitter-Base Voltage	12	V
I_C	Collector Current (DC)	3	A
I_{CP}	Collector Current (Pulse) ⁽¹⁾	6	A
I_B	Base Current (DC)	2	A
I_{BP}	Base Current (Pulse) ⁽¹⁾	4	A
P_C	Power Dissipation ($T_C = 25^\circ\text{C}$)	100	W
T_J	Junction Temperature	150	$^\circ\text{C}$
T_{STG}	Storage Junction Temperature Range	-65 to +150	$^\circ\text{C}$
EAS	Avalanche Energy ($T_J = 25^\circ\text{C}$, 8 mH)	3.5	mJ

Notes:

1. Pulse test: pulse width = 5 ms, duty cycle $\leq 10\%$

Thermal Characteristics⁽²⁾

Values are at $T_A = 25^\circ\text{C}$ unless otherwise noted.

Symbol	Parameter	Rating	Unit
$R_{\theta JC}$	Thermal Resistance, Junction-to-Case	1.25	$^\circ\text{C/W}$
$R_{\theta JA}$	Thermal Resistance, Junction-to-Ambient	80	$^\circ\text{C/W}$

Note:

2. Device mounted on minimum pad size.

Electrical Characteristics⁽³⁾

Values are at $T_A = 25^\circ\text{C}$ unless otherwise noted.

Symbol	Parameter	Conditions	Min.	Typ.	Max.	Unit	
BV_{CBO}	Collector-Base Breakdown Voltage	$I_C = 0.5\text{ mA}, I_E = 0$	1600	1689		V	
BV_{CEO}	Collector-Emitter Breakdown Voltage	$I_C = 5\text{ mA}, I_B = 0$	800	870		V	
BV_{EBO}	Emitter-Base Breakdown Voltage	$I_E = 0.5\text{ mA}, I_C = 0$	12.0	14.8		V	
I_{CES}	Collector Cut-Off Current	$V_{CE} = 1600\text{ V}, V_{BE} = 0$	$T_C = 25^\circ\text{C}$	0.01	100	μA	
			$T_C = 125^\circ\text{C}$		1000		
I_{CEO}	Collector Cut-Off Current	$V_{CE} = 800\text{ V}, I_B = 0$	$T_C = 25^\circ\text{C}$	0.01	100	μA	
			$T_C = 125^\circ\text{C}$		1000		
I_{EBO}	Emitter Cut-Off Current	$V_{EB} = 12\text{ V}, I_C = 0$		0.05	500	μA	
h_{FE}	DC Current Gain	$V_{CE} = 3\text{ V}, I_C = 0.4\text{ A}$	$T_C = 25^\circ\text{C}$	20	29	35	
			$T_C = 125^\circ\text{C}$	6	15		
		$V_{CE} = 10\text{ V}, I_C = 5\text{ mA}$	$T_C = 25^\circ\text{C}$	20	43		
			$T_C = 125^\circ\text{C}$	20	46		
$V_{CE(sat)}$	Collector-Emitter Saturation Voltage	$I_C = 250\text{ mA}, I_B = 25\text{ mA}$		0.50	1.25	V	
		$I_C = 500\text{ mA}, I_B = 50\text{ mA}$		1.50	2.50		
		$I_C = 1\text{ A}, I_B = 0.2\text{ A}$		1.20	2.50		
$V_{BE(sat)}$	Base-Emitter Saturation Voltage	$I_C = 500\text{ mA}, I_B = 50\text{ mA}$	$T_C = 25^\circ\text{C}$	0.74	1.20	V	
			$T_C = 125^\circ\text{C}$	0.61	1.10		
		$I_C = 2\text{ A}, I_B = 0.4\text{ A}$	$T_C = 25^\circ\text{C}$	0.85	1.20		
			$T_C = 125^\circ\text{C}$	0.74	1.10		
C_{ib}	Input Capacitance	$V_{EB} = 10\text{ V}, I_C = 0, f = 1\text{ MHz}$		745	1000	pF	
C_{ob}	Output Capacitance	$V_{CB} = 10\text{ V}, I_E = 0, f = 1\text{ MHz}$		56	500	pF	
f_T	Current Gain Bandwidth Product	$I_C = 0.1\text{ A}, V_{CE} = 10\text{ V}$		5		MHz	
V_F	Diode Forward Voltage	$I_F = 0.4\text{ A}$		0.76	1.20	V	
		$I_F = 1\text{ A}$		0.83	1.50		

Note:

3. Pulse test: pulse width = 20 μs , duty cycle $\leq 10\%$.

Electrical Characteristics (Continued)Values are at $T_A = 25^\circ\text{C}$ unless otherwise noted.

Symbol	Parameter	Conditions	Min.	Typ.	Max.	Unit
RESISTIVE LOAD SWITCHING (D.C. \leq 10%, Pulse Width = 20 μs)						
t_{ON}	Turn-On Time	$I_C = 0.3\text{ A}$, $I_{B1} = 50\text{ mA}$, $I_{B2} = 150\text{ mA}$, $V_{CC} = 125\text{ V}$, $R_L = 416\ \Omega$		400	600	ns
t_{STG}	Storage Time		1.9	2.1	2.3	μs
t_F	Fall Time			310	1000	ns
t_{ON}	Turn-On Time	$I_C = 0.5\text{ A}$, $I_{B1} = 50\text{ mA}$, $I_{B2} = 250\text{ mA}$, $V_{CC} = 125\text{ V}$, $R_L = 250\ \Omega$		600	1100	ns
t_{STG}	Storage Time			1.3	1.5	μs
t_F	Fall Time			180	350	ns
INDUCTIVE LOAD SWITCHING ($V_{CC} = 15\text{ V}$)						
t_{STG}	Storage Time	$I_C = 0.3\text{ A}$, $I_{B1} = 50\text{ mA}$, $I_{B2} = 150\text{ mA}$, $V_Z = 300\text{ V}$, $L_C = 200\text{ H}$	0.8		1.2	μs
t_F	Fall Time			170	250	ns
t_C	Cross-Over Time			180	250	ns
t_{STG}	Storage Time	$I_C = 0.5\text{ A}$, $I_{B1} = 50\text{ mA}$, $I_{B2} = 250\text{ mA}$, $V_Z = 300\text{ V}$, $L_C = 200\text{ H}$	0.8		1.2	μs
t_F	Fall Time			140	175	ns
t_C	Cross-Over Time			170	200	ns

Typical Performance Characteristics

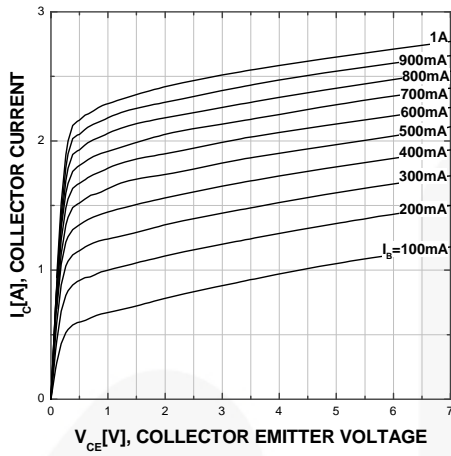

Figure 1. Static Characteristic

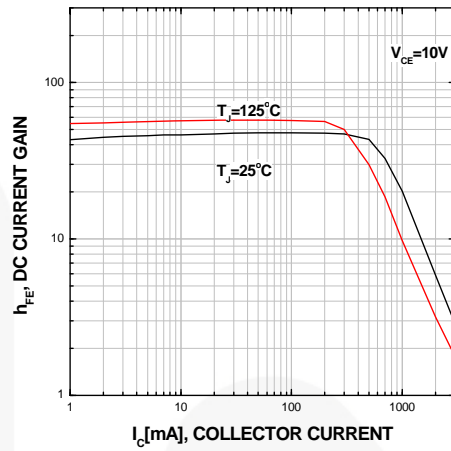

Figure 2. DC Current Gain

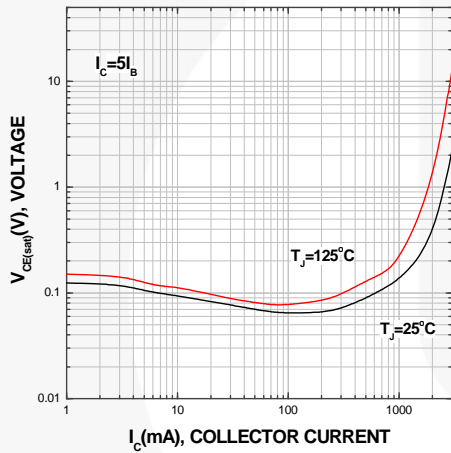

Figure 3. Collector-Emitter Saturation Voltage

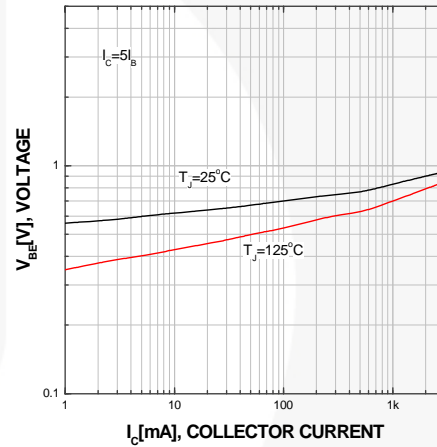

Figure 4. Base-Emitter Saturation Voltage

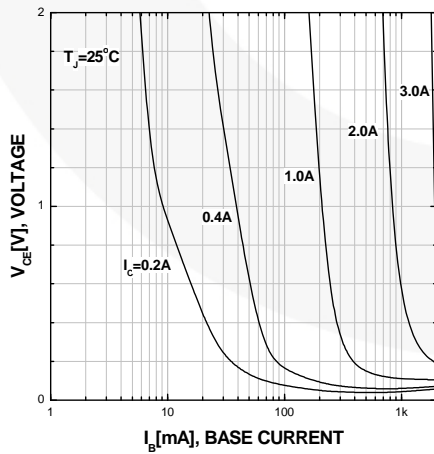

Figure 5. Typical Collector Saturation Voltage

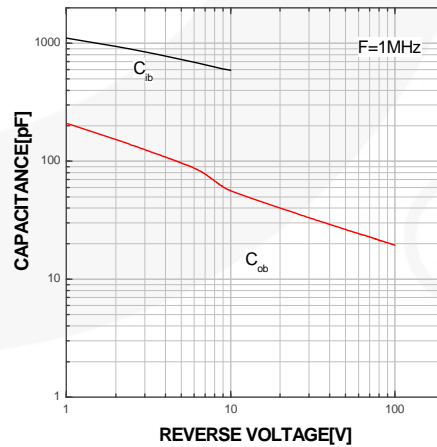

Figure 6. Capacitance

Typical Performance Characteristics (Continued)

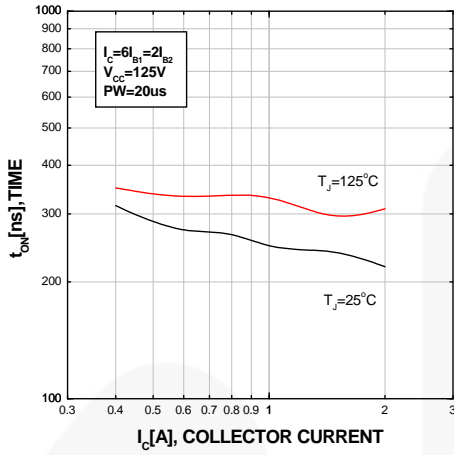

Figure 7. Resistive Switching Time, t_{on}

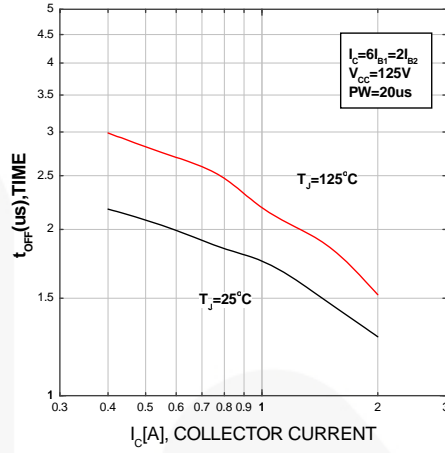

Figure 8. Resistive Switching Time, t_{off}

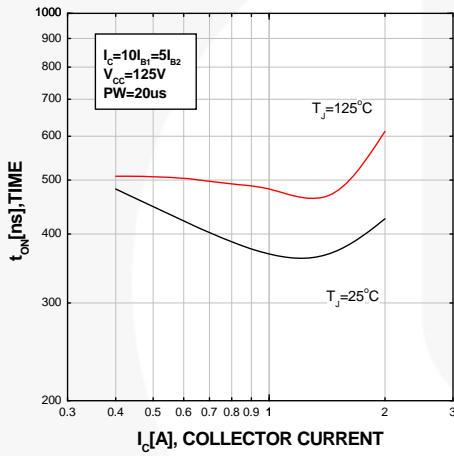

Figure 9. Resistive Switching Time, t_{on}

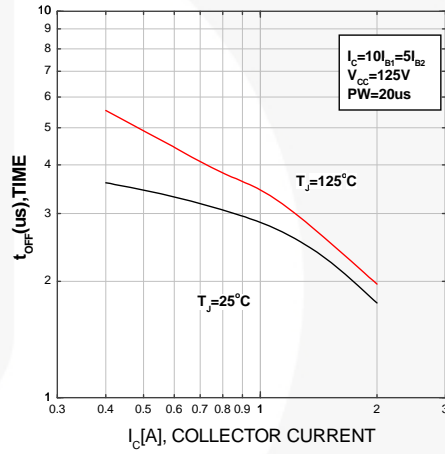

Figure 10. Resistive Switching Time, t_{off}

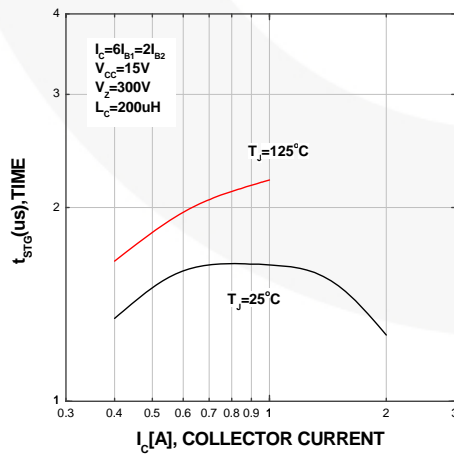

Figure 11. Inductive Switching Time, t_{STG}

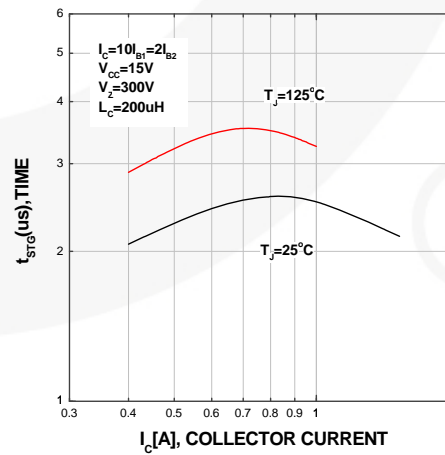

Figure 12. Inductive Switching Time, t_{STG}

Typical Performance Characteristics (Continued)

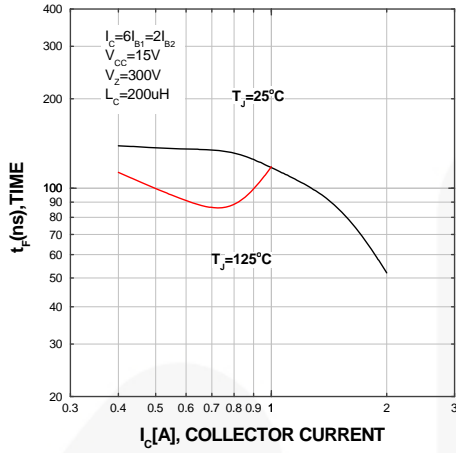

Figure 13. Inductive Switching Time, t_f

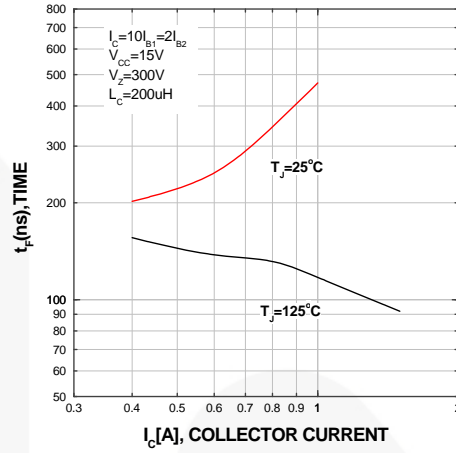

Figure 14. Inductive Switching Time, t_f

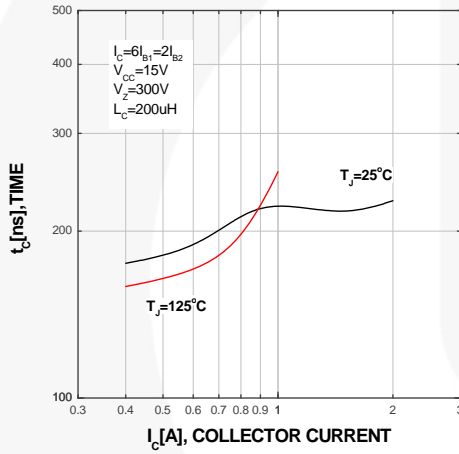

Figure 15. Inductive Switching Time, t_c

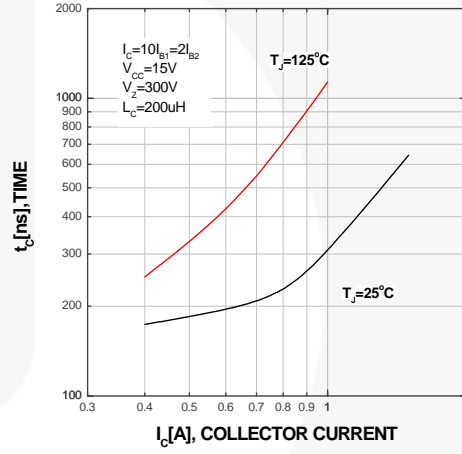

Figure 16. Inductive Switching Time, t_c

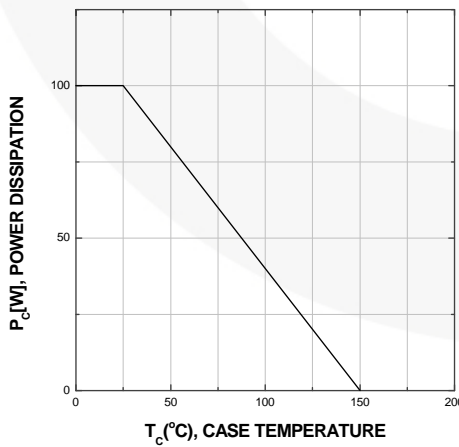
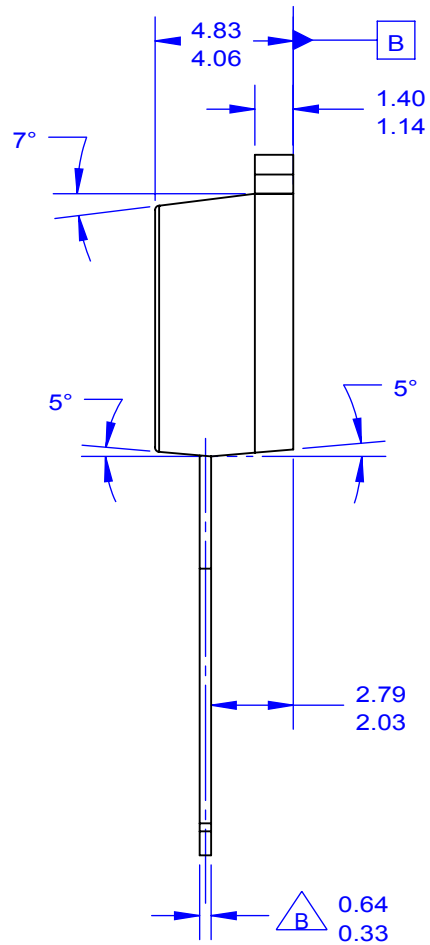
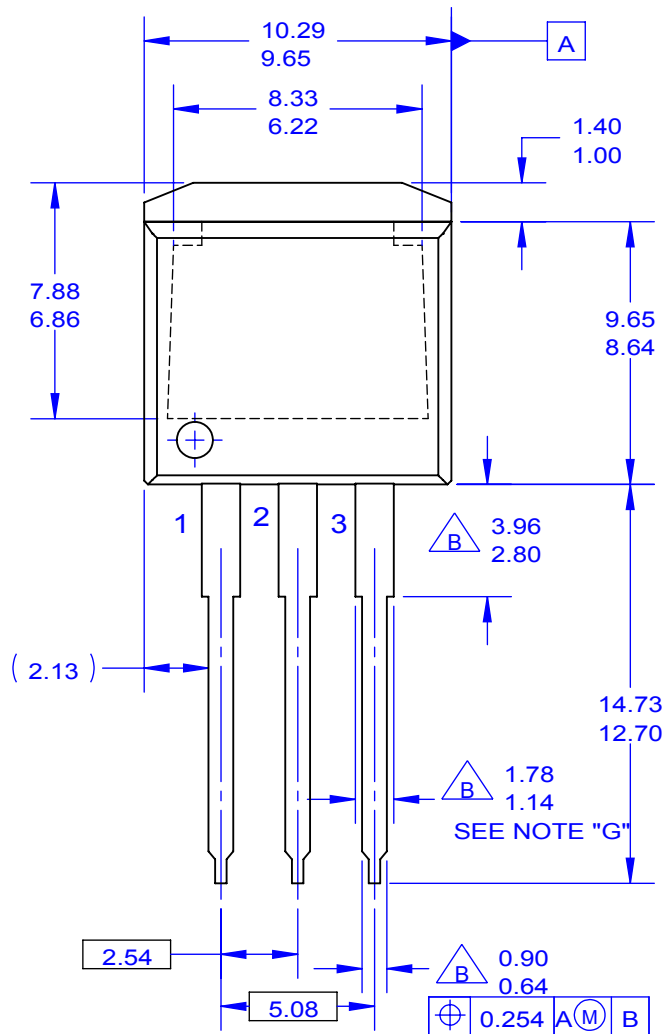

Figure 17. Power Derating



NOTES:

- A. EXCEPT WHERE NOTED CONFORMS TO TO262 JEDEC VARIATION AA.
- B. DOES NOT COMPLY JEDEC STD. VALUE.
- C. ALL DIMENSIONS ARE IN MILLIMETERS.
- D. DIMENSIONS ARE EXCLUSIVE OF BURRS, MOLD FLASH AND TIE BAR PROTRUSIONS.
- E. DIMENSION AND TOLERANCE AS PER ANSI Y14.5-1994.
- F. LOCATION OF PIN HOLE MAY VARY (LOWER LEFT CORNER, LOWER CENTER AND CENTER OF PACKAGE)
- G. MAXIMUM WIDTH FOR F102 DEVICE = 1.35 MAX.
- H. DRAWING FILE NAME: TO262A03REV6



ON Semiconductor and  are trademarks of Semiconductor Components Industries, LLC dba ON Semiconductor or its subsidiaries in the United States and/or other countries. ON Semiconductor owns the rights to a number of patents, trademarks, copyrights, trade secrets, and other intellectual property. A listing of ON Semiconductor's product/patent coverage may be accessed at www.onsemi.com/site/pdf/Patent-Marking.pdf. ON Semiconductor reserves the right to make changes without further notice to any products herein. ON Semiconductor makes no warranty, representation or guarantee regarding the suitability of its products for any particular purpose, nor does ON Semiconductor assume any liability arising out of the application or use of any product or circuit, and specifically disclaims any and all liability, including without limitation special, consequential or incidental damages. Buyer is responsible for its products and applications using ON Semiconductor products, including compliance with all laws, regulations and safety requirements or standards, regardless of any support or applications information provided by ON Semiconductor. "Typical" parameters which may be provided in ON Semiconductor data sheets and/or specifications can and do vary in different applications and actual performance may vary over time. All operating parameters, including "Typicals" must be validated for each customer application by customer's technical experts. ON Semiconductor does not convey any license under its patent rights nor the rights of others. ON Semiconductor products are not designed, intended, or authorized for use as a critical component in life support systems or any FDA Class 3 medical devices or medical devices with a same or similar classification in a foreign jurisdiction or any devices intended for implantation in the human body. Should Buyer purchase or use ON Semiconductor products for any such unintended or unauthorized application, Buyer shall indemnify and hold ON Semiconductor and its officers, employees, subsidiaries, affiliates, and distributors harmless against all claims, costs, damages, and expenses, and reasonable attorney fees arising out of, directly or indirectly, any claim of personal injury or death associated with such unintended or unauthorized use, even if such claim alleges that ON Semiconductor was negligent regarding the design or manufacture of the part. ON Semiconductor is an Equal Opportunity/Affirmative Action Employer. This literature is subject to all applicable copyright laws and is not for resale in any manner.

PUBLICATION ORDERING INFORMATION

LITERATURE FULFILLMENT:

Literature Distribution Center for ON Semiconductor
19521 E. 32nd Pkwy, Aurora, Colorado 80011 USA
Phone: 303-675-2175 or 800-344-3860 Toll Free USA/Canada
Fax: 303-675-2176 or 800-344-3867 Toll Free USA/Canada
Email: orderlit@onsemi.com

N. American Technical Support: 800-282-9855 Toll Free
USA/Canada
Europe, Middle East and Africa Technical Support:
Phone: 421 33 790 2910
Japan Customer Focus Center
Phone: 81-3-5817-1050

ON Semiconductor Website: www.onsemi.com
Order Literature: <http://www.onsemi.com/orderlit>
For additional information, please contact your local
Sales Representative